

BrightEye 57 3G/HD/SD/Analog Test Signal and Sync Pulse Generator

User Guide

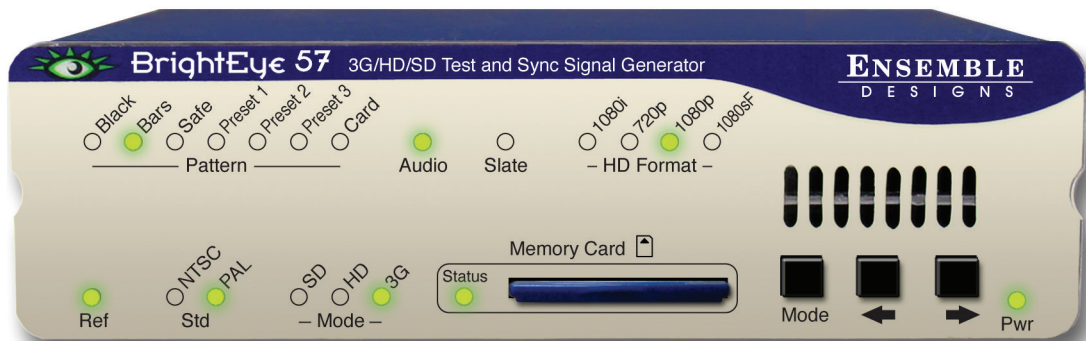

Revision 1.3 SW v1.2.1

ENSEMBLE

DESIGNS

Purveyors of Fine Video Gear—Loved by Engineers Worldwide

Clearly, Ensemble wants to be in the broadcast equipment business. It's so rare anymore to find a company of this caliber that has not been gobbled up by a large corporation. They are privately held so they don't have to please the money people. They really put their efforts into building products and working with customers.

I'm really happy with the BrightEye products and Ensemble's service, and even more important my engineers are happy. We've continued to upgrade the product and add more cards. We will be rebuilding our production control room and we will use BrightEye again.

~ Don McKay, Vice President Engineering, Oregon Public Broadcasting

Who is Ensemble Designs?

By Engineers, For Engineers

In 1989, a former television station engineer who loved designing and building video equipment, decided to start a new company. He relished the idea of taking an existing group of equipment and adding a few special pieces in order to create an even more elegant ensemble. So, he designed and built his first product and the company was born.



BrightEye frames handle 270 Mb/s, 1.5 Gb/s and 3 Gb/s signals, audio and MPEG signals. Used worldwide in broadcast, mobile, production, and post.

Focused On What You Need

As the company has grown, more former TV station engineers have joined Ensemble Designs and this wealth of practical experience fuels the company's innovation. Everyone at the company is focused on providing the very equipment you need to complete your ensemble of video and audio gear. We offer those special pieces that tie everything together so that when combined, the whole ensemble is exactly what you need.

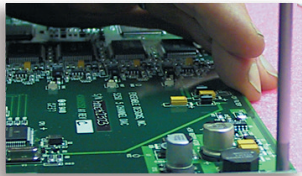

We're focused on processing gear—3G/HD/SD/ASI video, audio and optical units.

Notably Great Service for You

We listen to you – just tell us what you need and we'll do our best to build it. We are completely focused on you and the equipment you need. Being privately held means we don't have to worry about a big board of directors or anything else that might take attention away from real business. And, you can be sure that when you call a real person will answer the phone. We love this business and we're here to stay.



Come on by and visit us. Drop in for lunch and a tour!

Bricks and Mortar of Your Facility

The bricks and mortar of a facility include pieces like up/downconverters, audio embedders, video converters, routers, protection switches and SPGs for SD, HD and 3 Gb/s. That's what we're focused on, that's all we do – we make proven and reliable signal processing and infrastructure gear for broadcasters worldwide, for you.



Shipped with care to television broadcasters and video facilities all over the world.



Contents

Product Overview	5
Sync Generator and Test Signal Generator	5
3G Support	5
3G Signal Chain Options	5
Outputs	5
Customizable Test Patterns	5
Adjustments and Controls	5
Tri Level Sync	6
Tone Generator Locked to Master Clock or External Reference	6
Configurable Tone Generator	6
Internal Timecode Generator	6
Functional Description	7
External House Reference or Internal Precision Standard Reference	7
Temperature Compensated Oscillator	7
Block Diagram	8
Timecode Generator	10
Outputting Timecode	10
Table: Timecode Output Types and Output Connectors	11
Table: SDI Output Selections and Corresponding Timecode	12
Audio Generation and Routing	13
Audio Generators	13
Sixteen Independently Programmable Audio Channels	13
Audio Embedded in the SDI Outputs	13
Support for Analog and Digital Audio	13
Applications	16
Analog, HD SDI and Audio Reference Outputs	16
Genlocked Test Signals	17
Rear Connectors	18
Power Connection	18
USB Connector	18

Audio Out	18
<i>Balanced Analog Audio Connection</i>	19
<i>For Unbalanced Audio to a RCA Phono Input</i>	19
AES 1/2 Out	19
TLS Out	19
SDI Out	19
SD Composite Out	19
Ref In (Reference In)	20
Programmable Outputs	20
Module Configuration and Control	21
Front Panel Controls and Indicators	21
<i>Status Indicators</i>	21
Adjusting Parameters from the Front Panel	22
Using the BrightEye Control Application	23
Format Menu	23
Pattern Menu	24
SDI Out Menu	26
Cpst Out Menu	27
TLS Menu	28
Audio Menu	29
Timecode Menu	31
Aux Out Menu	32
Config Menu	33
Storage Menu	34
Troubleshooting	35
No signal output	35
Software Updating	36
Warranty and Factory Service	36
Warranty	36
Factory Service	36
Specifications	37
Glossary	39

Product Overview

Sync Generator and Test Signal Generator

The BrightEye 57 is a genlockable sync generator and test signal generator that can be used as either a slave or master reference generator. It can lock to house reference or it can lock to its own internal precision standard. BrightEye 57 is well suited for remote trucks, post, helicopters and fly packs.

3G Support

The BrightEye 57's 3G test signals are useful for facilities that are installing 3 Gb/s routers and signal distribution. At twice the bit rate as HD SDI, 3G can transmit 1080p (50 or 59.94) and 4:4:4 RGB signals on a single cable. BrightEye 57 is compliant with SMPTE 424M and 425M and has support for both Level A and Level B. 3G Level A is used for uncompressed 1080p 50/60 signals, useful in broadcast and satellite. 3G Level B is used for uncompressed 1080i 4:4:4 and is useful in post production.

3G Signal Chain Options

For facilities and manufacturers using 3 Gb/s video, BrightEye units can be combined to form a complete 3G signal chain. The BrightEye 57 test signal generator's 3G output can be distributed through the BrightEye 43 3G distribution amplifier or the BrightEye 46 and BrightEye 48 E/O 3G fiber optical transmitter/receiver set. The BrightEye 72 provides a convenient way to monitor 3G signals with analog and HDMI outputs.

Outputs

The SDI Outputs 1 and 2 provide 1.5 Gb/s HD, 3 Gb/s HD or SD SDI test signals or black with embedded audio. There are also outputs for Composite, Tri Level Sync and AES digital audio. There are three user-programmable outputs that are selectable between AES, LTC, Word clock or 6 Hz Pulse. Analog audio and AES outputs provide tone or silence.

The SDI and analog composite outputs provide simultaneously available signals including Color Black, Bars, Crosshatch, Multi-burst, and SDI Checkfield (Pathogenic). The Cyclops feature adds a motion element to the selected video test signal. An ID slate with user-programmable text can overlay the test pattern.

Customizable Test Patterns

In addition to the standard suite of test patterns, users can create custom test patterns on a computer. Transfer test patterns to the included Secure Digital flash memory card and then insert the memory card into the front of the BrightEye 57. Test patterns can include motion and an associated audio clip such as voice-over or station ID.

Note: Use Ensemble Design's Pattern Generator software application when creating custom test patterns for the BrightEye 57. Please see the [BrightEye Support page](#) for the link to download this software. See also the [Pattern Generator User Guide](#).

Adjustments and Controls

Many controls can be adjusted through the intuitive front panel. BrightEye Mac and BrightEye PC software (version 2.1.2 or later) provide a complete user interface for all adjustments and controls.

Tri Level Sync

Tri Level Sync offers improved timing accuracy over traditional Bi-Level Sync. The analog output of a standard sync generator is Bi-Level Sync. The timing reference is the 50% point of the leading edge. The relative timing of this point shifts with changes in gain, DC reference, and frequency response.

The timing reference in Tri Level Sync is also at the 50% point of the sync pulse, but because this pulse has both the positive and negative excursions, this point is the same as the DC ground reference. This symmetry makes the signal virtually immune to time shift from gain, DC and response errors. The zero point never drifts. The zero crossing is easy to detect every time which ensures timing accuracy.

The Tri Level Sync Generator block is configured in the BrightEye Control application to one of four HD formats (1080i, 1080p, 720p, or 1080sF). The Tri Level Sync output frame rate can be selected between 23.98/50/59.94, the most commonly used family of frame rates, and 24/30/60, reserved for use with special applications such as film.

The BrightEye 57 will apply the selected TLS frame rates to specific formats and line rates as shown in the table below.

Frame Rate	23.98/50/59.94 Hz		24/30/60 Hz	
Line Rate	NTSC	PAL	NTSC	PAL
1080i	59.94	50	60	50
720p	59.94	50	60	50
1080p	23.98	25	24	25
1080sF	23.98	25	24	25

Tone Generator Locked to Master Clock or External Reference

The Tone Generator is also locked to the master clock or the external reference, so the 48 kHz AES output will be synchronous to the video outputs. In NTSC there are exactly 8008 audio samples in every five video frames. There will be exactly 1920 audio samples in every PAL video frame.

Configurable Tone Generator

The Tone Generator can be configured for silence, a continuous tone, or an interrupted tone which is coordinated with the Cyclops moving element. The Tone Generator feeds the Analog Audio outputs through a precision digital-to-analog converter. It feeds an AES formatter to produce a standard AES output. And finally, it is fed to an embedder (audio inserter) so that it will also be a part of the SDI outputs.

Internal Timecode Generator

The internal Timecode Generator feeds DVITC on the SDI outputs and VITC on the composite outputs. Timecode can also be selected in LTC form on the programmable Aux 1, Aux 2, and Aux 3 outputs.

Functional Description

External House Reference or Internal Precision Standard Reference

The BrightEye 57 can lock to an external house reference or it can lock to its own internal precision standard reference.

The Ref In BNC on the rear of the unit will accept 1 V P-P PAL, NTSC, 10 MHz or Tri Level Sync as a reference. The outputs will all be synchronous relative to this reference. The overall vertical and horizontal timing of the outputs can be adjusted in the BrightEye PC or Mac Timing menu. Reference status is reported on the front of the unit and in BrightEye PC or Mac. The Composite video output will have the same ScH phase (or color framing) as the external reference.

A special case exists when simultaneously using PAL and NTSC. If the output standard for the module is PAL and an NTSC reference is connected, BrightEye 57 will lock to the reference at the fundamental clock frequency common to PAL and NTSC. This is referred to as “clock-locked.” There is no horizontal and vertical relationship but BrightEye 57 will have the same frequency accuracy as the reference and the AES audio output will be synchronous simultaneously to the BrightEye 57 PAL output and the NTSC reference. The same case is true for an NTSC standard with a PAL reference.

Temperature Compensated Oscillator

When no external reference is connected to the unit, the fundamental clock source for BrightEye 57 is taken from a temperature compensated oscillator which guarantees frequency accuracy to within 1 cycle of subcarrier (better than 0.2 ppm) across the full operating temperature range. In addition, because it does not require a crystal oven, BrightEye 57 is accurate immediately upon power up. This ensures that the BrightEye 57 outputs meet the most stringent standards.

Block Diagram

Please see the functional block diagram on this page and the next page. The block diagram appears twice, first in a portrait view, then larger in a landscape view.

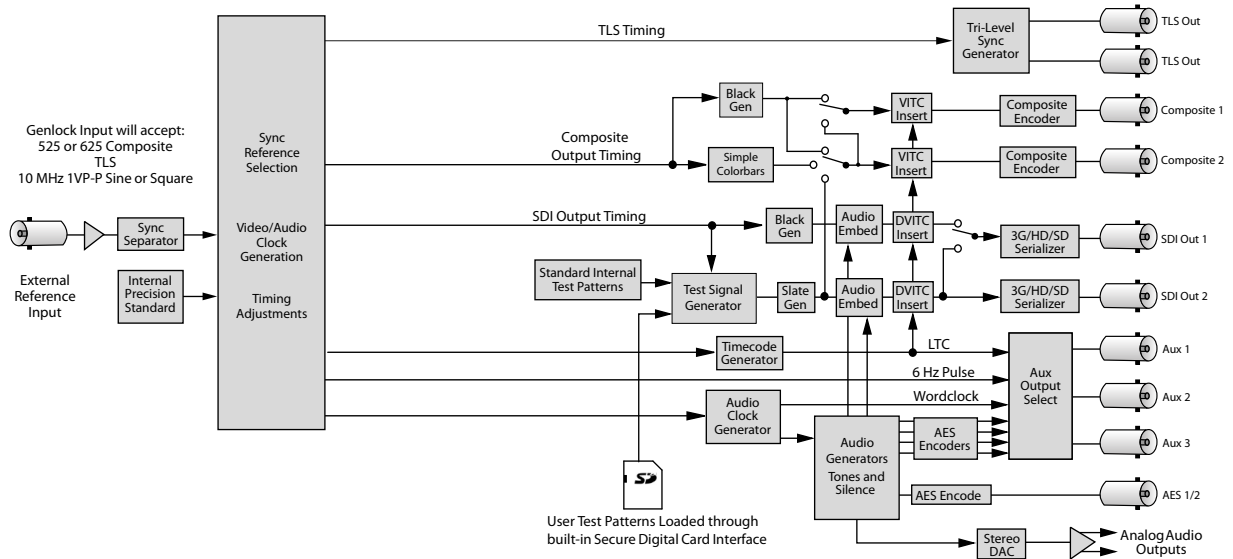

BrightEye 57 Functional Block Diagram, Portrait View

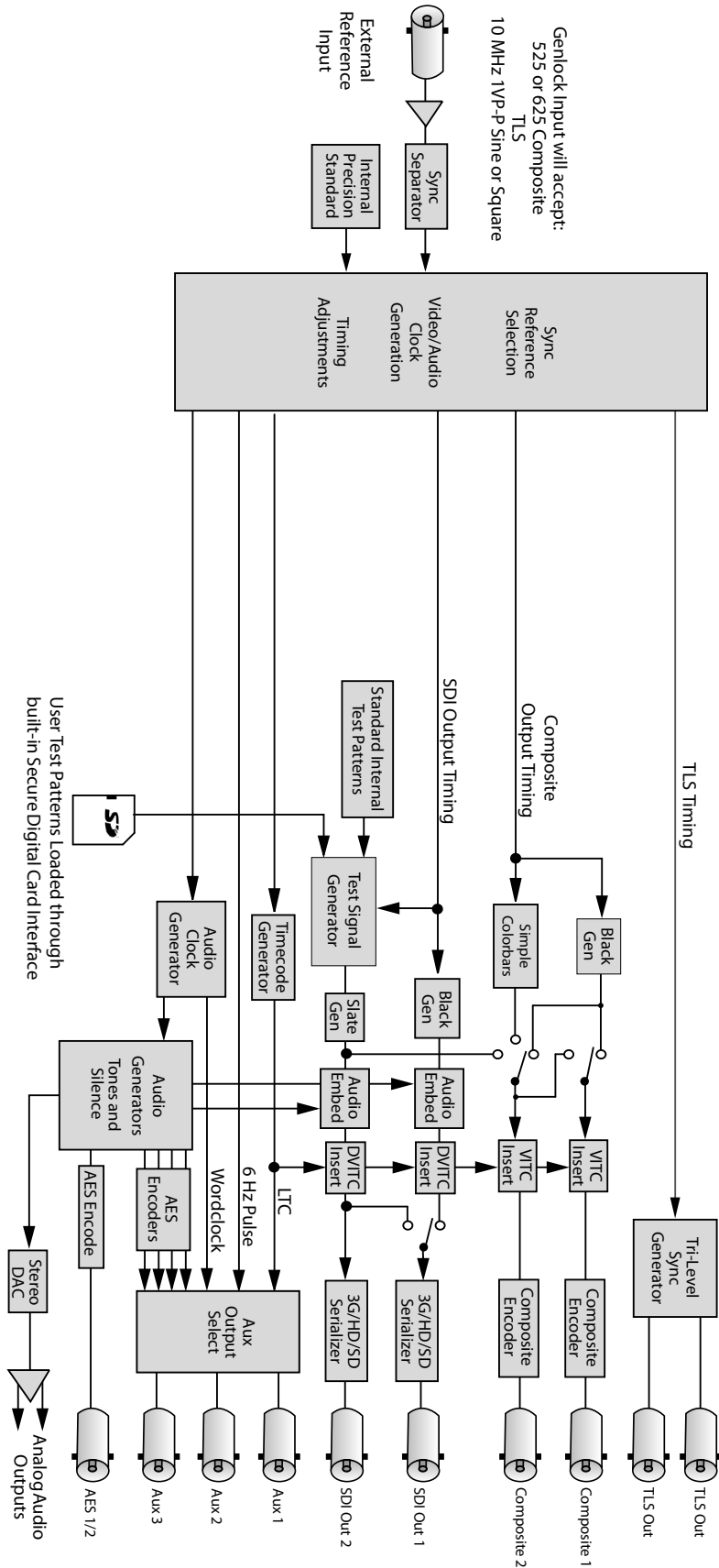

BrightEye 57 Functional Block Diagram, Landscape View

Timecode Generator

The output of the BrightEye 57's Timecode Generator is available simultaneously in multiple output types through multiple output connectors as shown in the **Timecode Output Types and Output Connectors** table on the next page.

The Timecode Generator will always run at the same frame rate as the main SDI outputs. If that output is in the NTSC family (29.97 or 59.94), you can configure for the choice of Drop Frame or non-Drop Frame operation. Drop Frame is necessary if you want the timecode value to track the actual time of day. By dropping specific frames, it makes up for the fact that the frame rate is just shy (by 1/1.001) of 60 Hz.

You can load the Timecode Generator with a preset value through the control system. When a BrightEye 57 powers up, the Timecode Generator starts at 0:0:0:0. Alternatively, the BrightEye 57 can read VITC present on the reference input. This timecode value will be used continuously by the BrightEye 57's internal generator. When this option is selected, the timecode presented on the many different outputs will all match the timecode on the reference input.

Outputting Timecode

The BrightEye 57 has one timecode generator. The timecode that it produces can be output through a number of methods:

1. Routing LTC (linear timecode) to one of the Programmable Output BNCs (Aux 1, Aux 2, Aux 3). This is an analog, unbalanced, single-ended 1V P-P signal at 75 Ohm impedance.
2. Routing LTC to the Analog Audio Output connector. This will be exactly the same signal as when it is routed to a BNC, but it will be a differential (balanced) twisted pair analog signal coming out of the green Phoenix connector on the rear of the unit. Choose Timecode LTC on one of the 16 audio channel selectors, then route that audio to the Analog Audio Output connector.
3. Routing LTC as an audio channel in an AES bitstream. Choose Timecode LTC on one of the audio channel selectors, then select AES on any of the Programmable Outputs (Aux 1, Aux 2, Aux 3). There are 9 different AES choices which correspond to channel pairs 1/2, 3/4, 5/6, etc, and the choice of AES Silence. Choose the appropriate audio pair so that the particular AES stream being fed to an output includes the timecode signal.
4. Routing LTC as one of the audio signals embedded in the SDI Output stream.
5. Routing VITC (vertical interval timecode) on an analog composite output.
6. Routing DVITC (digital vertical interval timecode) on an SD SDI output.
7. Routing ATC (ancillary timecode) on an HD SDI output.

You can output an analog timecode signal with any of the methods described above. The difference between them is a choice between balanced or unbalanced. If you need to feed timecode to a device with an XLR input, you would generally want to use the balanced output. However, it is also possible to use the unbalanced output through Programmable Outputs (Aux 1, Aux 2, Aux 3) and connect it to the destination with a balancing transformer. This would be much like the DATS adaptors for AES.

The advantage of using the unbalanced output through the Programmable Outputs (Aux 1, Aux 2, Aux 3) is that you can run it through a BrightEye 41 Distribution Amplifier to make more copies.

Table: Timecode Output Types and Output Connectors

Timecode Output Type	Output Connectors
LTC (Linear or Longitudinal Timecode) single-ended Note: <i>An LTC signal is a very low data rate bit stream that fits within the bandwidth of an analog audio signal.</i>	Aux 1, Aux 2, Aux 3
LTC balanced	One of the two Analog Audio Outputs (Channel 1 or Channel 2)
LTC embedded in an audio channel	One of the 16 audio channels in the SDI Out (either SD or HD)
VITC (Vertical Interval Timecode)	<p>The vertical interval of the Analog Composite Out. Outputs can be Black or any test signal.</p> <p>SDI Out when it is SD. This is a digitized version of the VITC that would be in an analog composite signal.</p> <p>VITC can be assigned to any of the following line pairs:</p> <ul style="list-style-type: none"> • Lines 13, 15 • Lines 14, 16 • Lines 15, 17 • Lines 16, 18 • Lines 17, 19 • Lines 18, 20
DVITC (Digital Vertical Interval Timecode)	<p>The vertical interval of the SDI Out when it is SD. Outputs can be Black or any test signal.</p> <p>SDI Out when it is HD. Can have DVITC packets carried in the ancillary data spaces.</p> <p>DVITC can be assigned to any of the following line pairs:</p> <ul style="list-style-type: none"> • Lines 13, 15 • Lines 14, 16 • Lines 15, 17 • Lines 16, 18 • Lines 17, 19 • Lines 18, 20
ATC (Ancillary Timecode)	<p>The vertical interval when the output is HD SDI. SDI outputs can be Black or any test signal.</p> <p>There is no concept of line assignment for the ATC packet.</p>

Table: SDI Output Selections and Corresponding Timecode

SDI Output	TC Frame Rate	VITC on SD Output	Drop
720p/59.94	The current SMPTE spec (SMPTE-12M) does not allow >30Hz framerate		
1080i/59.94	29.97 Frames/second	yes	On or Off
1080i/50	25 Frames/second	yes	N/A
1080sF/23.98	23.98 Frames/second	no	On or Off
1080sF/24	24 Frames/second	no	N/A
SD 525	29.97 Frames/second	yes	On or Off
SD 625	25 Frames/second	yes	N/A

Audio Generation and Routing

Audio Generators

The diagram shown on the following two pages depicts the audio signal generation and routing for the BrightEye 57. It appears twice, first in a portrait view, then larger as a landscape view.

Audio can be output as follows:

- Analog audio (one stereo pair)
- AES digital audio (BNC)
- Digital audio embedded in the SD SDI and/or HD SDI video outputs

Sixteen Independently Programmable Audio Channels

The BrightEye 57 supports sixteen audio channels and the content of each channel is independently programmable. Choices include adjustable frequency tone generators, tone sweeps, silence, timecode, audio clip playback from the BrightEye 57's secure digital card, and the external AES input. Left/right channel ID that synchronizes to the cyclops feature can also be selected.

Audio Embedded in the SDI Outputs

All sixteen of these channels can be embedded in the SDI outputs. Each AES output can select from any of the eight pairs that make up these sixteen channels. Similarly, the stereo analog output can be driven from any of these audio signal pairs.

Support for Analog and Digital Audio

The AES digital audio outputs are always synchronous with all of the video outputs – regardless of format – because all of the video outputs can be locked to a common time base. Multiple tone generators can be used to identify multi-channel content. Analog audio is output as one stereo pair or as two mono channels.

BrightEye 56/57
3G/HD/SD Sync Pulse / Test Signal Generator
Audio Generation and Routing

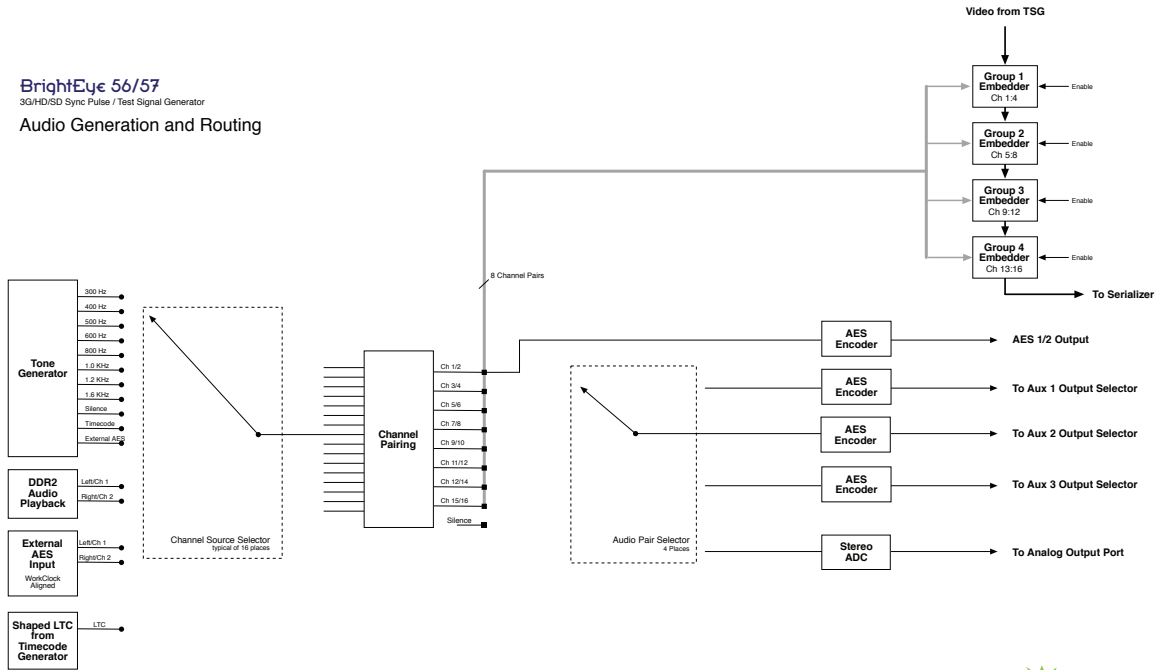

BrightEye 57 Audio Generation and Routing Functional Diagram, Portrait View

BrightEye 56/57
3G/HD/SD Sync Pulse / Test Signal Generator
Audio Generation and Routing

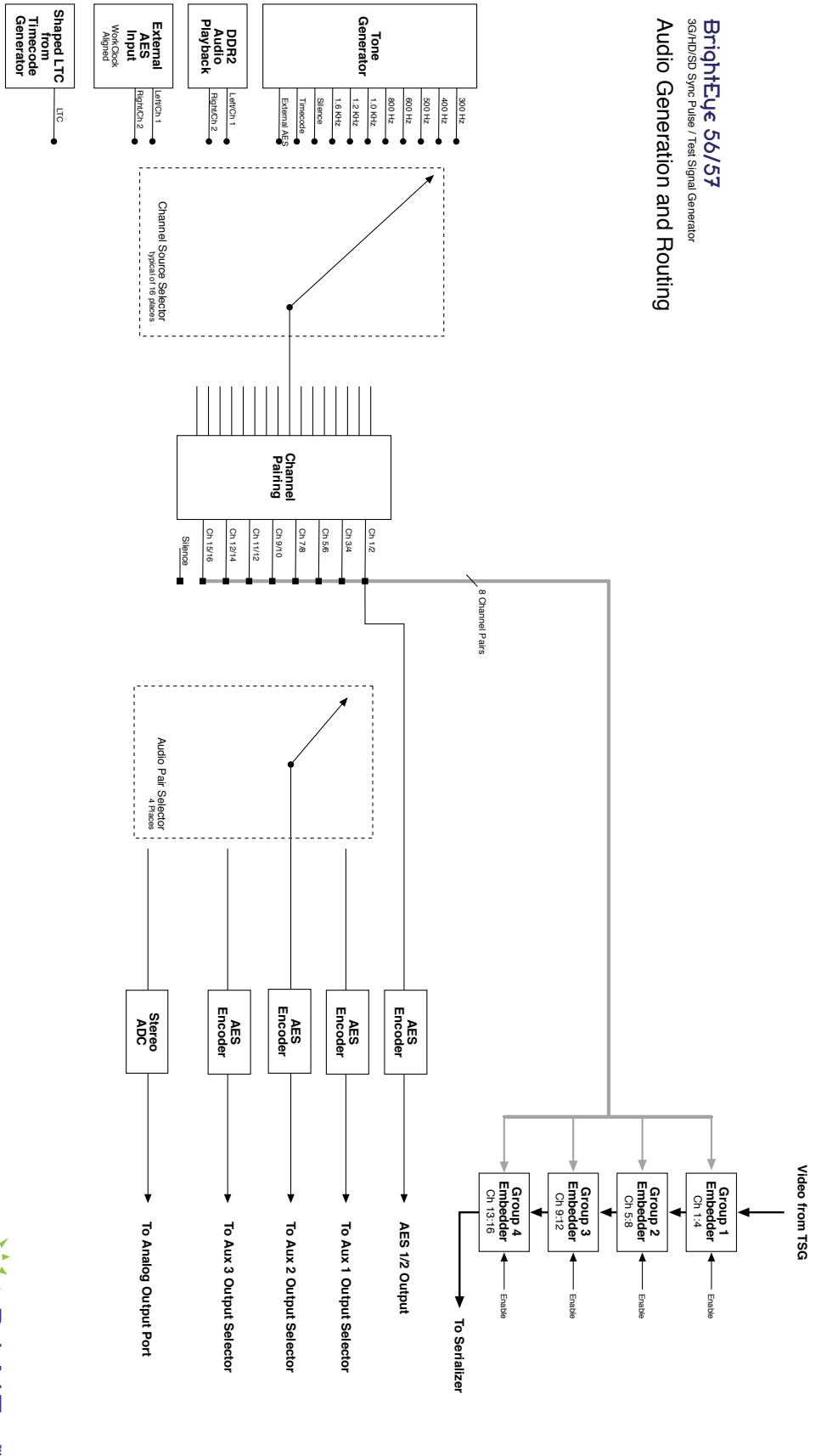

BrightEye 57 Audio Generation and Routing Functional Diagram, Landscape View



Applications

BrightEye 57's complete feature set makes it a versatile genlock sync and test signal generator. Its small size also makes it an excellent choice for use in mobile applications. Two examples of BrightEye 57 applications are given below.

Analog, HD SDI and Audio Reference Outputs

In the example below, the BrightEye 57 is providing analog, HD SDI and audio reference outputs. A BrightEye 41 distributes copies of the composite signal output. BrightEye 57 can provide all the reference signals needed for post, mobile or broadcast application.

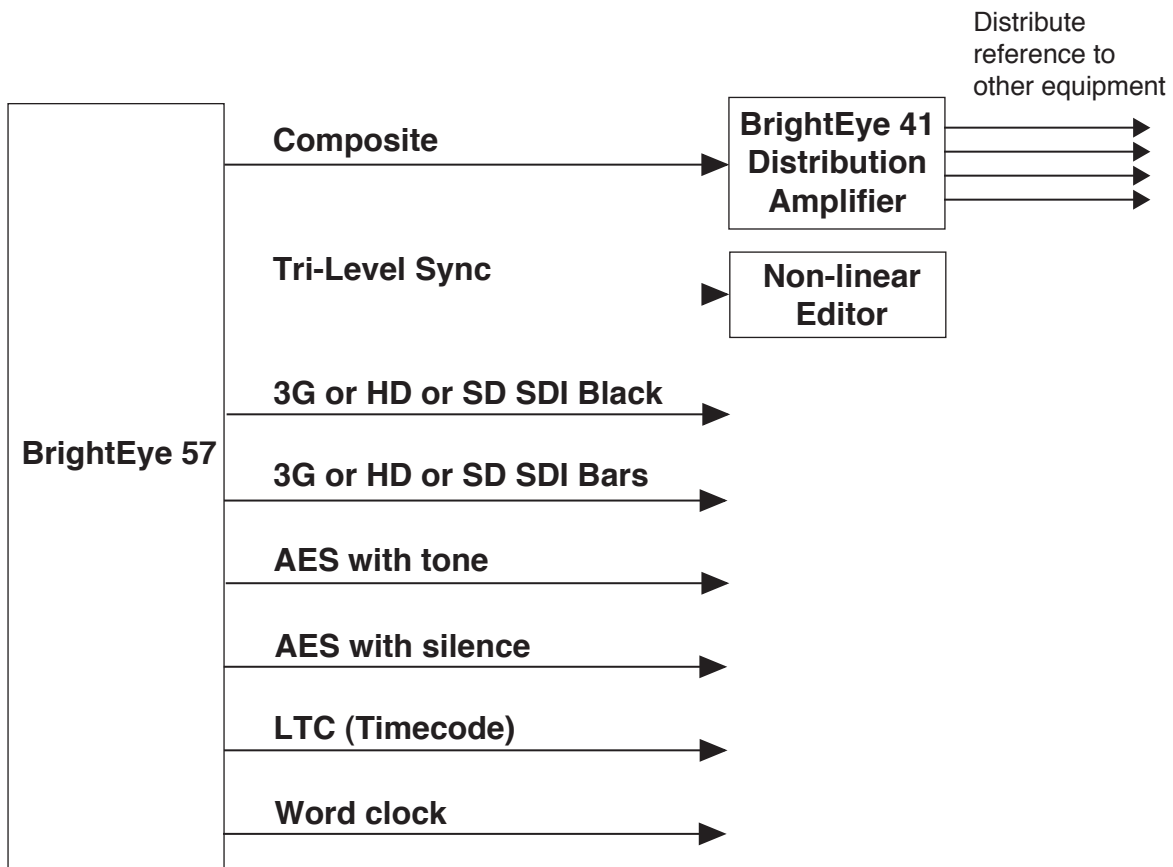

BrightEye 57 providing analog, HD SDI and audio reference outputs

Genlocked Test Signals

BrightEye 57 can be used to provide bars and other test signals to facility devices timed to the same house reference. A number of test signals can be fed to a router, switcher, and other devices in a facility where genlocked timing is important.

As shown in the example below, a BrightEye 57 is fed with the house reference to the Ref In BNC. The audio tone can be embedded into the SDI timed test signal output and fed to an HD or SD SDI router and switcher. This allows each of the test signals to be in time with the signals fed to the other devices.

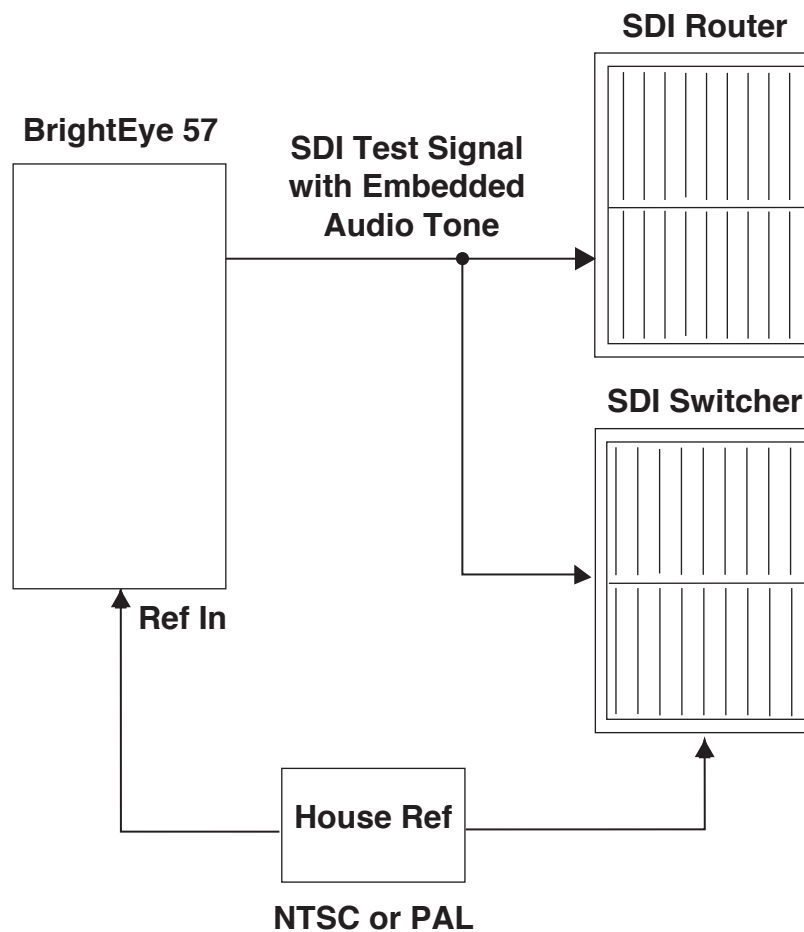

BrightEye 57 Genlocked Test Signal Application

Rear Connectors

All connections to the BrightEye 57 are made on the rear of the unit. Refer to the illustration below.

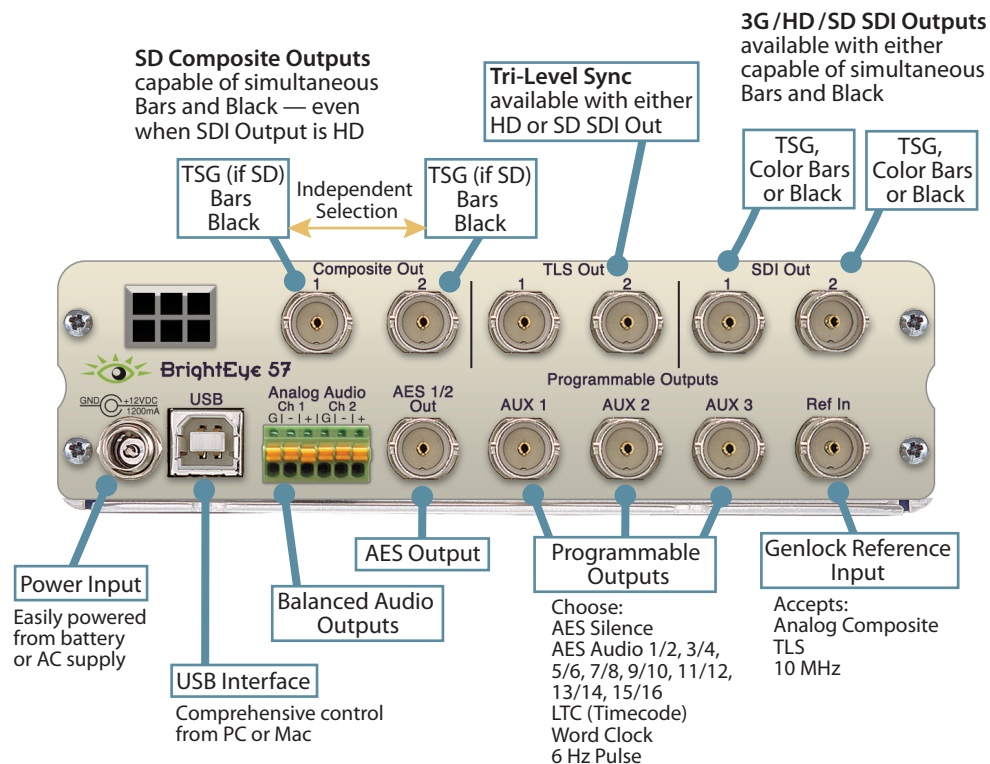

Power Connection

Connect a modular power supply to the 12 volt DC power input connection on the far left of the unit. Use the locking ring to secure it. Make sure you are using a power supply that provides at least 12V at 1.5A.

USB Connector

The USB connector is used to provide more comprehensive control, diagnostics, and upgrades to the unit from a PC or Mac. Use the BrightEye Control application (version 2.1.2 or later) included on CD-ROM to make adjustments as described in the Operation section of this user guide.

Audio Out

The Audio Out provides two channels of an analog audio reference tone. Wiring is done by inserting a 6 pin connector provided with the unit. Analog reference levels can be configured from the BrightEye Control application.

To connect audio to this connector type, strip the audio wire to about 3/8" (8 mm). Solder tinning is not required. Push the wire into the opening at the bottom of the connector to seat the connection. This will snap the wire into place.

To remove the wire, push in the pin above the connection with a small pointed tool. This will release the wire from the connector.

Balanced Analog Audio Connection

To connect the audio output to an audio XLR connector, connect the pins as follows:

- Attach Ground from Pin 1 of the Audio Out to Pin 1 of the XLR.
- Attach the + (plus) signal from Pin 2 of the Audio Out to Pin 2 of the XLR.
- Attach the – (minus) signal from Pin 3 of the Audio Out to Pin 3 of the XLR.

For Unbalanced Audio to a RCA Phono Input

To connect the audio output to a consumer audio connector such as an RCA phono jack, connect the pins as follows:

- Attach Ground from Pin 1 of the Audio Out to the shell, Shield or Ground of the RCA Phono jack.
- Attach the + (plus) signal from Pin 2 of the Audio Out to the center pin of the RCA Phono jack.
- The – (minus) signal is not used in this application.

AES 1/2 Out

The AES 1/2 Out is a BNC connector that provides a digital audio output in the AES format. The AES Output can be configured from the front panel and from the BrightEye Control application.

TLS Out

The Tri Level Sync Out is an output BNC connector that supplies Tri Level Sync in a number of user-selected formats. Use either the front panel or the BrightEye Control application to select the desired format.

SDI Out

The SDI Out is a BNC connector that provides test patterns or black in serial digital component format. Test patterns and video standard can be selected from the front panel as well as from the BrightEye Control application. The AES audio test signals can be embedded in this signal using the BrightEye Control application. The SDI Out can deliver 270 Mb/s SD Serial Digital, 1.485 Gb/s HD Serial Digital, and 2.97 Gb/s HD Serial Digital.

SD Composite Out

The SD Composite Out 1 and 2 are BNC connectors that present either an NTSC or PAL composite output. These outputs provide the same test patterns as SDI Out, only in composite format. The test patterns can be selected from the front panel and from the BrightEye Control application.

Ref In (Reference In)

The Ref In BNC accepts 1 V P-P PAL, NTSC, 10 MHz or Tri Level Sync reference input to provide an overall genlock timing reference for the unit.

Programmable Outputs

The Programmable Outputs (Aux 1, Aux 2 and Aux 3) BNCs are programmable outputs that can deliver LTC (Timecode), AES Audio 1/2, 3/4, 5/6, 7/8, 9/10, 11/12, 13/14, 15/16, AES Silence, Word Clock or 6 Hz Pulse.

Module Configuration and Control

Control and operation of the BrightEye 57 is performed from the front panel and with the BrightEye Control application (version 2.1.2 or later). Some control settings and parameter choices are available only with BrightEye PC or Mac. These parameters cannot be monitored from the front panel.

Front Panel Controls and Indicators

The front panel shown in the figure below provides status indicators and control over video and audio output.

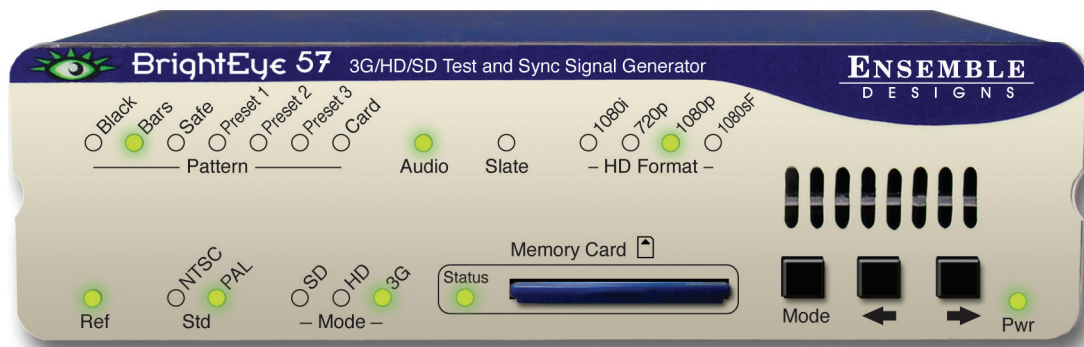

Status Indicators

The following status indicators are provided on the front panel:

Pattern

The currently selected video pattern will illuminate green. Choices include:

Black (choices include Black, Flat Field 20, Flat Field 80), Bars (choices include 75% Full Bars, 100% Full Bars, 75% Split Bars, 100% Split Bars, SMPTE Bars, SMPTE 219 Bars), Safe (Safe Title), Crosshatch, Preset 1, Preset 2, Preset 3, or User Card.

“Preset” refers to menu selections available in the Pattern menu in the BrightEye Control application. Each of the Preset fields (Preset 1, Preset 2, Preset 3) have fifteen pattern types available to select in the Pattern menu.

“Card” refers to a test pattern stored on a Secure Digital Memory Card. If the Card green light is illuminated, it indicates that you have inserted an SD Memory Card into the card slot in the front of the BrightEye 57 and selected “User Card” from the Pattern Sel field in the Pattern menu.

Audio

Illuminates green when the option is selected to embed Audio.

Slate

Illuminates green when the signal identification slate is enabled. To change the Slate Text ID, use the ID, ID Mode, and Slate Text fields in the Pattern menu in the BrightEye Control application.

HD Format

The currently selected HD Format (1080i, 720p, 1080p, or 1080sF) is illuminated green. The Tri Level Sync (TLS) frame rate is determined by the selections made in the Standard, Mode and HD Format fields in the Format menu of the BrightEye Control application.

Ref (Reference)

The status indicator will be green when a valid reference is present and locked.

Std (Standard)

The currently selected output standard (NTSC or PAL) illuminates green.

Mode

The currently selected mode (SD, HD, 3G) Illuminates green.

Memory Card Status

Illuminates green when a Secure Digital (SD) flash memory card is correctly inserted into the SD card slot.

Pwr (Power)

Illuminates green when the BrightEye unit has power and the internal voltage regulator is functioning correctly.

Adjusting Parameters from the Front Panel

Use the **Mode**, **Right Arrow**, and **Left Arrow** buttons to select and adjust parameters from the front panel.

Pressing the **Mode** button activates the front panel for editing and tabs between each section of editable parameters.

Pressing the **Right Arrow** or **Left Arrow** advances the selection within a given section of parameters, or increases (**Right Arrow**) or decreases (**Left Arrow**) the value of a selected parameter.

Note: The LED of an edited parameter will blink for 15 seconds, after which time its value is stored in memory. If power is interrupted before this 15 second timeout period has elapsed, the edited state will not be saved.

Using the BrightEye Control Application

The BrightEye PC and BrightEye Mac applications (version 2.1.2 or later) included on CD-ROM are designed to allow you to configure and control the BrightEye 57 from a personal computer. Instructions for installing and using this software application are given in the PDF manual on the CD-ROM.

If the BrightEye 57 is connected to a computer running this software, the menus discussed on the following pages are available for controlling and monitoring the unit.

Format Menu

To select the output format of the **Test Signal and Sync Pulse Generator**, select the **Format** menu shown below. Use the drop-down menus to set the parameters for the **Standard**, **Mode**, and **HD Format** fields.

- **Standard** – select the output standard you want to use. Choices are: NTSC, PAL
- **Mode** – select the mode you want to use. Choices are: SD, HD, 3G
- **HD Format** – select the HD Format. Choices are: 1080i, 720p, 1080p, 1080sF
- **1080p Frame Rate** – select the 1080p Frame Rate. Choices are: 1080p - 23/24 fps, 1080p - 29/30 fps. Applicable only when 1080p is selected from the **HD Format** control.

The remaining fields, **SDI Format**, **Cpst Format**, and **TLS Format**, are status indicators. They are not editable. They reflect the format selections made in the **Standard**, **Mode** and **HD Format** menus.

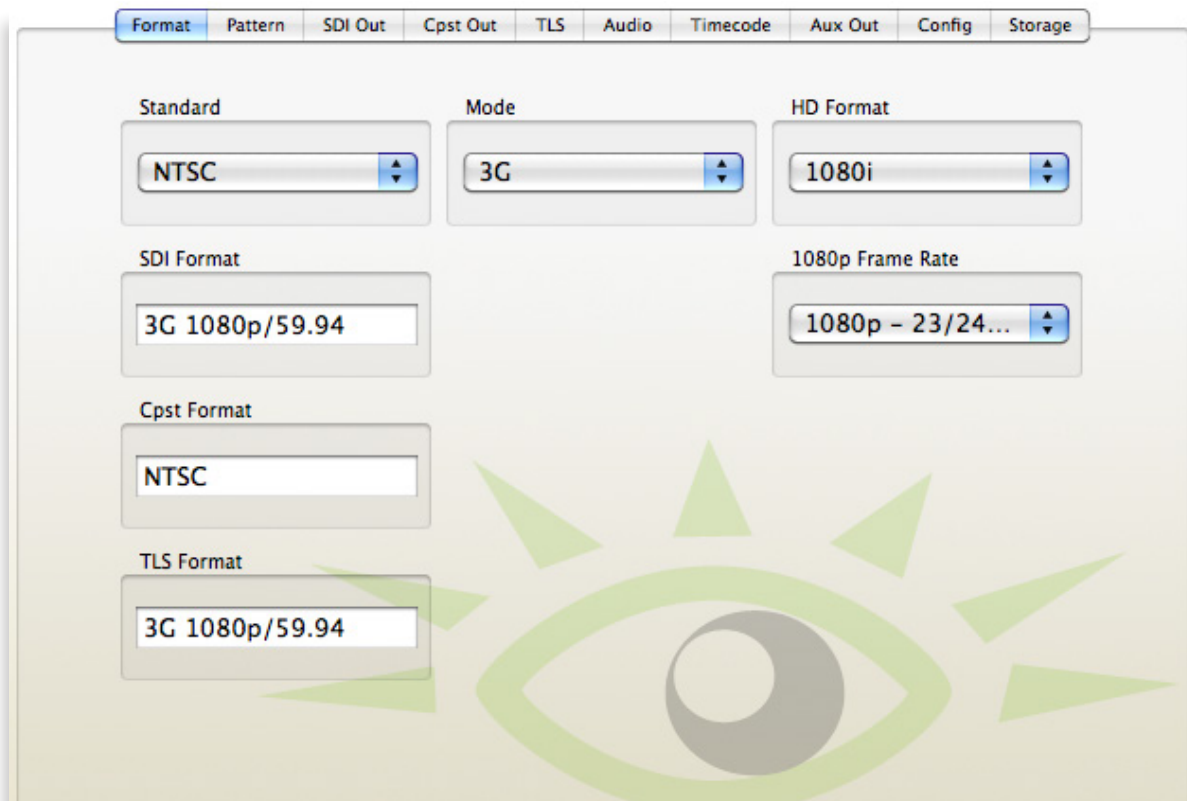

Pattern Menu

To select the video test pattern, select the **Pattern** menu shown below. Use the drop-down menus to set the parameters for the **Pattern Sel**, **Preset 1**, **Preset 2**, and **Preset 3** fields. Or select a test pattern stored on a Secure Digital Memory Card. Enable or disable the Y, Cr and Cb Channels. Determine the Slate ID parameters.

- **Pattern Sel** – select the video test pattern for output from the drop-down menu. Choices are: Black, Flat Field 20, Flat Field 80, 75% Full Bars, 100% Full Bars, 75% Split Bars, 100% Split Bars, SMPTE Bars, SMPTE 219 Bars, Safe Title, Crosshatch, Preset 1, Preset 2, Preset 3, User Card.
- **Preset 1, Preset 2, Preset 3** – select the video test pattern for the Preset fields. To use one of the Preset test patterns, select from each Preset drop-down menu: Flat Field 50, White, Red Field Bars, Video Ramp, Data Ramp, Shallow Ramp, 5 Step, Sweep, MultiBurst, Full Field Window, Component Window, Digital Blanking, Cosite, Interlace, Pathological.
- **User Ptn Sel** – use the up and down arrows on this control to select a custom video test pattern stored on the Secure Digital Memory Card. Each number corresponds to one of the video test patterns on the card.

Please see the [BrightEye Support page](#) for a link to download the Test Pattern Generator software application. See also the [Pattern Generator User Guide](#) for details on preparing test patterns for use with the BrightEye 57.

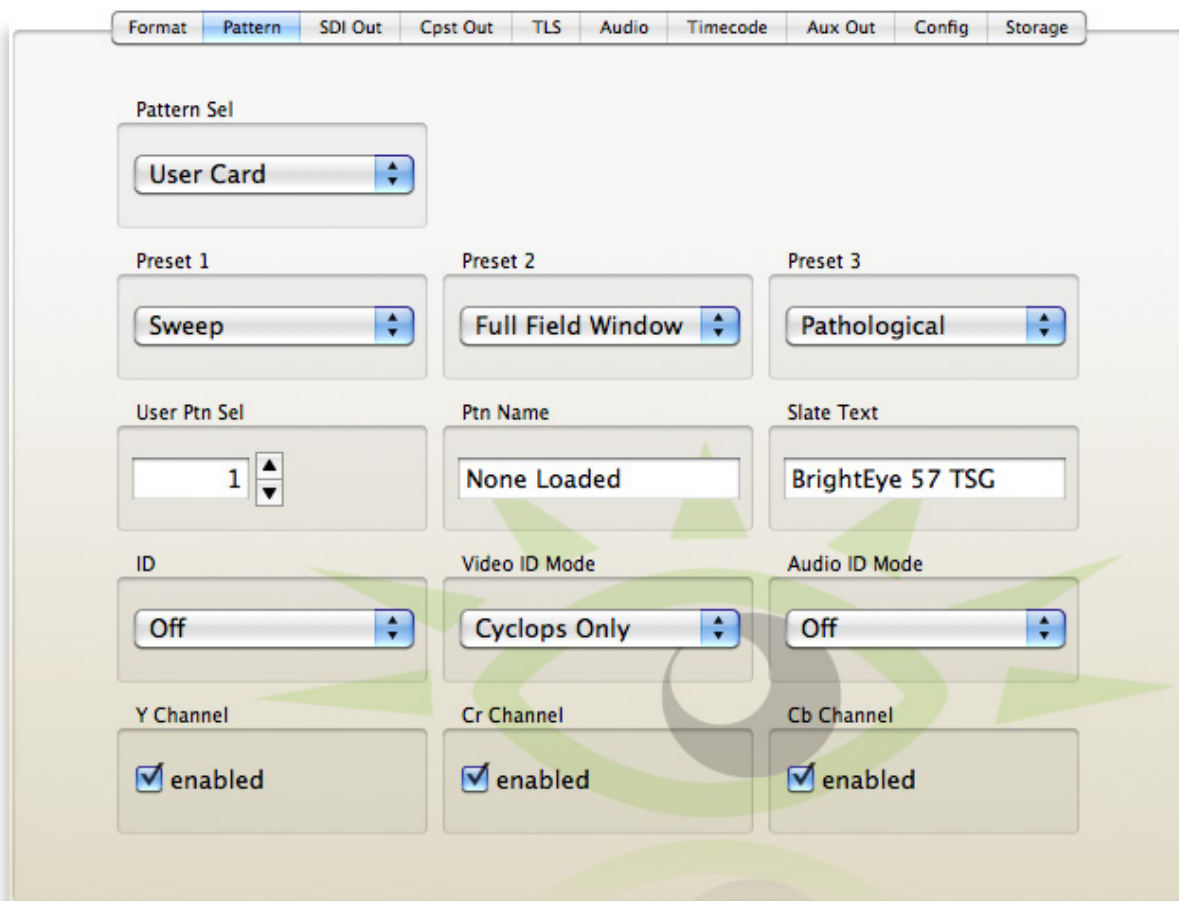

The screenshot displays the 'Pattern' menu interface. At the top, there is a navigation bar with tabs for 'Format', 'Pattern', 'SDI Out', 'Cpst Out', 'TLS', 'Audio', 'Timecode', 'Aux Out', 'Config', and 'Storage'. The 'Pattern' tab is selected. Below the navigation bar, the interface is organized into several sections:

- Pattern Sel:** A drop-down menu currently showing 'User Card'.
- Preset 1:** A drop-down menu showing 'Sweep'.
- Preset 2:** A drop-down menu showing 'Full Field Window'.
- Preset 3:** A drop-down menu showing 'Pathological'.
- User Ptn Sel:** A numeric input field with up and down arrows, currently set to '1'.
- Ptn Name:** A text input field showing 'None Loaded'.
- Slate Text:** A text input field showing 'BrightEye 57 TSG'.
- ID:** A drop-down menu showing 'Off'.
- Video ID Mode:** A drop-down menu showing 'Cyclops Only'.
- Audio ID Mode:** A drop-down menu showing 'Off'.
- Y Channel:** A checkbox labeled 'enabled' which is checked.
- Cr Channel:** A checkbox labeled 'enabled' which is checked.
- Cb Channel:** A checkbox labeled 'enabled' which is checked.

- **Ptn Name** – when there is an SD Memory Card loaded, the **Ptn Name** field displays the name of the custom video test pattern selected from the **User Ptn Sel** field. When there is no Secure Digital Memory Card loaded, the **Ptn Name** field displays “None Loaded.”
- **Slate Text** – enter the Slate Text ID to be displayed on screen. This is useful for identifying a location or destination; for example, Truck 1, News 2, Studio A, Helicopter 4, etc.
- **ID** – On or Off. When On, it means that the Slate Text ID displays on screen over the top of the selected video test pattern. When Off, the Slate Text ID will not display.

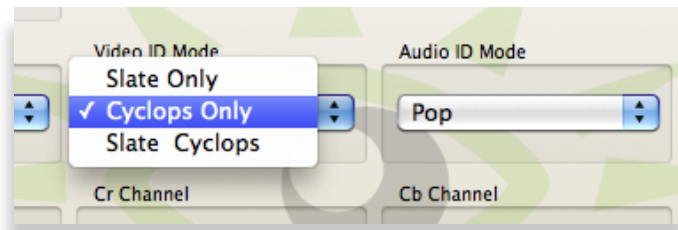

- **Video ID Mode** – select one of three modes: Slate Only, Cyclops Only, or Slate Cyclops. Slate Only means that only the Slate Text ID will display over the selected video test pattern. Cyclops Only means that Cyclops will display over the selected video test pattern. (Cyclops adds a moving element to the test signal in order to assist in checking that a particular signal path is live.) Slate Cyclops means that both the Slate Text ID and Cyclops will display on screen over the top of the selected video test pattern.

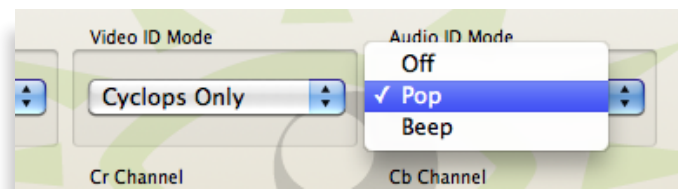

- **Audio ID Mode** – select Off, Pop or Beep. The left/right Pop and Beep synchronizes to the Cyclops feature and assists with left/right audio channel identification. Please note that audio embedding must be enabled from the Audio menu in order for the Pop or Beep to be present in the test signal.
- **Y Channel, Cr Channel, Cb Channel** – use each of the three check box fields to enable or disable each channel independently. This is useful for setting up monitors or troubleshooting.

SDI Out Menu

From the SDI Out menu, you can select a value for the SDI video outputs (SDI Out 1 and SDI Out 2). Vertical and Horizontal Timing adjustments are provided for timing the outputs with respect to the reference input.

- **SDI Format** – reports which 3G, HD or SD format has been selected for the SDI Output BNCs. To change the format, use the **Format** menu described earlier.
- **SDI 1 OutSel** – select from these values: TSG, Black, or Color Bars for the SDI BNC video outputs.
- **SDI 2 OutSel** – select from these values: TSG, Black, or Color Bars for the SDI BNC video outputs.
- **Vert Timing** – Set the vertical timing in lines. Range is -1000 to 1000 lines, default is zero. Use the slider controls or arrows to select a value or enter a value directly into the number field.
- **Hor Timing** – Set the horizontal timing in clocks. Range is -2000 to 2000 clocks, default is zero. Use the slider controls or arrows to select a value or enter a value directly into the number field.

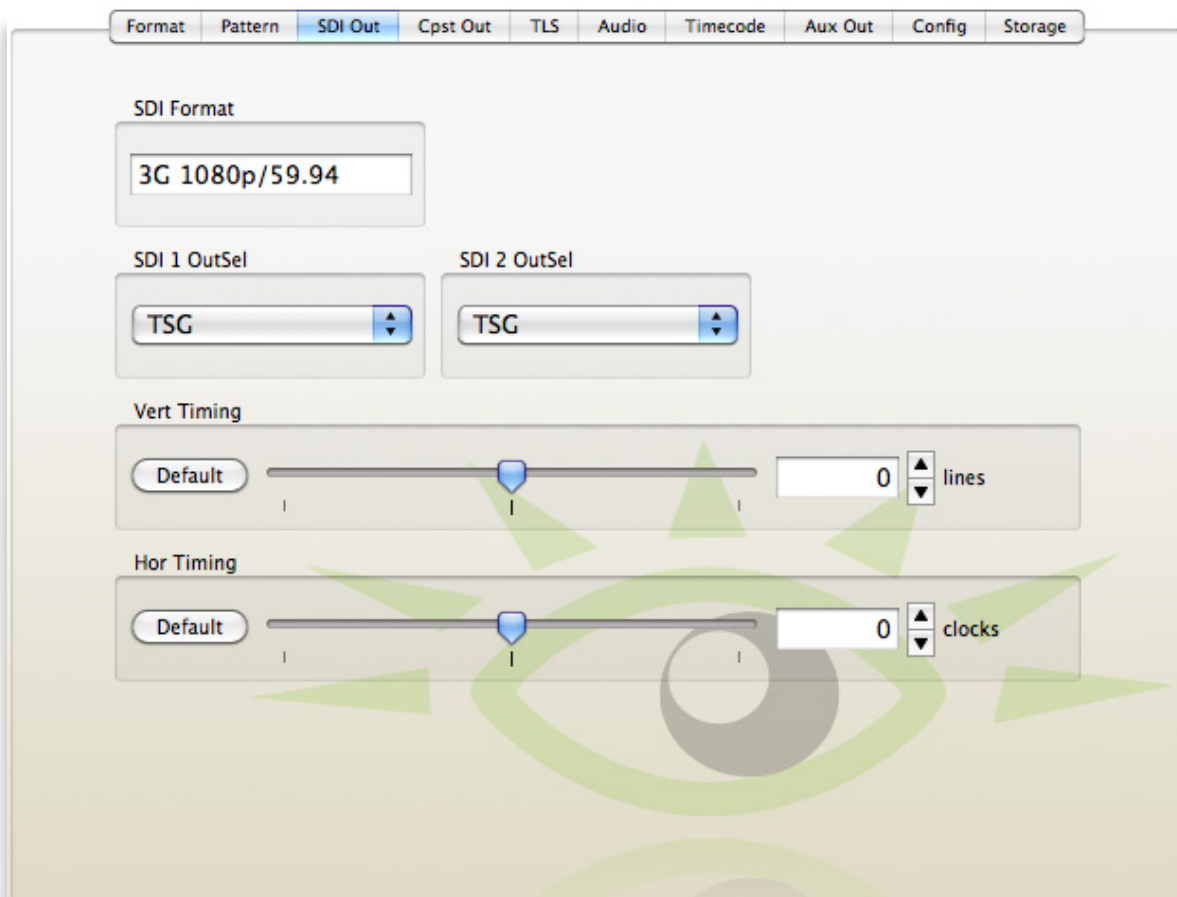

Cpst Out Menu

From the Cpst Out menu, you can select a value for the Cpst video outputs (Composite Out 1 and Composite Out 2). Vertical Timing, Horizontal Timing and Fine Phase adjustments are provided for timing the outputs with respect to the reference input.

- **Cpst Format** – reports what format has been selected for the Composite BNC Output. To change the format, use the **Format** menu described earlier.
- **Cpst 1 OutSel** – select from these values: Black, Color Bars, or Follow SDI Out.
- **Cpst 2 OutSel** – select from these values: Black, Color Bars, or Follow SDI Out.
- **Vert Timing** – Set the vertical timing in lines. Range is -525 to 525 lines, default is zero. Use the slider controls or arrows to select a value or enter a value directly into the number field.
- **Hor Timing** – Set the horizontal timing in clocks. Range is -1716 to 1716 clocks, default is zero. Use the slider controls or arrows to select a value or enter a value directly into the number field.
- **Fine Phase** – Set the fine phase in nanoseconds (nsec). Range is -35 to 35 nsec, default is zero. Use the slider controls or arrows to select a value or enter a value directly into the number field.

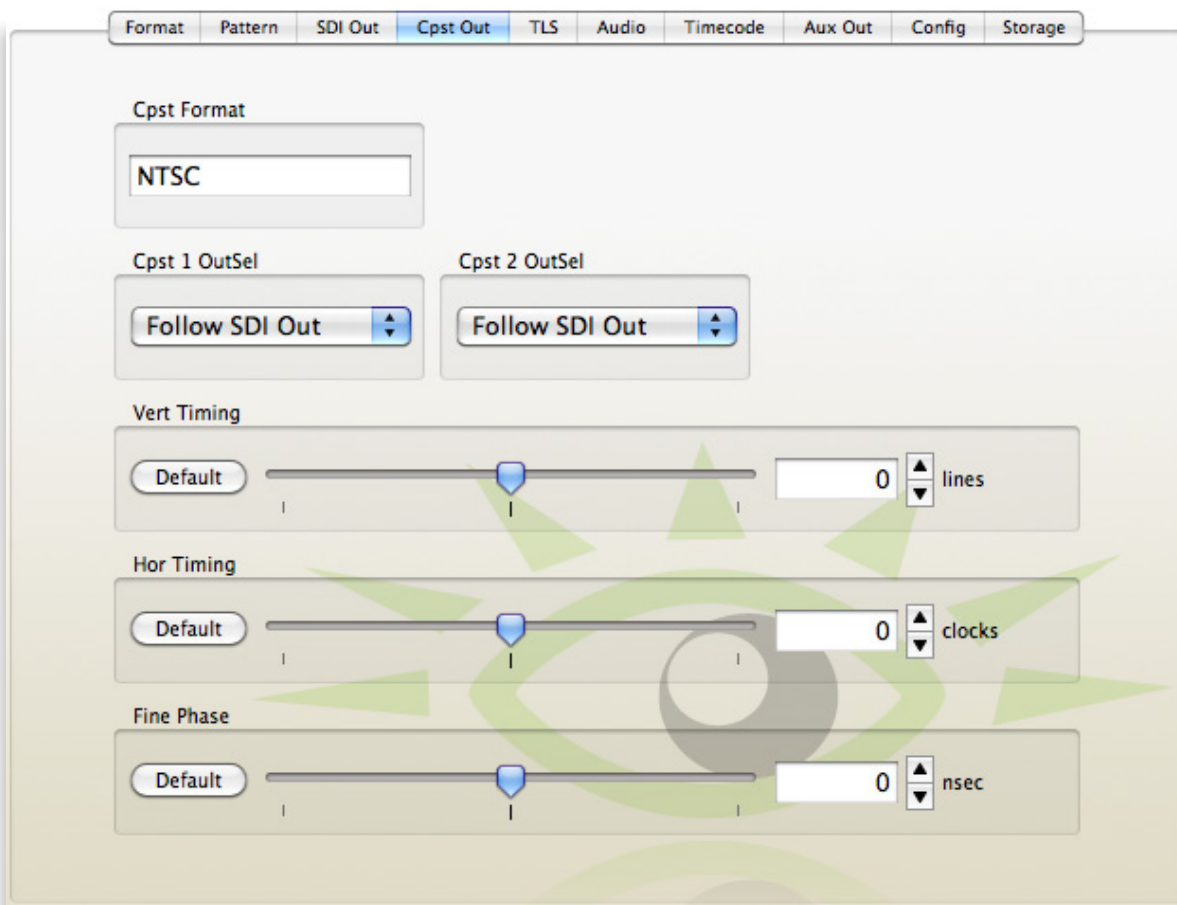

TLS Menu

From the TLS menu, you can adjust the Vertical and Horizontal Timing of the Tri Level Sync with respect to the reference input.

- **TLS Format** – Mirrors the TLS Format field in the **Format** menu. Reports the TLS format that has been selected from the **Format** menu described earlier.
- **Vert Timing** – Set the vertical timing in lines. Range is -1000 to 1000 lines, default is zero. Use the slider controls or arrows to select a value or enter a value directly into the number field.
- **Hor Timing** – Set the horizontal timing in clocks. Range is -2000 to 2000 clocks, default is zero. Use the slider controls or arrows to select a value or enter a value directly into the number field.

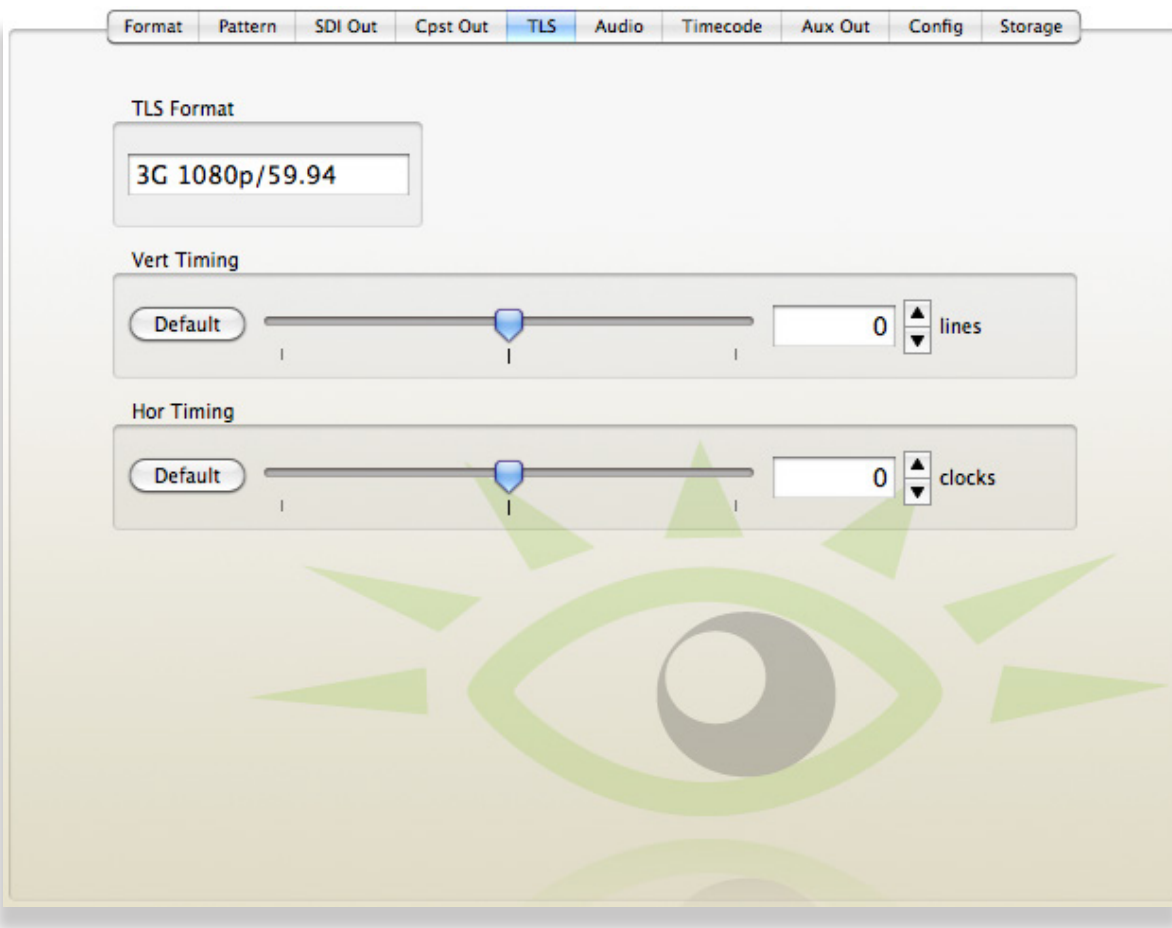

Audio Menu

The BrightEye 57's tone generator supports sixteen audio channels. The content of each channel is independently programmable. Choices include adjustable frequency tone generators, tone sweeps, silence, timecode, and audio clip playback from the SD (secure digital) Memory Card. All sixteen of these channels can be embedded in the SDI outputs. Each AES output can select from any of the eight pairs that make up these sixteen channels.

This menu affects the **SDI Out** and **AES 1/2 Out** BNCs.

There are three types of audio output: Embedded, AES (goes to **AES 1/2 Out**) and Analog (output goes to the Analog Audio output).

The **Audio** menu shown below allows you to select a **Channel Number** and **Audio Source**, to make Embedded Audio selections, and to choose the channel for **Analog Out**.

Use the controls to set the following:

- **Chan Number** – Select a channel, 1 through 16, and then use the Audio Source control to select the desired contents for that channel.
- **Audio Source** – Available selections are:
 - 300 Hz Tone
 - 400 Hz Tone
 - 500 Hz Tone
 - 600 Hz Tone
 - 800 Hz Tone
 - 1.0 kHz Tone
 - 1.2 kHz Tone
 - 1.6 kHz Tone
 - Silence
 - Timecode
 - External AES
 - TSG Audio
- **Embed Grp 1 through 4** – Use the checkbox controls to enable or disable each group.
 - Group 1 includes channels 1/2 and 3/4.
 - Group 2 includes channels 5/6 and 7/8.
 - Group 3 includes channels 9/10 and 11/12.
 - Group 4 includes channels 13/14 and 15/16.

- **Embedding** – Turn embedding on or off. When checked, embedding is on and the green Audio light is illuminated on the BrightEye 57 front panel. When not checked, embedding is off and the green Audio light on the front panel is not illuminated.
- **Analog Out** – Available selections are:
 - Channels 1/2
 - Channels 3/4
 - Channels 5/6
 - Channels 7/8
 - Channels 9/10
 - Channels 11/12
 - Channels 13/14
 - Channels 15/16

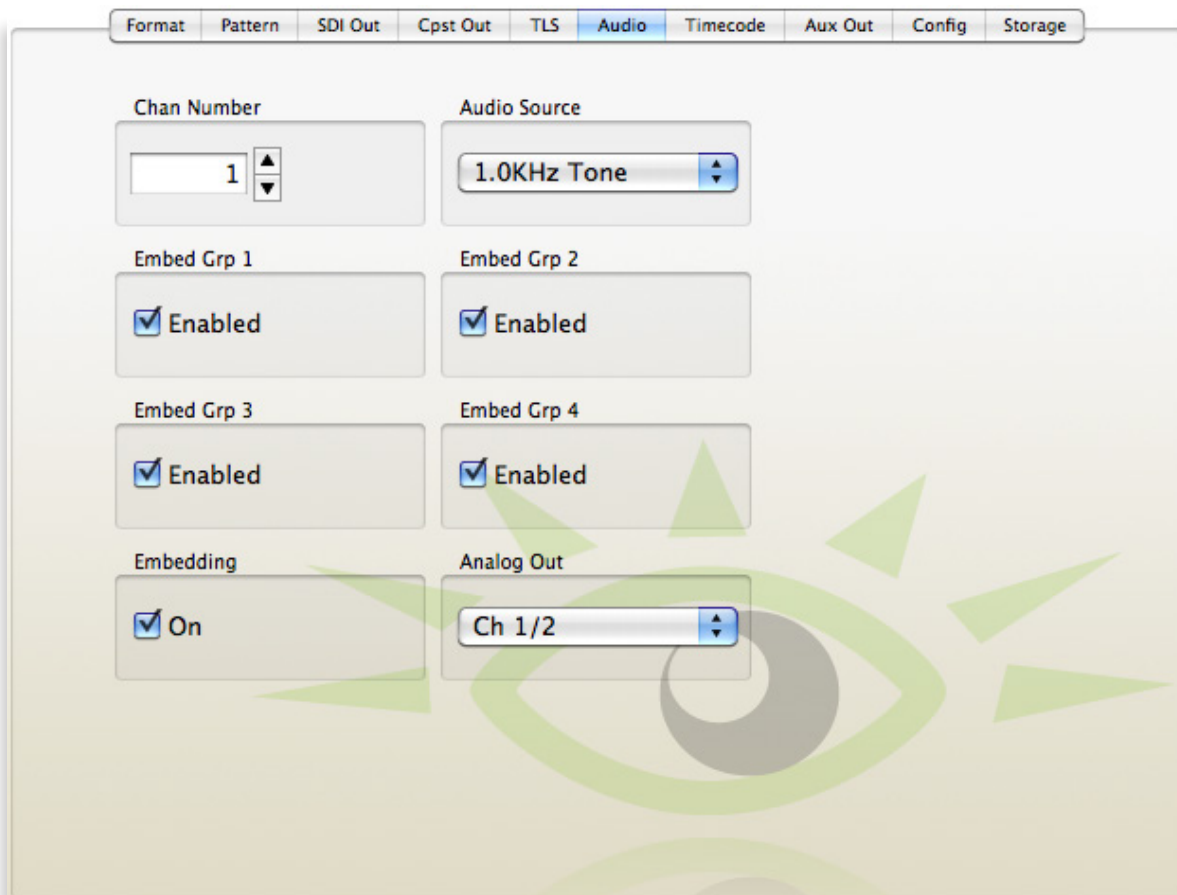

Timecode Menu

You can load the Timecode Generator with a preset value through the control system. When a BrightEye 57 powers up, the Timecode Generator starts at 0:0:0. Alternatively, the BrightEye 57 can read VITC present on the reference input. This timecode value will be used continuously by the BrightEye 57's internal generator. When this option is selected, the timecode presented on the many different outputs will all match the timecode on the reference input.

The **Timecode** menu shown below allows you to set the following parameters:

- **Hours** – 0 through 23
- **Minutes** – 0 through 59
- **Seconds** – 0 through 59
- **TCG Mode** – select from these values: Run, Track Ref, Jam!, Hold.
- **Drop Frame** – Select the checkbox to enable Drop Frame (dropping two frames every minute except on every tenth minute) to allow timecode to match a real-time clock.
- **Cpst VITC** – Vertical interval timecode (VITC) can be routed to an analog composite output. Select which lines you want to route to from these menu values: Lines 13, 15; Lines 14, 16; Lines 15, 17; Lines 16, 18; Lines 17, 19; Lines 18, 20; Lines 19, 21, or select Off to disable.
- **SDI DVITC** – Digital vertical interval timecode (DVITC) can be routed to an SD SDI output. Select which lines you want to route to from these menu values: Lines 13, 15; Lines 14, 16; Lines 15, 17; Lines 16, 18; Lines 17, 19; Lines 18, 20; Lines 19, 21, or select Off to disable.

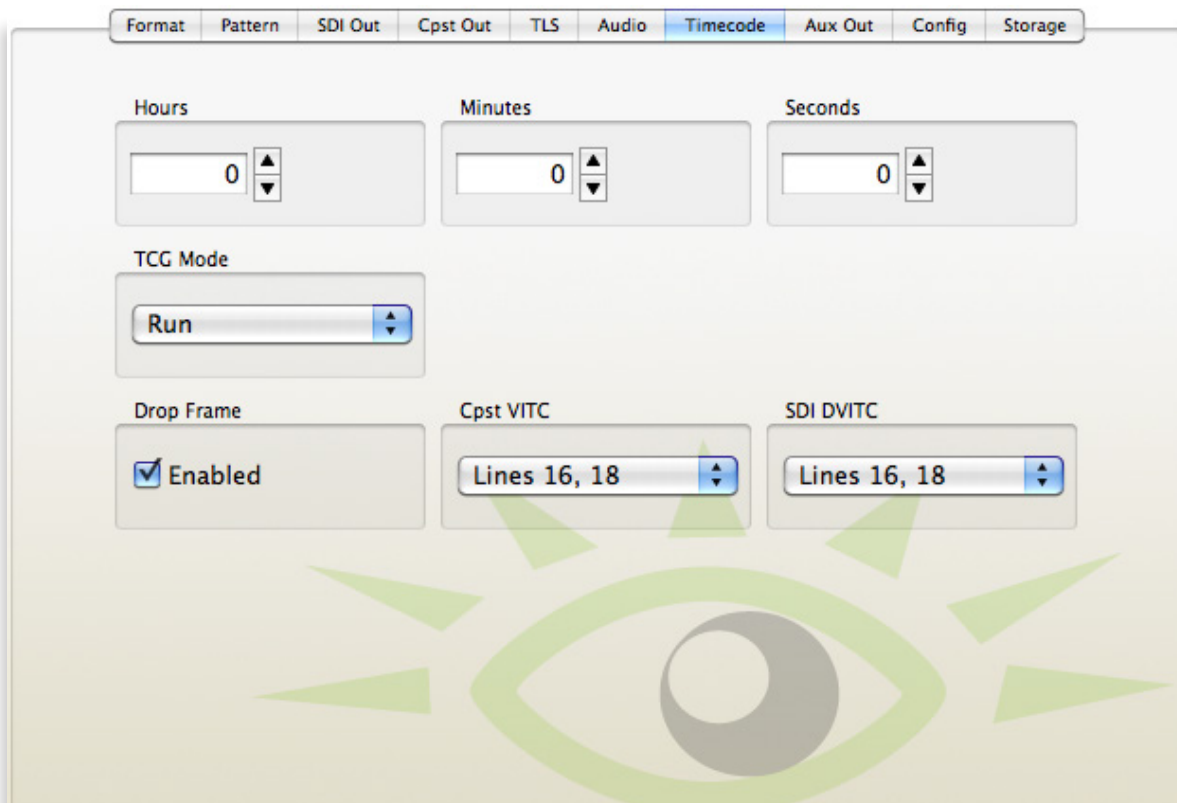

Aux Out Menu

The **Aux Out** menu shown below allows you to set the output standards for the Programmable Output BNCs **Aux 1**, **Aux 2** and **Aux 3**.

The available selections are identical for all three controls. Choose from the following values:

- LTC Timecode
- AES Audio 1/2
- AES Audio 3/4
- AES Audio 5/6
- AES Audio 7/8
- AES Audio 9/10
- AES Audio 11/12
- AES Audio 13/14
- AES Audio 15/16
- AES Silence
- Word Clock
- 6 Hz Pulse

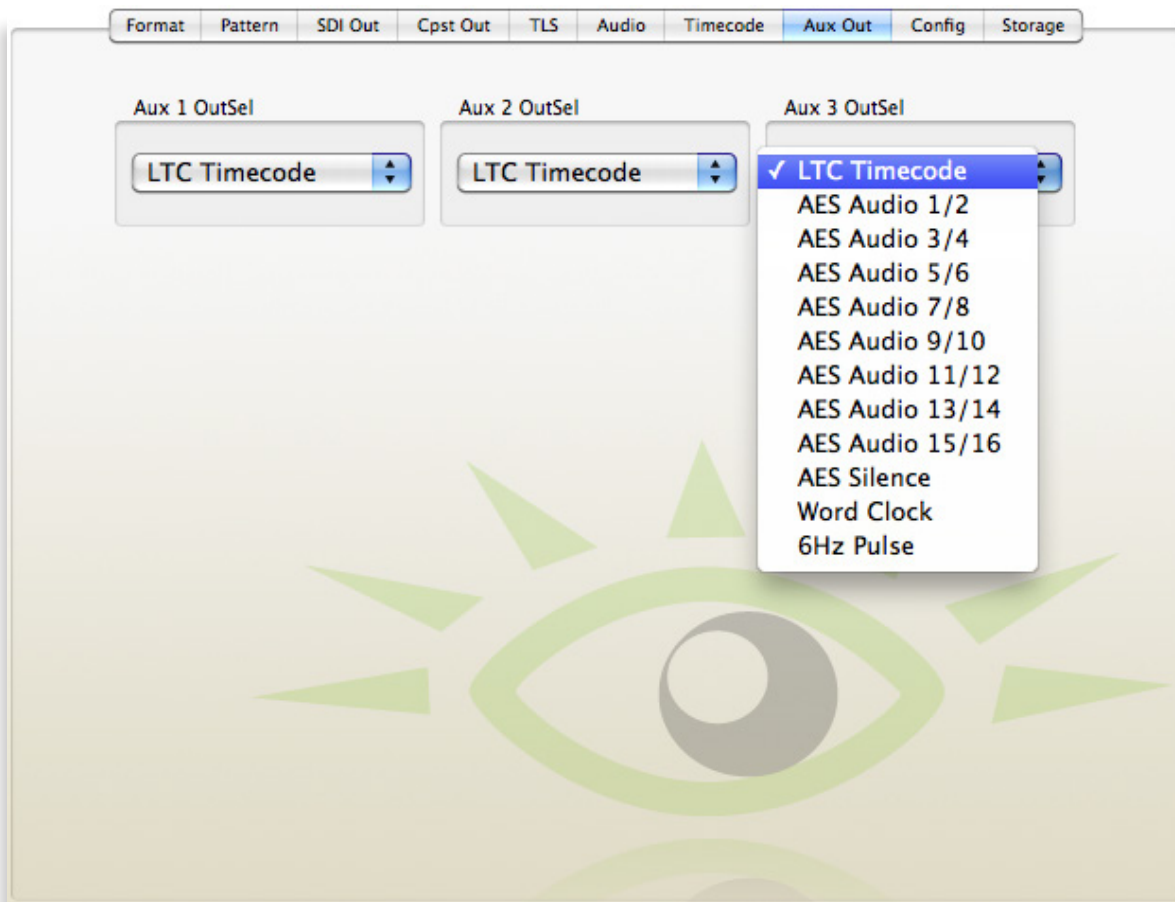

Config Menu

The BrightEye 57 can lock to an external house reference or it can lock to its own internal precision standard reference. From the **Config Menu**, you can select the overall genlock timing reference, enable or disable Composite Setup, and select levels for Digital and Analog Audio Reference Levels.

Use the controls to set the following:

- **Ref Mode** – Affects which source the BrightEye 57 uses for the overall genlock timing reference. Select **Internal** to lock to the internal precision standard or **Genlock** to lock to the input reference signal. If **Genlock** is selected but no reference signal is connected, BrightEye 57 will free run. When **Internal** is selected, the internal precision standard runs at a 10 MHz accuracy.
- **Reference** – Reports if a reference signal is connected to the **Ref In BNC**.
- **Sync Lock** – Reports the standard the module is locked to. If the module is not locked to a standard, it displays No Lock.
- **Cpst Setup** – Select the Enabled checkbox to enable Composite Setup. Composite Setup is typically enabled.
- **Dig Ref Level** – Select the digital audio reference level. Choices are -20 dBFS and -18 dBFS.
- **Anlg Ref Level** – Select the analog audio reference level. Choices are -10 dB, -6 dB, -4 dB, 0 dB, +4 dB.
- **Ref VITC Line** – Use this control to select the line on which VITC is present. Available choices are Line 12, Line 13, Line 14, Line 15, Line 16, Line 17, Line 18, Line 19, Line 20, Line 21.

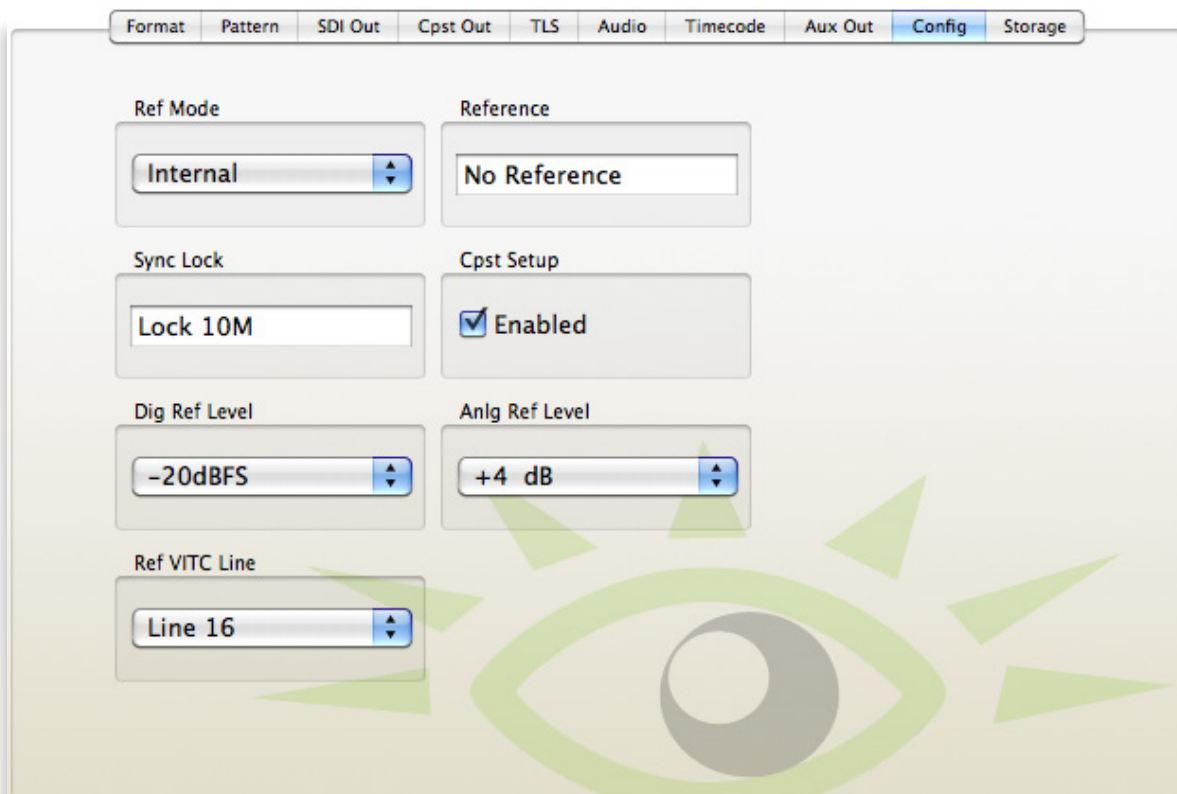

Storage Menu

With the **Storage** menu shown below, you can monitor the status of an SD card and view the amount of available RAM.

- **SD Card Status** – Reflects the status of the Secure Digital Card.
- **RAM Module** – Shows the RAM capacity of the BrightEye 57's generator.

Please see the [BrightEye Support page](#) for a link to download the Test Pattern Generator software application. See also the [Pattern Generator User Guide](#) for details on preparing test patterns for use with the BrightEye 57.

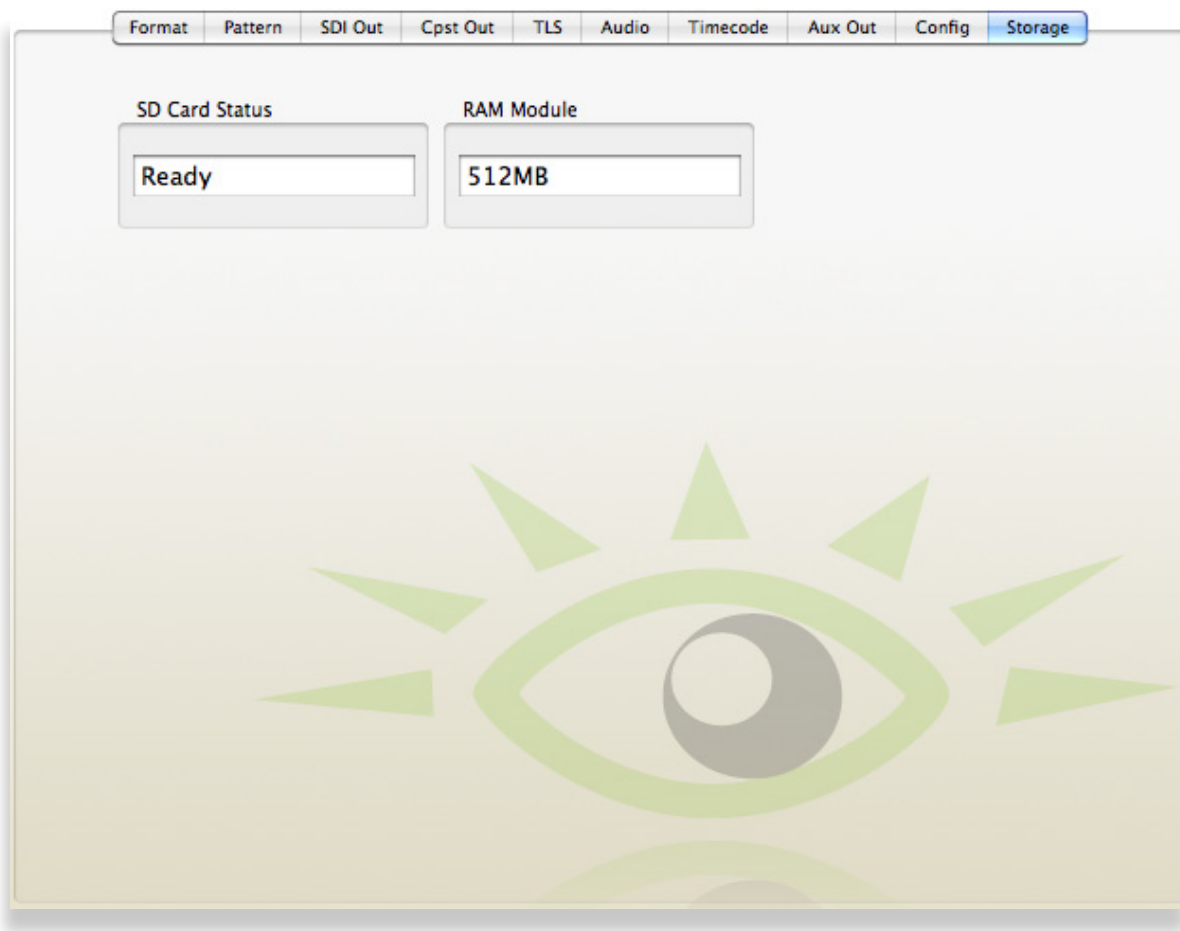

Troubleshooting

As a troubleshooting aid, the reference signal status and presence, power and CPU status can be easily monitored from the front panel using the front panel indicators.

Refer to the overall troubleshooting tips given below for the BrightEye 57.

No signal output

- Check that the expected signal output matches the output selected in the **Format Menu**.
- Check the configuration of Ref Mode in the **Config Menu**. Make sure that the appropriate setting (Internal or Genlock) is selected for the expected signal output.

You may also refer to the technical support section of the Ensemble Designs web site for the latest information on your equipment at the URL below:

<http://www.ensembledesigns.com/support>

Software Updating

Software upgrades for BrightEyes are available at:

<http://www.ensembledesigns.com/support/brighteye-support/>

Use BrightEye Mac or PC software (version 2.1.2 or later) to install the software update into your BrightEye.

Warranty and Factory Service

Warranty

This unit is covered by a five-year limited warranty. If you require service (under warranty or not), please contact Ensemble Designs and ask for customer service before you return the unit. This will allow the service technician an opportunity to provide any other suggestions for identifying the problem and to recommend possible solutions.

Factory Service

If you return equipment for repair, please get a Return Material Authorization Number (RMA) from the factory first.

Ship the product and a written description of the problem to:

Ensemble Designs, Inc.
Attention: Customer Service RMA #####
870 Gold Flat Rd.
Nevada City, CA. 95959 USA

Tel: (530) 478-1830
Fax: (530) 478-1832

service@ensembledesigns.com

<http://www.ensembledesigns.com>

Be sure to put your RMA number on the outside of the box.

Specifications

Reference Input

Number	One
Signal Type	1V P-P PAL, NTSC, 10 MHz or Tri Level Sync
Return Loss	>40 dB to 5.5 MHz

Composite Output

Number	Two
Signal Type	NTSC / PAL
Impedance	75 Ω
Return Loss	>40 dB to 5.5 MHz
Frequency Response	-0.1 dB 10 KHz to 5.0 MHz
Output DC	± 50 mV
K Factor	<1.0%
Differential Phase	<1.0 degree
SCH Phase	± 5 degrees

Accuracy and Timing Stability

Internal	TCXO
PAL Fsc	4.43361875 MHz +/- 1 Hz
NTSC Fsc	3.579545 MHz +/- 1 Hz
601 Fs	27.000000 MHz +/- 5 Hz
Long Term Drift	<1 ppm/year
Analog Jitter	<1 ns
Digital Jitter	<0.2 UI (0.13 UI typical)

Serial Digital Output

Number	Two
Signal Type	270 Mb/s SD Serial Digital (SMPTE 259M) 1.485 Gb/s HD Serial Digital (SMPTE 274M, 292M or 296M) 2.97 Gb/s HD Serial Digital (SMPTE 424M, 425M)
Return Loss	>15 dB for 270 Mb/s >15 dB for 1.485 Gb/s
Max Cable Length	300 meters for 270 Mb/s 100 meters for 1.485 Gb/s 70 meters for 2.97 Gb/s (Belden 1694A)

Tri Level Sync Output

Number	Two, 75 Ω
Output	DC ± 50 mV
Return Loss	>30 dB to 30 MHz

Standards Supported

1080i (SMPTE 274M -4, 5, 6) 50, 59.94 or 60 Hz
 720p (SMPTE 296M -1, 2, 3) 50, 59.94 or 60 Hz
 1080p (SMPTE 274M -9, 10, 11) 23.98, 24, 25 Hz
 1080sF (RP211 -14, 15, 16) 23.98, 24, 25 Hz
 3 Gb/s Level A or Level B (SMPTE 424M, 425M)
 625i 50, 525i 59.94, Composite PAL, NTSC

AES Audio Output

Number One
 Type AES3id, 1 KHz tone or silence
 Resolution 24 bit

Analog Audio Output

Number One stereo pair or two mono
 Type 1 KHz tone or silence
 Impedance 30 Ω , balanced
 Reference Level -10 to + 4 dBu, adjustable

Programmable Outputs

Number Three
 Type Selectable between AES, LTC, VITC, Word Clock or 6 Hz Pulse
 Impedance 75 Ω

Flash Memory

Number One
 Type Secure Digital SD Flash Memory Card
 Size 1 MB card included

File Type

Video .tga
 Audio .wav, .mp3, .wma

General Specifications

Size 5.625" W x 1.7" H x 5.5" D
 (143 mm x 40 mm x 140 mm) including connectors
 Weight 1 lb 7 oz
 Power 12 volts, 12 watts
 (100-230 VAC modular power supply not included)
 Temperature Range 0 to 40° C ambient
 Relative Humidity 0 to 95%, non-condensing
 Altitude 0 to 10,000 ft.

Due to ongoing product development, all specifications are subject to change.

Glossary

AES/EBU

The digital audio standard defined as a joint effort of the Audio Engineering Society and the European Broadcast Union. AES/EBU or AES3 describes a serial bitstream that carries two audio channels, thus an AES stream is a stereo pair. The AES/EBU standard covers a wide range of sample rates and quantizations (bit depths). In television systems, these will generally be 48 KHz and either 20 or 24 bits.

AFD

Active Format Description is a method to carry information regarding the aspect ratio of the video content. The specification of AFD was standardized by SMPTE in 2007 and is now beginning to appear in the marketplace. AFD can be included in both SD and HD SDI transport systems. There is no legacy analog implementation. (See WSS).

ASI

A commonly used transport method for MPEG video streams, ASI or Asynchronous Serial Interface, operates at the same 270 Mb/s data rate as SD SDI. This makes it easy to carry an ASI stream through existing digital television infrastructure. Known more formally as DVB-ASI, this transport mechanism can be used to carry multiple program channels.

Aspect Ratio

The ratio of the vertical and horizontal measurements of an image. 4:3 is the aspect ratio for standard definition video formats and television and 16:9 for high definition. Converting formats of unequal ratios is done by letterboxing (horizontal bars) or pillar boxing (vertical pillars) in order to keep the original format's aspect ratio.

Bandwidth

Strictly speaking, this refers to the range of frequencies (i.e. the width of the band of frequency) used by a signal, or carried by a transmission channel. Generally, wider bandwidth will carry and reproduce a signal with greater fidelity and accuracy.

Beta

Sony Beta SP video tape machines use an analog component format that is similar to SMPTE, but differs in the amplitude of the color difference signals. It may also carry setup on the luminance channel.

Bit

A binary digit, or bit, is the smallest amount of information that can be stored or transmitted digitally by electrical, optical, magnetic, or other means. A single bit can take on one of two states: On/Off, Low/High, Asserted/ Deasserted, etc. It is represented numerically by the numerals 1 (one) and 0 (zero). A byte, containing 8 bits, can represent 256 different states. The binary number 11010111, for example, has the value of 215 in our base 10 numbering system. When a value is carried digitally, each

additional bit of resolution will double the number of different states that can be represented. Systems that operate with a greater number of bits of resolution, or quantization, will be able to capture a signal with more detail or fidelity. Thus, a video digitizer with 12 bits of resolution will capture 4 times as much detail as one with 10 bits.

Blanking

The Horizontal and Vertical blanking intervals of a television signal refer to the time periods between lines and between fields. No picture information is transmitted during these times, which are required in CRT displays to allow the electron beam to be repositioned for the start of the next line or field. They are also used to carry synchronizing pulses which are used in transmission and recovery of the image. Although some of these needs are disappearing, the intervals themselves are retained for compatibility purposes. They have turned out to be very useful for the transmission of additional content, such as teletext and embedded audio.

CAV

Component Analog Video. This is a convenient shorthand form, but it is subject to confusion. It is sometimes used to mean ONLY color difference component formats (SMPTE or Beta), and other times to include RGB format. In any case, a CAV signal will always require 3 connectors – either Y/R-Y/B-Y, or R/G/B.

Checkfield

A Checkfield signal is a special test signal that stresses particular aspects of serial digital transmission. The performance of the Phase Locked-Loops (PLLs) in an SDI receiver must be able to tolerate long runs of 0's and 1's. Under normal conditions, only very short runs of these are produced due to a scrambling algorithm that is used. The Checkfield, also referred to as the Pathological test signal, will "undo" the scrambling and cause extremely long runs to occur. This test signal is very useful for testing transmission paths.

Chroma

The color or chroma content of a signal, consisting of the hue and saturation of the image. See also Color Difference.

Component

In a component video system, the totality of the image is carried by three separate but related components. This method provides the best image fidelity with the fewest artifacts, but it requires three independent transmission paths (cables). The commonly used component formats are Luminance and Color Difference (Y/Pr/Pb), and RGB. It was far too unwieldy in the early days of color television to even consider component transmission.

Composite

Composite television dates back to the early days of color transmission. This scheme encodes the color difference information onto a color subcarrier. The instantaneous phase of the subcarrier is the color's hue, and the amplitude is the color's saturation or intensity. This subcarrier is then added onto the existing luminance video signal. This trick works because the subcarrier is set at a high enough frequency to leave spectrum for the luminance information. But it is not a seamless matter to pull

the signal apart again at the destination in order to display it or process it. The resultant artifacts of dot crawl (also referred to as chroma crawl) are only the most obvious result. Composite television is the most commonly used format throughout the world, either as PAL or NTSC. It is also referred to as Encoded video.

Color Difference

Color Difference systems take advantage of the details of human vision. We have more acuity in our black and white vision than we do in color. This means that we need only the luminance information to be carried at full bandwidth, we can scrimp on the color channels. In order to do this, RGB information is converted to carry all of the luminance (Y is the black and white of the scene) in a single channel. The other two channels are used to carry the “color difference”. Noted as B-Y and R-Y, these two signals describe how a particular pixel “differs” from being purely black and white. These channels typically have only half the bandwidth of the luminance.

Decibel (dB)

The decibel is a unit of measure used to express the ratio in the amplitude or power of two signals. A difference of 20 dB corresponds to a 10:1 ratio between two signals, 6 dB is approximately a 2:1 ratio. Decibels add while the ratios multiply, so 26 dB is a 20:1 ratio, and 14 dB is a 5:1 ratio. There are several special cases of the dB scale, where the reference is implied. Thus, dBm refers to power relative to 1 milliwatt, and dBu refers to voltage relative to .775V RMS. The original unit of measure was the Bel (10 times bigger), named after Alexander Graham Bell.

dBFS

In Digital Audio systems, the largest numerical value that can be represented is referred to as Full Scale. No values or audio levels greater than FS can be reproduced because they would be clipped. The nominal operating point (roughly corresponding to 0 VU) must be set below FS in order to have headroom for audio peaks. This operating point is described relative to FS, so a digital reference level of -20 dBFS has 20 dB of headroom before hitting the FS clipping point.

DVI

Digital Visual Interface. DVI-I (integrated) provides both digital and analog connectivity. The larger group of pins on the connector are digital while the four pins on the right are analog.

EDH

Error Detection and Handling is a method to verify proper reception of an SDI or HD-SDI signal at the destination. The originating device inserts a data packet in the vertical interval of the SDI signal and every line of the HD signal which contains a checksum of the entire video frame. This checksum is formed by adding up the numerical values of all of the samples in the frame, using a complex formula. At the destination this same formula is applied to the incoming video and the resulting value is compared to the one included in the transmission. If they match, then the content has all arrived with no errors. If they don't, then an error has occurred.

Embedded Audio

Digital Audio can be carried along in the same bitstream as an SDI or HD-SDI signal by taking advantage of the gaps in the transmission which correspond to the horizontal and vertical intervals

of the television waveform. This technique can be very cost effective in transmission and routing, but can also add complexity to signal handling issues because the audio content can no longer be treated independently of the video.

Eye Pattern

To analyze a digital bitstream, the signal can be displayed visually on an oscilloscope by triggering the horizontal timebase with a clock extracted from the stream. Since the bit positions in the stream form a very regular cadence, the resulting display will look like an eye – an oval with slightly pointed left and right ends. It is easy to see from this display if the eye is “open”, with a large central area that is free of negative or positive transitions, or “closed” where those transitions are encroaching toward the center. In the first case, the open eye indicates that recovery of data from the stream can be made reliably and with few errors. But in the closed case data will be difficult to extract and bit errors will occur. Generally it is jitter in the signal that is the enemy of the eye.

Frame Sync

A Frame Synchronizer is used to synchronize the timing of a video signal to coincide with a timing reference (usually a color black signal that is distributed throughout a facility). The synchronizer accomplishes this by writing the incoming video into a frame buffer memory under the timing direction of the sync information contained in that video. Simultaneously the memory is being read back by a timing system that is genlocked to a house reference. As a result, the timing or alignment of the video frame can be adjusted so that the scan of the upper left corner of the image is happening simultaneously on all sources. This is a requirement for both analog and digital systems in order to perform video effects or switch glitch-free in a router. Frame synchronization can only be performed within a single television line standard. A synchronizer will not convert an NTSC signal to a PAL signal, it takes a standards converter to do that.

Frequency Response

A measurement of the accuracy of a system to carry or reproduce a range of signal frequencies. Similar to Bandwidth.

H.264

The latest salvo in the compression wars is H.264 which is also known as MPEG-4 Part 10. MPEG-4 promises good results at just half the bit rate required by MPEG-2.

HD

High Definition. This two letter acronym has certainly become very popular. Here we thought it was all about the pictures – and the radio industry stole it.

HDMI

The High Definition Multimedia Interface comes to us from the consumer marketplace where it is becoming the de facto standard for the digital interconnect of display devices to audio and video sources. It is an uncompressed, all-digital interface that transmits digital video and eight channels of digital audio. HDMI is a bit serial interface that carries the video content in digital component form over multiple twisted-pairs. HDMI is closely related to the DVI interface for desktop computers and their displays.

IEC

The International Electrotechnical Commission provides a wide range of worldwide standards. They have provided standardization of the AC power connection to products by means of an IEC line cord. The connection point uses three flat contact blades in a triangular arrangement, set in a rectangular connector. The IEC specification does not dictate line voltage or frequency. Therefore, the user must take care to verify that a device either has a universal input (capable of 90 to 230 volts, either 50 or 60 Hz), or that a line voltage switch, if present, is set correctly.

Interlace

Human vision can be fooled to see motion by presenting a series of images, each with a small change relative to the previous image. In order to eliminate the flicker, our eyes need to see more than 30 images per second. This is accomplished in television systems by dividing the lines that make up each video frame (which run at 25 or 30 frames per second) into two fields. All of the odd-numbered lines are transmitted in the first field, the even-numbered lines are in the second field. In this way, the repetition rate is 50 or 60 Hz, without using more bandwidth. This trick has worked well for years, but it introduces other temporal artifacts. Motion pictures use a slightly different technique to raise the repetition rate from the original 24 frames that make up each second of film—they just project each one twice.

IRE

Video level is measured on the IRE scale, where 0 IRE is black, and 100 IRE is full white. The actual voltages that these levels correspond to can vary between formats.

ITU-R 601

This is the principal standard for standard definition component digital video. It defines the luminance and color difference coding system that is also referred to as 4:2:2. The standard applies to both PAL and NTSC derived signals. They both will result in an image that contains 720 pixels horizontally, with 486 vertical pixels in NTSC, and 576 vertically in PAL. Both systems use a sample clock rate of 27 MHz, and are serialized at 270 Mb/s.

Jitter

Serial digital signals (either video or audio) are subject to the effects of jitter. This refers to the instantaneous error that can occur from one bit to the next in the exact position of each digital transition. Although the signal may be at the correct frequency on average, in the interim it varies. Some bits come slightly early, others come slightly late. The measurement of this jitter is given either as the amount of time uncertainty or as the fraction of a bit width. For 270 Mb/s SD video, the allowable jitter is 740 picoseconds, or 0.2 UI (Unit Interval – one bit width). For 1.485 Gb/s HD, the same 0.2UI spec corresponds to just 135 pico seconds.

Luminance

The “black & white” content of the image. Human vision had more acuity in luminance, so television systems generally devote more bandwidth to the luminance content. In component systems, the luminance is referred to as Y.

MPEG

The Moving Picture Experts Group is an industry group that develops standards for the compression of moving pictures for television. Their work is an on-going effort. The understanding of image processing and information theory is constantly expanding. And the raw bandwidth of both the hardware and software used for this work is ever increasing. Accordingly, the compression methods available today are far superior to the algorithms that originally made the real-time compression and decompression of television possible. Today, there are many variations of these techniques, and the term MPEG has to some extent become a broad generic label.

Metadata

This word comes from the Greek, meta means 'beyond' or 'after'. When used as a prefix to 'data', it can be thought of as 'data about the data'. In other words, the metadata in a data stream tells you about that data – but it is not the data itself. In the television industry, this word is sometimes used correctly when, for example, we label as metadata the timecode which accompanies a video signal. That timecode tells you something about the video, i.e. when it was shot, but the timecode in and of itself is of no interest. But in our industry's usual slovenly way in matters linguistic, the term metadata has also come to be used to describe data that is associated with the primary video in a datastream. So embedded audio will (incorrectly) be called metadata when it tells us nothing at all about the pictures. Oh well.

Multi-mode

Multi-mode fibers have a larger diameter core than single mode fibers (either 50 or 62.5 microns compared to 9 microns), and a correspondingly larger aperture. It is much easier to couple light energy into a multi-mode fiber, but internal reflections will cause multiple "modes" of the signal to propagate down the fiber. This will degrade the ability of the fiber to be used over long distances. See also Single Mode.

NTSC

The color television encoding system used in North America was originally defined by the National Television Standards Committee. This American standard has also been adopted by Canada, Mexico, Japan, Korea, and Taiwan. (This standard is referred to disparagingly as Never Twice Same Color.)

Optical

An optical interface between two devices carries data by modulating a light source. This light source is typically a laser or laser diode (similar to an LED) which is turned on and off at the bitrate of the datastream. The light is carried from one device to another through a glass fiber. The fiber's core acts as a waveguide or lightpipe to carry the light energy from one end to another. Optical transmission has two very significant advantages over metallic copper cables. Firstly, it does not require that the two endpoint devices have any electrical connection to each other. This can be very advantageous in large facilities where problems with ground loops appear. And secondly, and most importantly, an optical interface can carry a signal for many kilometers or miles without any degradation or loss in the recovered signal. Copper is barely useful at distances of just 1000 feet.

Oversampling

A technique to perform digital sampling at a multiple of the required sample rate. This has the advantage of raising the Nyquist Rate (the maximum frequency which can be reproduced by a given sample rate) much higher than the desired passband. This allows more easily realized anti-aliasing filters.

PAL

During the early days of color television in North America, European broadcasters developed a competing system called Phase Alternation by Line. This slightly more complex system is better able to withstand the differential gain and phase errors that appear in amplifiers and transmission systems. Engineers at the BBC claim that it stands for Perfection At Last.

Pathological Test Pattern – see Checkfield

Progressive

An image scanning technique which progresses through all of the lines in a frame in a single pass. Computer monitors all use progressive displays. This contrasts to the interlace technique common to television systems.

Return Loss

An idealized input or output circuit will exactly match its desired impedance (generally 75 ohms) as a purely resistive element, with no reactive (capacitive or inductive) elements. In the real world, we can only approach the ideal. So, our real inputs and outputs will have some capacitance and inductance. This will create impedance matching errors, especially at higher frequencies. The Return Loss of an input or output measures how much energy is returned (reflected back due to the impedance mismatch). For digital circuits, a return loss of 15 dB is typical. This means that the energy returned is 15 dB less than the original signal. In analog circuits, a 40 dB figure is expected.

RGB

RGB systems carry the totality of the picture information as independent Red, Green, and Blue signals. Television is an additive color system, where all three components add to produce white. Because the luminance (or detail) information is carried partially in each of the RGB channels, all three must be carried at full bandwidth in order to faithfully reproduce an image.

Sch Phase

Used in composite systems, Sch Phase measures the relative phase between the leading edge of sync on line 1 of field 1 and a continuous subcarrier sine wave. Due to the arithmetic details of both PAL and NTSC, this relationship is not the same at the beginning of each frame. In PAL, the pattern repeats every 4 frames (8 fields) which is also known as the Bruch Blanking sequence. In NTSC, the repeat is every 2 frames (4 fields). This creates enormous headaches in editing systems and the system timing of analog composite facilities.

Setup

In the NTSC Analog Composite standard, the term Setup refers to the addition of an artificial offset or pedestal to the luminance content. This places the Black Level of the analog signal 54 mV (7.5 IRE) positive with respect to ground. The use of Setup is a legacy from the early development of television receivers in the vacuum tube era. This positive offset helped to prevent the horizontal retrace of the electron beam from being visible on the CRT, even if Brightness and Contrast were mis-adjusted. While the use of Setup did help to prevent retrace artifacts, it did so at the expense of dynamic range (contrast) in the signal because the White Level of the signal was not changed.

Setup is optional in NTSC systems, but is never used in PAL systems (see 'Perfection' characteristic of PAL). This legacy of Setup continues to persist in North American NTSC systems, while it has been abandoned in Japan.

In the digital component world (SD and HD SDI) there is obviously no need for, and certainly every reason to avoid, Setup. In order for the interfaces between analog and digital systems to operate as transparently as possible, Setup must be carefully accounted for in conversion products. When performing analog to digital conversion, Setup (if present) must be removed and the signal range gained up to account for the 7.5% reduction in dynamic range. And when a digital signal is converted back to analog form, Setup (if desired on the output) must be created by reducing the dynamic range by 7.5% and adding the 54 mV positive offset. Unfortunately, there is no truly foolproof algorithm to detect the presence of Setup automatically, so it's definitely a case of installer beware.

SDI

Serial Digital Interface. This term refers to inputs and outputs of devices that support serial digital component video. This could refer to standard definition at 270 Mb/s, HD SDI or High Definition Serial Digital video at 1.485 Gb/s, or to the newer 3G standard of High Definition video at 2.97 Gb/s.

SMPTE

The Society of Motion Picture and Television Engineers is a professional organization which has done tremendous work in setting standards for both the film and television industries. The term "SMPTE" is also shorthand for one particular component video format - luminance and color difference.

Single Mode

A Single mode (or mono mode) optical fiber carries an optical signal on a very small diameter (9 micron) core surrounded with cladding. The small diameter means that no internally reflected lightwaves will be propagated. Thus only the original "mode" of the signal passes down the fiber. A single mode fiber used in an optical SDI system can carry a signal for up to 20 kilometers. Single mode fibers require particular care in their installation due to the extremely small optical aperture that they present at splice and connection points. See also Multi-mode.

TBC

A Time Base Corrector is a system to reduce the Time Base Error in a signal to acceptable levels. It accomplishes this by using a FIFO (First In, First Out) memory. The incoming video is written into the memory using its own jittery timing. This operation is closely associated with the actual digitization of the analog signal because the varying position of the sync timing must be mimicked by the sampling function of the analog to digital converter. A second timing system, genlocked to a stable reference,

is used to read the video back out of the memory. The memory acts as a dynamically adjusting delay to smooth out the imperfections in the original signal's timing. Very often a TBC will also function as a Frame Synchronizer. See also Frame Sync.

Time Base Error

Time base error is present when there is excessive jitter or uncertainty in the line to line output timing of a video signal. This is commonly associated with playback from video tape recorders, and is particularly severe with consumer type heterodyne systems like VHS. Time base error will render a signal unusable for broadcast or editing purposes.

Timecode

Timecode, a method to uniquely identify and label every frame in a video stream, has become one of the most recognized standards ever developed by SMPTE. It uses a 24 hour clock, consisting of hours, minutes, seconds, and television frames. Originally recorded on a spare audio track, this 2400 baud signal was a significant contributor to the development of video tape editing. We now refer to this as LTC or Longitudinal Time Code because it was carried along the edge of the tape. This allowed it to be recovered in rewind and fast forward when the picture itself could not. Timecode continues to be useful today and is carried in the vertical interval as VITC, and as a digital packet as DVITC. Timecode is the true metadata.

Tri-Level Sync

For many, many years, television systems used composite black as a genlock reference source. This was a natural evolution from analog systems to digital implementations. With the advent of High Definition television, with even higher data rates and tighter jitter requirements, problems with this legacy genlock signal surfaced. Further, a reference signal with a 50 or 60 Hz frame rate was useless with 24 Hz HD systems running at film rates. Today we can think of composite black as a bi-level sync signal – it has two levels, one at sync tip and one at blanking. For HD systems, Tri-Level Sync, which has the same blanking level (at ground) of bi-level sync, but the sync pulse now has both a negative and a positive element. This keeps the signal symmetrically balanced so that its DC content is zero. And it also means that the timing pickoff point is now at the point where the signal crosses blanking and is no longer subject to variation with amplitude. This makes Tri-Level Sync a much more robust signal and one which can be delivered with less jitter.

USB

The Universal Serial Bus, developed in the computer industry to replace the previously ubiquitous RS-232 serial interface, now appears in many different forms and with many different uses. It actually forms a small local area network, allowing multiple devices to coexist on a single bus where they can be individually addressed and accessed.

VGA

Video Graphics Array. Traditional 15-pin, analog interface between a PC and monitor.

Word Clock

Use of Word Clock to genlock digital audio devices developed in the audio recording industry. Early digital audio products were interconnected with a massive parallel connector carrying a twisted pair

for every bit in the digital audio word. A clock signal, which is a square wave at the audio sampling frequency, is carried on a 75 ohm coaxial cable. Early systems would daisychain this 44.1 or 48 kilohertz clock from one device to another with coax cable and Tee connectors. On the rising edge of this Word Clock these twisted pairs would carry the left channel, while on the falling edge, they would carry the right channel. In most television systems using digital audio, the audio sample clock frequency (and hence the 'genlock' between the audio and video worlds) is derived from the video genlock signal. But products that are purely audio, with no video reference capability, may still require Word Clock.

WSS

Wide Screen Signaling is used in the PAL/625 video standards, both in analog and digital form, to convey information about the aspect ratio and format of the transmitted signal. Carried in the vertical interval, much like closed captioning, it can be used to signal a television receiver to adjust its vertical or horizontal sizing to reflect incoming material. Although an NTSC specification for WSS exists, it never achieved any traction in the marketplace.

YUV

Strictly speaking, YUV does not apply to component video. The letters refer to the Luminance (Y), and the U and V encoding axes using in the PAL composite system. Since the U axis is very close to the B-Y axis, and the V axis is very close to the R-Y axis, YUV is often used as a sort of shorthand for the more long-winded "Y/R-Y/B-Y".

Y/Cr/Cb

In digital component video, the luminance component is Y, and the two color difference signals are Cr (R-Y) and Cb (B-Y).

Y/Pr/Pb

In analog component video, the image is carried in three components. The luminance is Y, the R-Y color difference signal is Pr, and the B-Y color difference signal is Pb.