



BrightEye™ 92-M

HD Downconverter User Guide

ENSEMBLE

D E S I G N S

Revision 2.4 SW v1.2.3

This user guide provides detailed information for using the **BrightEye 92-M** HD downconverter. The information is organized into the following sections:

- Product Overview
- Functional Description
- Applications
- Rear Connectors
- Operation
 - Front Panel Controls and Indicators
 - Using the BrightEye Control Application
- Warranty and Factory Service
- Specifications
- Glossary

PRODUCT OVERVIEW

BrightEye 92-M is a flexible, configurable downconverter with analog and digital outputs. It downconverts high definition (HD) signals into standard definition (SD) and performs aspect ratio conversion as needed. The built-in frame synchronizer handles any asynchronous signals fed to the unit.

Audio is bypassed around the video processing in order to preserve lip sync. Up to sixteen channels of embedded audio are supported. You can select one pair to monitor through the Audio Monitor headphone jack from the **Audio Out** menu.

The rear-panel HDMI output connector is compatible with many LCD monitors and allows confidence monitoring of signal feeds.

Basic controls are accessed on the front panel. BrightEye PC and Mac Control applications provide access to video processing functions.

FUNCTIONAL DESCRIPTION

As shown in the diagram below, HD video is fed to the serial digital receiver and the frame synchronized to the reference input. Audio is demuxed and passed around the downconversion process. The video is downconverted to standard definition.

The video and audio signals are joined in the embedder. This embedded signal passes through a serializer to the SD-SDI outputs. Additionally an analog composite output is provided. The HDMI connector outputs the same video signal that appears on the SDI and composite outputs. Two channels of audio can be monitored on the headphone jack.

BrightEye 92-M is powered by a 12 volt DC universal power supply. This power supply can accept an input voltage between 100 and 230 volts, at 50 or 60 Hertz. It uses a standard IEC line cord and can be used anywhere in the world. It is normal for the converter to be quite warm to the touch when operating.

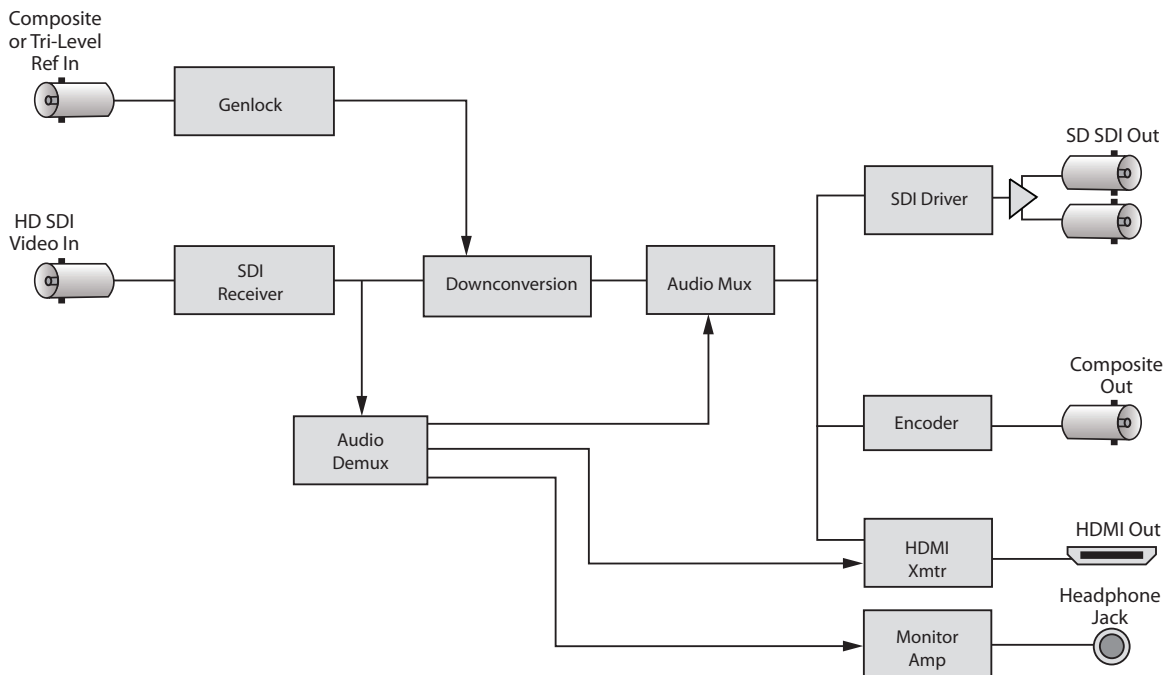

Provides embedded pass through of all 16 audio channels

BrightEye 92-M Functional Block Diagram

PERFORMANCE ADVANTAGES OF THE BRIGHT EYE SERIES

When images are converted between different formats, color spaces, and resolution geometries, the need for accuracy and fidelity are extremely important. Whether upconverting from standard definition to HD formats, converting between different HD formats, or downconverting to SD, extra care must be paid to every aspect of the signal and the content of the images. The BrightEye series of up, down, and cross converters were designed specifically with this in mind and provide the highest possible level of signal processing quality.

Key aspects of this design are:

- 1) The Standard Definition analog inputs and outputs feature 12-bit quantization, with 4-times oversampling and 4:4:4 internal processing. This allows for better separation of real image content from artifacts.
- 2) The RF aspects of the electrical performance of the SDI inputs and outputs have been carefully optimized for reliable and dependable SDI I/O performance even under adverse conditions.
- 3) Input signals are upsampled to 4:4:4 spatial resolution in RGB colorspace and adaptively de-interlaced. This enables all of the geometrical conversions of the image to be performed in the Progressive domain. This enhancement to the temporal resolution of the image is a key contributor to final image quality, even if the final output is interlaced.
- 4) The colorspace and geometrical conversions of the signal are performed at up to 16 bits of resolution.
- 5) The final output signal is built from this intermediate progressive workspace, which is the most uncompromised version of the image possible. It provides the best possible starting point from which to create the final output signal.

APPLICATIONS

HD Downconversion 1

As shown in the example below, the HD ingest signal from a satellite is fed to a BE 92-M where it is downconverted to feed an SD Master Control Switcher. The other output can be sent to another SD destination.

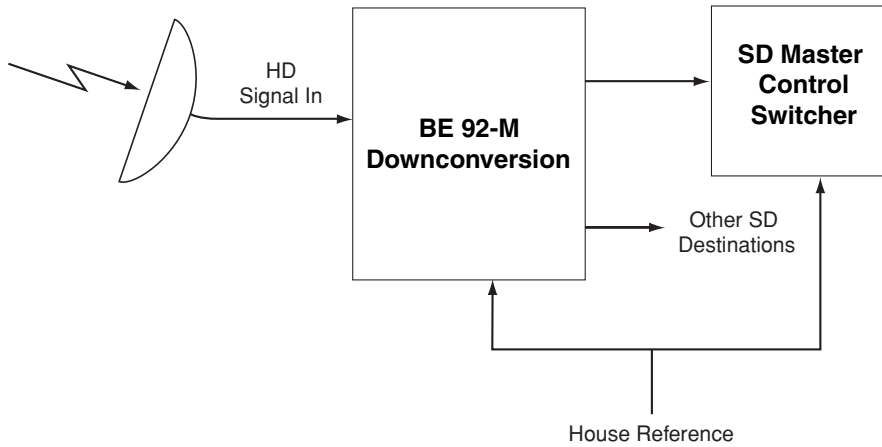

HD Downconversion 2

As shown in the example below, the BrightEye 92-M can be used to monitor material originated in HD. The BrightEye 92-M can output signals to feed a server, video monitor and HDMI display simultaneously.

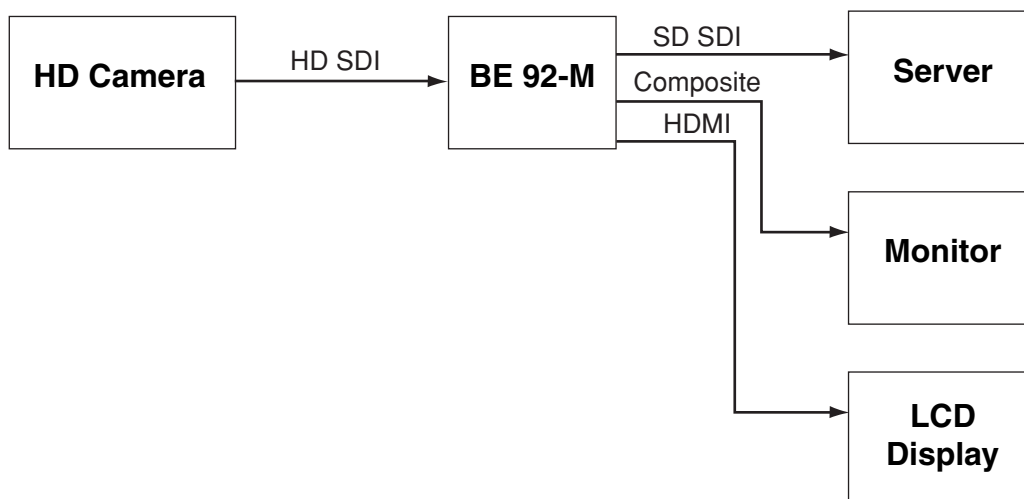

REAR CONNECTORS

All connections to the BrightEye 92-M are made on the rear of the unit. Refer to the photo below.



BrightEye 92-M Rear Connectors

Power Connection

Connect a modular power supply to the 12 volt DC power input connection on the far left of the unit. Use the locking ring to secure it.

USB Connector

Connect a PC or Mac to the USB connector to enable more comprehensive control, diagnostics, and upgrades to the BE 92-M. Use the BrightEye PC or Mac application included on CD-ROM to make adjustments as described in the **OPERATION** section of this user guide.

HDMI Out

Connect an LCD monitor to this port for confidence monitoring of a video feed.

Audio Monitor

Connect a headset to this 3.5 mm mini jack to monitor the pair of audio channels selected from the **Mon Assign** control on the **Audio Out** menu.

Input/Output BNCs

There are five rear BNC connectors used as inputs and outputs as follows:

SD SDI Out

This BNC outputs a timed standard definition SDI video signal with embedded audio.

SD SDI Out

This BNC also outputs a timed SD SDI video signal with embedded audio.

Cpst Out

This BNC outputs a timed analog composite (NTSC or PAL) video signal.

HD SDI In

This BNC input accepts an HD SDI serial digital video signal with or without embedded audio.

Ref In

This BNC accepts an analog composite video signal or Tri-Level Sync reference which is used as the genlock and timing reference for the internal Frame Synchronizer. Typically the reference signal is Color Black or Color Bars fed from a master sync generator (such as the BrightEye 55).

OPERATION

Control and operation of the BrightEye 92-M is performed from the front panel or remotely from a networked PC with the BrightEye PC or BrightEye Mac Control application.

NOTE: *Some control settings are only available with BrightEye PC or Mac. These parameters cannot be monitored or controlled from the front panel.*

Front Panel Controls and Indicators

The front panel of the BrightEye 92-M, shown below, provides status and control indicators for the module.

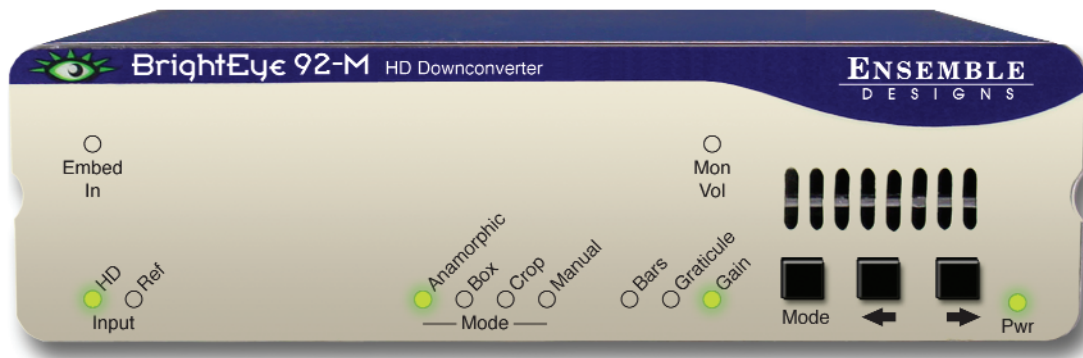

BrightEye 92-M Front Panel

Status Indicators

The following status indicators and controls are provided on the front panel:

Embed In

Illuminates green when an embedded audio stream is detected on the **HD SDI In** video input BNC.

Mon Vol (Monitor Volume)

Illuminates green when audio monitor volume is set to unity, or red when set to other than unity. This control affects the audio headset jack output.

Input

Illuminated green when a valid HD video signal is detected on the **HD SDI In** video input BNC. **Ref** (Reference) illuminates green when a valid composite or Tri-Level Sync reference is detected on the **Ref** input BNC.

Mode

Indicates the output aspect ratio of the output signal. Choices are:

- **Anamorphic** – original material shrinks as needed to 4:3.
- **Box** – Letter Box: horizontal bars are added to the top and bottom of the original material.
- **Crop** – right and left edges are cropped off the original material.
- **Manual** – illuminates green when the output aspect ratio has been set manually.

Bars

Illuminates green when color bars are selected for the output.

Graticule

Illuminates green when the on-screen aspect ratio graticule is displayed.

Gain

Illuminates green when video gain is set to unity, or red when set to other than unity.

Pwr (Power)

Illuminates green when power is applied to the unit and the internal voltage regulator is functioning correctly.

ADJUSTING PARAMETERS FROM THE FRONT PANEL

Use the **Mode**, **Right Arrow**, and **Left Arrow** buttons to select and adjust parameters from the front panel.

Pressing the **Mode** button activates the front panel for editing and tabs between each section of editable parameters.

Pressing the **Right Arrow** or **Left Arrow** advances the selection within a given section of parameters, or increases (Right Arrow) or decreases (Left Arrow) the value of a selected parameter.

NOTE: *The LED of an edited parameter will blink for 15 seconds, after which time its value is stored in memory. If power is interrupted before this 15 second timeout period has elapsed, the edited state will not be saved.*

USING THE BRIGHT EYE CONTROL APPLICATION

The BrightEye PC and BrightEye Mac applications included on CD-ROM are designed to allow you to configure and control the BrightEye 92-M from a personal computer. Installation and instructions for using this software application are given in the PDF manual on disk.

BrightEye PC/Mac Control application software is included on CD that came with your unit, or the application can be downloaded here:

<http://www.ensembledesigns.com/support/brighteye-support/>

If the BrightEye 92-M is connected to a computer running this software, the following menus are available for controlling and monitoring the unit.

Video In

- **Input Pres** – indicates the status of the video input (**720p/50, 720p/59.94, 720p/60, 1080i/50, 1080i/59.94, 1080i/60, 1080p/25, 1080p/23.98, 1080p/24, 1080sF/25, 1080sF/23.98, 1080sF/24, No Input, or Unknown.**)
- **Captions In** – indicates the presence of closed captioned material on the input signal (**None, Line 21, CEA 708**). The BrightEye 92-M translates between CEA-608 and CEA-708 standards for closed captioning as needed.
- **Ref Source** – use this control to set the reference input source. **Video In Ref** indicates that the SD video output will be locked to the incoming video signal. **Ext Ref** indicates that the SD video output will be locked to the external reference input.
- **Reference** – indicates the status of a reference video presence (**Ref Mismatch, Ref Unlocked, Ref TLS Lock, No Reference, Ref 525 Lock, Ref 625 Lock**).

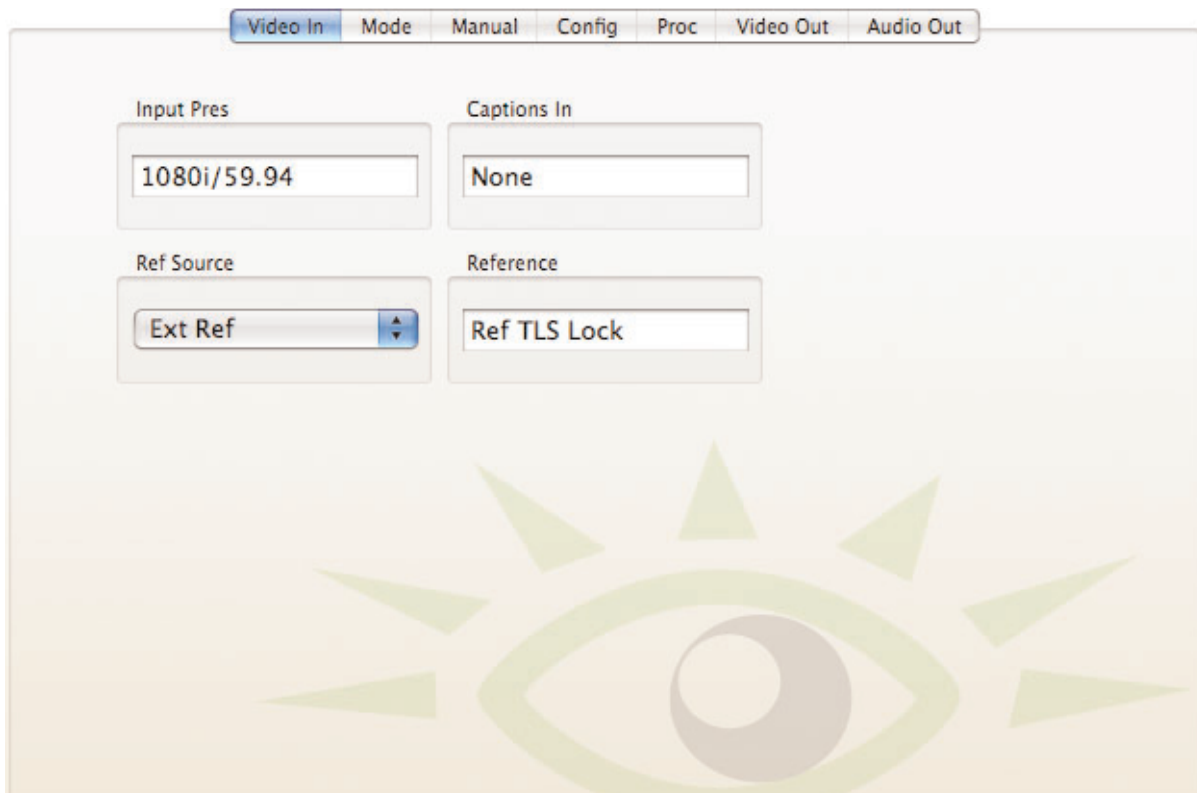

Mode

- **Mode** – use this control to set the aspect ratio for the downconverted SD video output. (**Anamorphic**, **Letter Box 16:9**, **Letter Box 14:9**, **Crop**, **Manual**). When **Manual** is selected, use the **Manual** menu to set the aspect ratio.

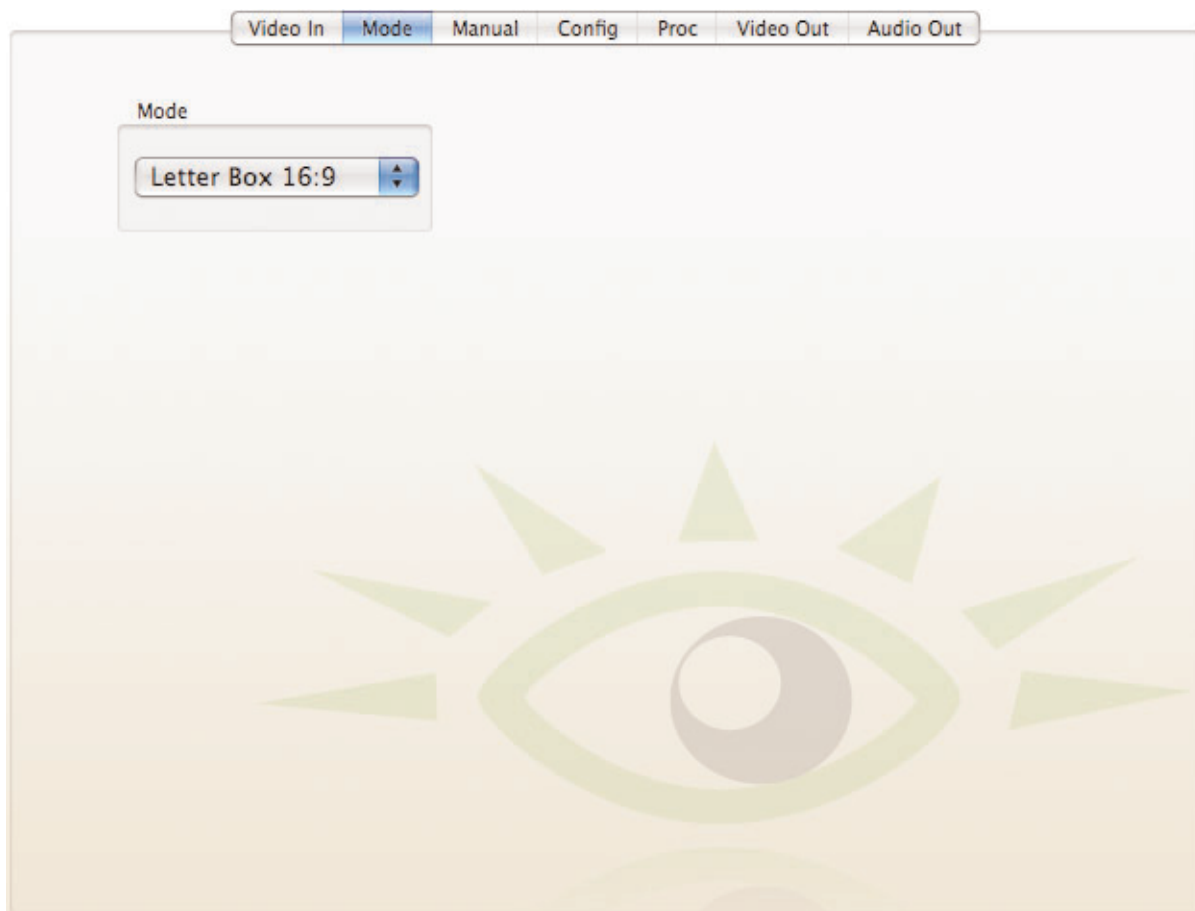

Manual

- **Width** – sets the aspect ratio width in percent (range is **30** to **145%**, default is **100%**).
- **Height** – sets the aspect ratio height in percent (range is **30** to **140%**, default is **100%**).
- **Hor Position** – sets the horizontal position of the output (range is **-100** to **100**, default is **0**).
- **Ver Position** – sets the vertical position of the output (range is **-100** to **100**, default is **0**).

Make adjustments by clicking and dragging the slider controls, by using the up and down arrow buttons, or by entering a value directly into the field. Click the **Default** buttons to return settings to their default values.

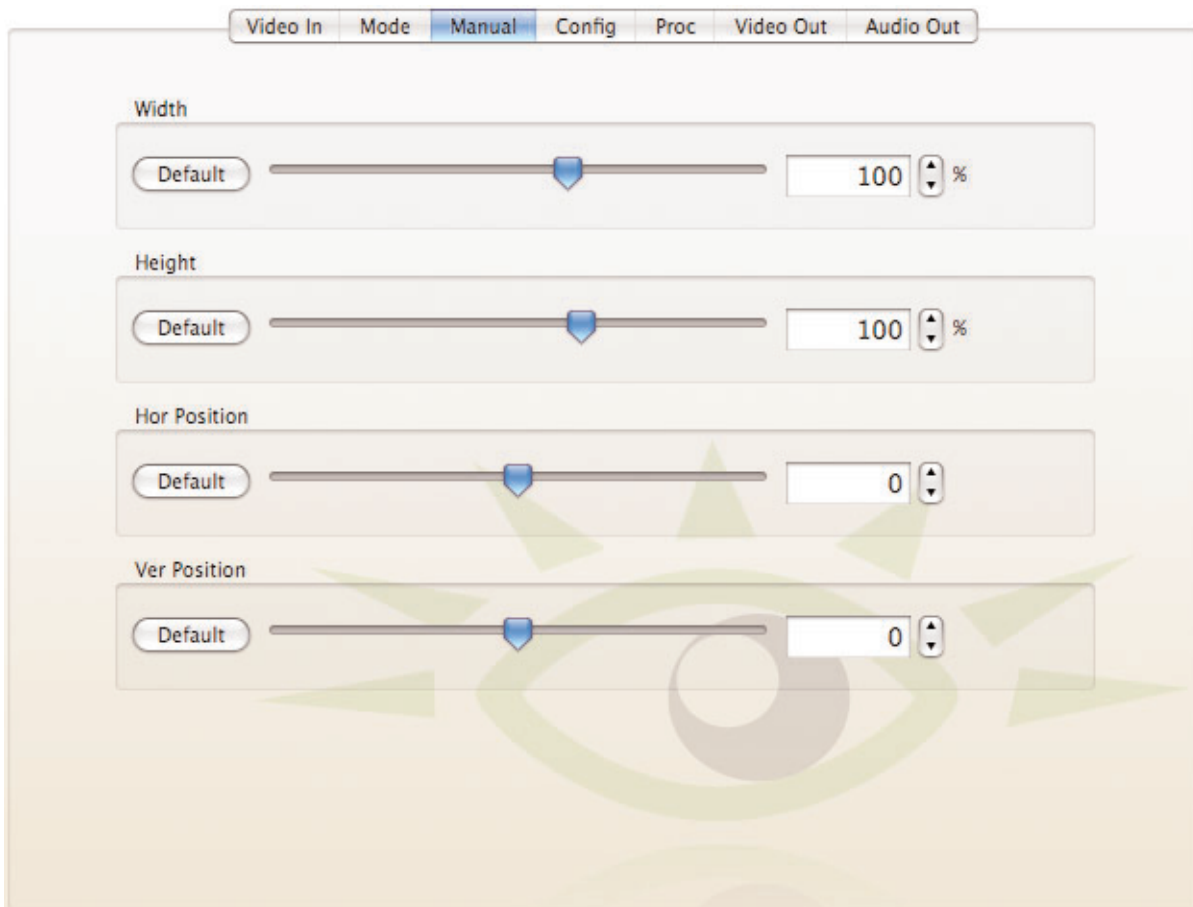

Config

- **Noise Reduce** – adjusts the amount of noise reduction on the output signal from **Off**, **Low**, **Medium**, or **High**. The typical setting for this parameter is **Off** or **Low**.
- **Detail** – adjusts the amount of picture detail enhancement on the output from **Off**, **Low**, **Medium**, or **High**. The typical setting for this parameter is **Off** or **Low**.
- **3:2 Detect** – turns the control to detect video that has been converted from film **On** or **Off**. Use this only for film applications. The typical setting for this parameter is **Off**.
- **Cpst Setup** – turns Setup on the composite output **On** or **Off** (525 only). Set this to **On** if your material has Setup on it.
- **Vert Blanking** – sets the blanking mode to **Narrow** (lines 1-9 are blanked in NTSC, lines 1-6 in PAL) or **Wide** (lines 1-20 in NTSC, lines 1-22 in PAL).
- **Output Muting** – set to either **Mute On Noise** or **Off**. **Mute On Noise** means that the module will mute the video output (output a black signal) when the module detects that the video quality is unacceptable. **Off** allows the video to pass through to the output regardless of video quality.

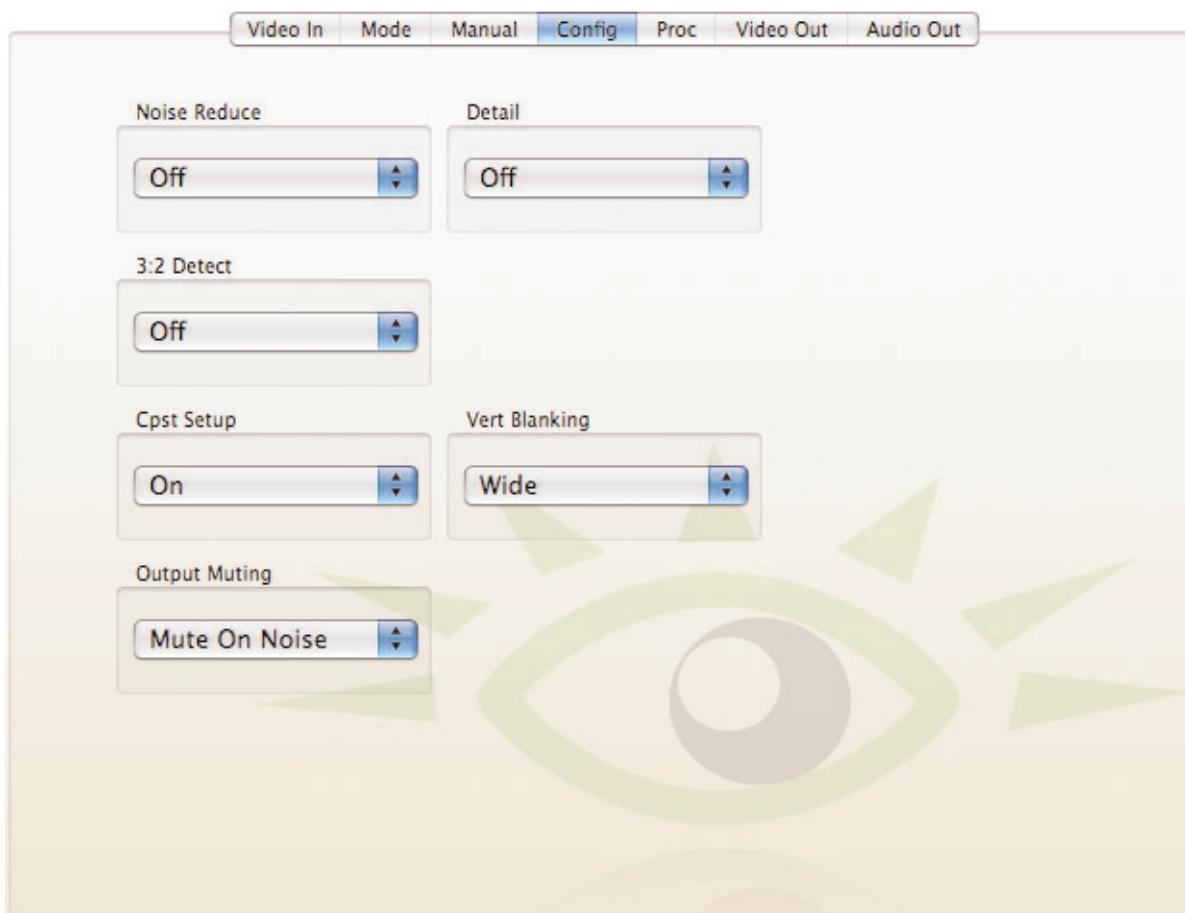

Proc

- **Gain** – adjusts the percentage of overall gain (luminance and chrominance) (range is **0** to **150%**, default is **100%**).
- **Chroma** – adjusts the percentage of chroma amplitude (range is **0** to **150%**, default is **100%**).
- **Pedestal** – adjusts the pedestal (black) level of the signal in IRE (range is **-30** to **30 IRE**, default is **0 IRE**).
- **Hue** – adjusts the hue of the signal in degrees (range is **±180 degrees**, default is **0 degrees**).

Make adjustments by clicking and dragging the slider controls, by using the up and down arrow buttons, or by entering a value directly into the field. Click the **Default** buttons to return settings to their default values.

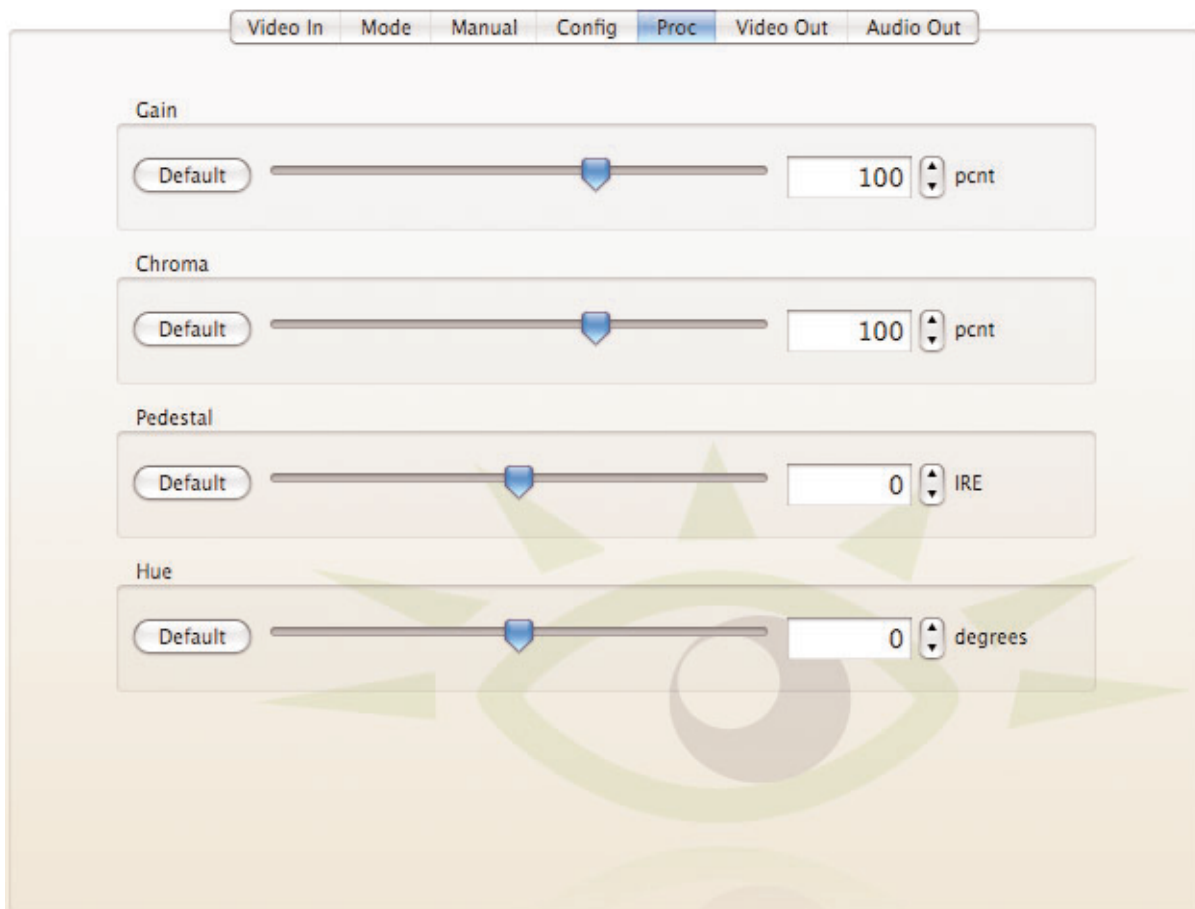





Video Out



- **Hor Timing** – use this control to adjust the horizontal timing of the output signal to place the leading edge of sync coincident with other sources (range is **-2000 to 2000 clocks**, default is **0 clocks**).
- **Vert Timing** – sets the vertical timing to a typical setting of 0 lines (range is **-1000 to 1000 lines**, default is **0 lines**).
- **Test Pattern** – select **On** or **Off**. **On** enables the test pattern to be sent to the video output. **Off** disables the test pattern from being sent to the video output.
- **HDMI Status** – reports the status of a monitor or a display connected to the HDMI output (**No Display, DVI Display, Unknown HDMI, HDMI Non-Compat, HDMI Native, HDMI Compatible**). Status information comes from the display itself. Some displays may not work with the BrightEye 92-M, depending on the formats that the display supports. For best results, use a display that is **HDMI Native**.
- **Captions Out** – use this control to enable or disable closed captioning (if present on the input source material). **On** enables closed captioning by continuously transmitting captions (including any null or empty caption packets). **Off** disables closed captioning by stripping captions from the source material. The BrightEye 92-M translates between CEA-608 and CEA-708 standards for closed captioning as needed. Note that closed captions are not supported for **1080p** and **1080sF** outputs.
- **Graticule** – use this control to display on-screen graticule lines. These alignment markers facilitate film transfer, post production and quality control measurements relating to picture location for both the 4:3 and 16:9 aspect ratios. **Safe Title** displays the safe title boxes. **SD Protect Only** displays only the SD Protect area without displaying the safe title boxes. **Off** disables graticules.
- **Target** – use this control to select the monitor on which graticule lines are displayed. Choices are **All Outputs, Main Only** (the unit's output BNCs), or **HDMI Only**.
- **Hor Flip** – Horizontal Flip is a special Mirror Output Mode that is useful for flipping the image left-to-right for use with on-screen talent or with prism lens cameras. Select **On** to flip the output image left to right. Select **Off (after Reset)** to turn Mirror Output Mode off. Power down the module and turn it back on for the **Off** selection to take effect.
- **Color** – use this control to set the color of the graticule lines. Choices are: **White, Gray, Black, Red, Blue** and **Green**.
- **Transparency** – use this control to adjust the transparency of the graticule lines from **0** (completely transparent) to **100** (no transparency).

NOTE: See Video Out diagram on next page



Video In Mode Manual Config Proc **Video Out** Audio Out



Hor Timing
Default  0  clocks

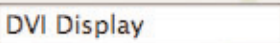

Vert Timing
Default  0  lines

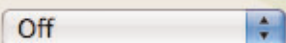

Test Pattern  Off 

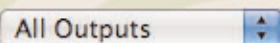

HDMI Status  DVI Display

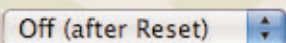

Captions Out  On 

Graticule  Off 

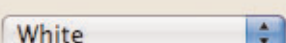
Target  All Outputs 

Hor Flip  Off (after Reset) 

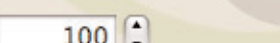
Color  White 

Transparency  100 

Audio Out

- **Mon Assign** – choose the audio pair that you want to send to the Audio Monitor headphone jack. Choices are: **Chan 1/2, Chan 3/4, Chan 5/6, Chan 7/8, Chan 9/10, Chan 11/12, Chan 13/14, Chan 15/16.**
- **Mon Volume** – sets the volume level sent to the headphone jack from 0 to 100% by moving the slider control, using the up down arrows, or entering a desired level directly in the field and pressing the **Enter** key on your computer. Press the **Default** button to return to the default setting of 100%.
- **HDMI Assign** – selects the audio pair that is output on the HDMI Out port. The HDMI port carries both audio and video signals. Choices are: **Chan 1/2, Chan 3/4, Chan 5/6, Chan 7/8, Chan 9/10, Chan 11/12, Chan 13/14, Chan 15/16.**

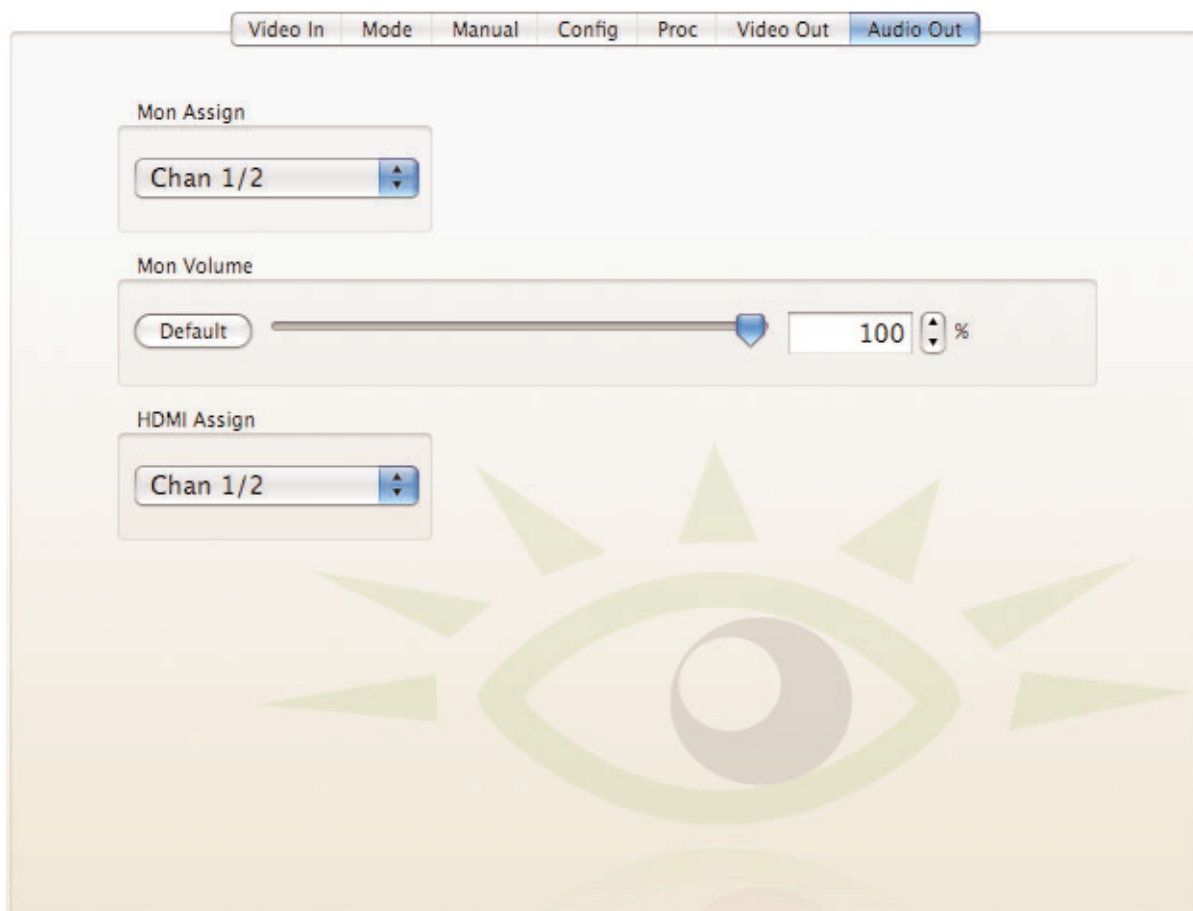

WARRANTY AND FACTORY SERVICE

Warranty

Ensemble Designs, Inc. warrants this product to be free from defect in material and workmanship for a period of five years from the date of delivery. During this five year warranty period, Ensemble Designs, Inc., will repair any defective units at Ensemble's expense if the unit should be determined to be defective after consultation with a factory technician.

This warranty is not transferable. Any implied warranties expire at the expiration date of this warranty.

This warranty does not cover a defect that has resulted from improper or unreasonable use or maintenance as determined by us. This warranty is void if there is any attempt to disassemble or adjust factory set presets without factory authorization.

 Illuminates green when power is applied to the unit and the internal voltage regulator is functioning correctly.

Factory Service

If you require service (under warranty or not), please contact Ensemble Designs and ask for Customer Service before you return the unit. This will allow the service technician to provide any other suggestions for identifying the problem and recommend possible solutions.

You may also refer to the technical support section of the Ensemble web site for the latest information on your equipment at the URL below:

<http://www.ensembledesigns.com/support>

If you return equipment for repair, please get a Return Material Authorization Number (RMA) from the factory first.

Ship the product and a written description of the problem to:

Ensemble Designs, Inc.
Attention: Customer Service RMA #####
870 Gold Flat Rd.
Nevada City, CA 95959 USA
(530) 478-1830
Fax: (530) 478-1832
service@ensembledesigns.com
<http://www.ensembledesigns.com>

Be sure to put your RMA number on the outside of the box.

Specifications

Serial Digital Input

Number	One
Signal Type	HD Serial Digital 1.485 Gb/s SMPTE 274M, 292M, 296M
Impedance	75 Ω
Return Loss	>15dB
Max Cable Length	100 meters for 1.485Gb/s HD
Automatic Input Cable Equalization	

Reference Input

Number	One
Type	1 V P-P Composite Video PAL or NTSC or Tri-Level Sync
Impedance	75 Ω
Return Loss	>40 dB

Analog Video Output

Number	One
Type	Composite PAL or NTSC
Delay	Adjustable from 1 field to 1 frame
Return Loss	>40 dB
Output	DC < 100 mV

Serial Digital Output

Number	Two
Type	SD Serial Digital 270Mb/s SMPTE 259M
Delay	Adjustable from 1 field to 1 frame
Processing	12 and 16 bit
Impedance	75 Ω
Return Loss	>15 dB
Max Cable Length	300 meters for 270 Mb/s SD (Belden 1694A)

HD Standards Supported

1080i 50,59.94 or 60 Hz SMPTE 274M -4,5,6
720p 50,59.94 or 60 Hz SMPTE 296M -1,2,3
1080p 23.98,24 or 25 Hz SMPTE 274M -9,10,11
1080sF 23.98,24 or 25 Hz RP211 -14,15,16

Monitor Output

Number	One
Connector	HDMI
Type	Follows SDI out

Audio Monitoring Output

Number	One (for monitoring a pair of audio channels)
Connector	3.5mm stereo mini jack

General Specifications

Size	5.625" W x 1.7" H x 5.5" D (143 mm x 40 mm x 140 mm) including connectors
Weight	1 lb 7 oz
Power	12 volts, 10 watts (100-230 VAC modular power supply not included)
Temperature Range	0 to 40° C ambient
Relative Humidity	0 to 95° noncondensing

Due to ongoing product development, all specifications subject to change.

BRIGHTEYE POWER SUPPLY INFORMATION

Below is a list of power supplies and optional items that may have come with your BrightEye.

BEPS

BrightEye Individual Power Supply.

BEPS6

Spider Power Supply. This powers 6 single high BrightEyes or 3 double high BrightEyes.

BEPS6-RP

Redundant Power Supply for Spider.

BERKMT

BrightEye Rack Mount. This holds 6 single high BrightEyes or 3 double high BrightEyes, or a combination.

BEBP

BrightEye Blank Panel. Single high, for empty slots in Rack Mount.

BEAC

Analog Audio Breakout Cable.

GLOSSARY

AES/EBU

The digital audio standard defined as a joint effort of the Audio Engineering Society and the European Broadcast Union. AES/EBU or AES3 describes a serial bitstream that carries two audio channels, thus an AES stream is a stereo pair. The AES/EBU standard covers a wide range of sample rates and quantizations (bit depths). In television systems, these will generally be 48 KHz and either 20 or 24 bits.

AFD

Active Format Description is a method to carry information regarding the aspect ratio of the video content. The specification of AFD was standardized by SMPTE in 2007 and is now beginning to appear in the marketplace. AFD can be included in both SD and HD SDI transport systems. There is no legacy analog implementation. (See WSS).

ASI

A commonly used transport method for MPEG video streams, ASI or Asynchronous Serial Interface, operates at the same 270 Mb/s data rate as SD SDI. This makes it easy to carry an ASI stream through existing digital television infrastructure. Known more formally as DVB-ASI, this transport mechanism can be used to carry multiple program channels.

Aspect Ratio

The ratio of the vertical and horizontal measurements of an image. 4:3 is the aspect ratio for standard definition video formats and television and 16:9 for high definition. Converting formats of unequal ratios is done by letterboxing (horizontal bars) or pillar boxing (vertical pillars) in order to keep the original format's aspect ratio.

Bandwidth

Strictly speaking, this refers to the range of frequencies (i.e. the width of the band of frequency) used by a signal, or carried by a transmission channel. Generally, wider bandwidth will carry and reproduce a signal with greater fidelity and accuracy.

Beta

Sony Beta SP video tape machines use an analog component format that is similar to SMPTE, but differs in the amplitude of the color difference signals. It may also carry setup on the luminance channel.

Bit

A binary digit, or bit, is the smallest amount of information that can be stored or transmitted digitally by electrical, optical, magnetic, or other means. A single bit can take on one of two states: On/Off, Low/High, Asserted/ Deasserted, etc. It is represented numerically by the numerals 1 (one) and 0 (zero). A byte, containing 8 bits, can represent 256 different states. The binary number 11010111, for example, has the value of 215 in our base 10 numbering system. When a value is carried digitally, each additional bit of resolution will double the number of different states that can be represented. Systems that operate with a greater

number of bits of resolution, or quantization, will be able to capture a signal with more detail or fidelity. Thus, a video digitizer with 12 bits of resolution will capture 4 times as much detail as one with 10 bits.

Blanking

The Horizontal and Vertical blanking intervals of a television signal refer to the time periods between lines and between fields. No picture information is transmitted during these times, which are required in CRT displays to allow the electron beam to be repositioned for the start of the next line or field. They are also used to carry synchronizing pulses which are used in transmission and recovery of the image. Although some of these needs are disappearing, the intervals themselves are retained for compatibility purposes. They have turned out to be very useful for the transmission of additional content, such as teletext and embedded audio.

CAV

Component Analog Video. This is a convenient shorthand form, but it is subject to confusion. It is sometimes used to mean ONLY color difference component formats (SMPTE or Beta), and other times to include RGB format. In any case, a CAV signal will always require 3 connectors – either Y/R-Y/B-Y, or R/G/B.

Checkfield

A Checkfield signal is a special test signal that stresses particular aspects of serial digital transmission. The performance of the Phase Locked-Loops (PLLs) in an SDI receiver must be able to tolerate long runs of 0's and 1's. Under normal conditions, only very short runs of these are produced due to a scrambling algorithm that is used. The Checkfield, also referred to as the Pathological test signal, will “undo” the scrambling and cause extremely long runs to occur. This test signal is very useful for testing transmission paths.

Chroma

The color or chroma content of a signal, consisting of the hue and saturation of the image. See also Color Difference.

Component

In a component video system, the totality of the image is carried by three separate but related components. This method provides the best image fidelity with the fewest artifacts, but it requires three independent transmission paths (cables). The commonly used component formats are Luminance and Color Difference (Y/Pr/Pb), and RGB. It was far too unwieldy in the early days of color television to even consider component transmission.

Composite

Composite television dates back to the early days of color transmission. This scheme encodes the color difference information onto a color subcarrier. The instantaneous phase of the subcarrier is the color's hue, and the amplitude is the color's saturation or intensity. This subcarrier is then added onto the existing luminance video signal. This trick works because the subcarrier is set at a high enough frequency to leave spectrum for the luminance information. But it is not a seamless matter to pull the signal apart again at the destination in order to display it or process it. The resultant artifacts of dot crawl (also referred to as chroma crawl) are only the most obvious result. Composite television is the most

commonly used format throughout the world, either as PAL or NTSC. It is also referred to as Encoded video.

Color Difference

Color Difference systems take advantage of the details of human vision. We have more acuity in our black and white vision than we do in color. This means that we need only the luminance information to be carried at full bandwidth, we can scrimp on the color channels. In order to do this, RGB information is converted to carry all of the luminance (Y is the black and white of the scene) in a single channel. The other two channels are used to carry the “color difference”. Noted as B-Y and R-Y, these two signals describe how a particular pixel “differs” from being purely black and white. These channels typically have only half the bandwidth of the luminance.

Decibel (dB)

The decibel is a unit of measure used to express the ratio in the amplitude or power of two signals. A difference of 20 dB corresponds to a 10:1 ratio between two signals, 6 dB is approximately a 2:1 ratio. Decibels add while the ratios multiply, so 26 dB is a 20:1 ratio, and 14 dB is a 5:1 ratio. There are several special cases of the dB scale, where the reference is implied. Thus, dBm refers to power relative to 1 milliwatt, and dBu refers to voltage relative to .775V RMS. The original unit of measure was the Bel (10 times bigger), named after Alexander Graham Bell.

dBFS

In Digital Audio systems, the largest numerical value that can be represented is referred to as Full Scale. No values or audio levels greater than FS can be reproduced because they would be clipped. The nominal operating point (roughly corresponding to 0 VU) must be set below FS in order to have headroom for audio peaks. This operating point is described relative to FS, so a digital reference level of -20 dBFS has 20 dB of headroom before hitting the FS clipping point.

DVI

Digital Visual Interface. DVI-I (integrated) provides both digital and analog connectivity. The larger group of pins on the connector are digital while the four pins on the right are analog.

EDH

Error Detection and Handling is a method to verify proper reception of an SDI or HD-SDI signal at the destination. The originating device inserts a data packet in the vertical interval of the SDI signal and every line of the HD signal which contains a checksum of the entire video frame. This checksum is formed by adding up the numerical values of all of the samples in the frame, using a complex formula. At the destination this same formula is applied to the incoming video and the resulting value is compared to the one included in the transmission. If they match, then the content has all arrived with no errors. If they don't, then an error has occurred.

Embedded Audio

Digital Audio can be carried along in the same bitstream as an SDI or HD-SDI signal by taking advantage of the gaps in the transmission which correspond to the horizontal and vertical intervals of the television waveform. This technique

can be very cost effective in transmission and routing, but can also add complexity to signal handling issues because the audio content can no longer be treated independently of the video.

Eye Pattern

To analyze a digital bitstream, the signal can be displayed visually on an oscilloscope by triggering the horizontal timebase with a clock extracted from the stream. Since the bit positions in the stream form a very regular cadence, the resulting display will look like an eye – an oval with slightly pointed left and right ends. It is easy to see from this display if the eye is "open", with a large central area that is free of negative or positive transitions, or "closed" where those transitions are encroaching toward the center. In the first case, the open eye indicates that recovery of data from the stream can be made reliably and with few errors. But in the closed case data will be difficult to extract and bit errors will occur. Generally it is jitter in the signal that is the enemy of the eye.

Frame Sync

A Frame Synchronizer is used to synchronize the timing of a video signal to coincide with a timing reference (usually a color black signal that is distributed throughout a facility). The synchronizer accomplishes this by writing the incoming video into a frame buffer memory under the timing direction of the sync information contained in that video. Simultaneously the memory is being read back by a timing system that is genlocked to a house reference. As a result, the timing or alignment of the video frame can be adjusted so that the scan of the upper left corner of the image is happening simultaneously on all sources. This is a requirement for both analog and digital systems in order to perform video effects or switch glitch-free in a router. Frame synchronization can only be performed within a single television line standard. A synchronizer will not convert an NTSC signal to a PAL signal, it takes a standards converter to do that.

Frequency Response

A measurement of the accuracy of a system to carry or reproduce a range of signal frequencies. Similar to Bandwidth.

H.264

The latest salvo in the compression wars is H.264 which is also known as MPEG-4 Part 10. MPEG-4 promises good results at just half the bit rate required by MPEG-2.

HD

High Definition. This two letter acronym has certainly become very popular. Here we thought it was all about the pictures – and the radio industry stole it.

HDMI

The High Definition Multimedia Interface comes to us from the consumer marketplace where it is becoming the de facto standard for the digital interconnect of display devices to audio and video sources. It is an uncompressed, all-digital interface that transmits digital video and eight channels of digital audio. HDMI is a bit serial interface that carries the video content in digital component form over multiple twisted-pairs. HDMI is closely related to the DVI interface for desktop computers and their displays.

IEC

The International Electrotechnical Commission provides a wide range of worldwide standards. They have provided standardization of the AC power connection to products by means of an IEC line cord. The connection point uses three flat contact blades in a triangular arrangement, set in a rectangular connector. The IEC specification does not dictate line voltage or frequency. Therefore, the user must take care to verify that a device either has a universal input (capable of 90 to 230 volts, either 50 or 60 Hz), or that a line voltage switch, if present, is set correctly.

Interlace

Human vision can be fooled to see motion by presenting a series of images, each with a small change relative to the previous image. In order to eliminate the flicker, our eyes need to see more than 30 images per second. This is accomplished in television systems by dividing the lines that make up each video frame (which run at 25 or 30 frames per second) into two fields. All of the odd-numbered lines are transmitted in the first field, the even-numbered lines are in the second field. In this way, the repetition rate is 50 or 60 Hz, without using more bandwidth. This trick has worked well for years, but it introduces other temporal artifacts. Motion pictures use a slightly different technique to raise the repetition rate from the original 24 frames that make up each second of film—they just project each one twice.

IRE

Video level is measured on the IRE scale, where 0 IRE is black, and 100 IRE is full white. The actual voltages that these levels correspond to can vary between formats.

ITU-R 601

This is the principal standard for standard definition component digital video. It defines the luminance and color difference coding system that is also referred to as 4:2:2. The standard applies to both PAL and NTSC derived signals. They both will result in an image that contains 720 pixels horizontally, with 486 vertical pixels in NTSC, and 576 vertically in PAL. Both systems use a sample clock rate of 27 Mhz, and are serialized at 270 Mb/s.

Jitter

Serial digital signals (either video or audio) are subject to the effects of jitter. This refers to the instantaneous error that can occur from one bit to the next in the exact position of each digital transition. Although the signal may be at the correct frequency on average, in the interim it varies. Some bits come slightly early, others come slightly late. The measurement of this jitter is given either as the amount of time uncertainty or as the fraction of a bit width. For 270 Mb/s SD video, the allowable jitter is 740 picoseconds, or 0.2 UI (Unit Interval – one bit width). For 1.485 Gb/s HD, the same 0.2UI spec corresponds to just 135 pico seconds.

Luminance

The “black & white” content of the image. Human vision had more acuity in luminance, so television systems generally devote more bandwidth to the luminance content. In component systems, the luminance is referred to as Y.

MPEG

The Moving Picture Experts Group is an industry group that develops standards for the compression of moving pictures for television. Their work is an on-going effort. The understanding of image processing and information theory is constantly expanding. And the raw bandwidth of both the hardware and software used for this work is ever increasing. Accordingly, the compression methods available today are far superior to the algorithms that originally made the real-time compression and decompression of television possible. Today, there are many variations of these techniques, and the term MPEG has to some extent become a broad generic label.

Metadata

This word comes from the Greek, meta means 'beyond' or 'after'. When used as a prefix to 'data', it can be thought of as 'data about the data'. In other words, the metadata in a data stream tells you about that data – but it is not the data itself. In the television industry, this word is sometimes used correctly when, for example, we label as metadata the timecode which accompanies a video signal. That timecode tells you something about the video, i.e. when it was shot, but the timecode in and of itself is of no interest. But in our industry's usual slovenly way in matters linguistic, the term metadata has also come to be used to describe data that is associated with the primary video in a datastream. So embedded audio will (incorrectly) be called metadata when it tells us nothing at all about the pictures. Oh well.

Multi-mode

Multi-mode fibers have a larger diameter core than single mode fibers (either 50 or 62.5 microns compared to 9 microns), and a correspondingly larger aperture. It is much easier to couple light energy into a multi-mode fiber, but internal reflections will cause multiple “modes” of the signal to propagate down the fiber. This will degrade the ability of the fiber to be used over long distances. See also Single Mode.

NTSC

The color television encoding system used in North America was originally defined by the National Television Standards Committee. This American standard has also been adopted by Canada, Mexico, Japan, Korea, and Taiwan. (This standard is referred to disparagingly as Never Twice Same Color.)

Optical

An optical interface between two devices carries data by modulating a light source. This light source is typically a laser or laser diode (similar to an LED) which is turned on and off at the bitrate of the datastream. The light is carried from one device to another through a glass fiber. The fiber's core acts as a waveguide or lightpipe to carry the light energy from one end to another. Optical transmission has two very significant advantages over metallic copper cables. Firstly, it does not require that the two endpoint devices have any electrical connection to each other. This can be very advantageous in large facilities where problems with ground loops appear. And secondly, and most importantly, an optical interface can carry a signal for many kilometers or miles without any degradation or loss in the recovered signal. Copper is barely useful at distances of just 1000 feet.

Oversampling

A technique to perform digital sampling at a multiple of the required sample rate. This has the advantage of raising the Nyquist Rate (the maximum frequency which can be reproduced by a given sample rate) much higher than the desired passband. This allows more easily realized anti-aliasing filters.

PAL

During the early days of color television in North America, European broadcasters developed a competing system called Phase Alternation by Line. This slightly more complex system is better able to withstand the differential gain and phase errors that appear in amplifiers and transmission systems. Engineers at the BBC claim that it stands for Perfection At Last.

Pathological Test Pattern – see Checkfield

Progressive

An image scanning technique which progresses through all of the lines in a frame in a single pass. Computer monitors all use progressive displays. This contrasts to the interlace technique common to television systems.

Return Loss

An idealized input or output circuit will exactly match its desired impedance (generally 75 ohms) as a purely resistive element, with no reactive (capacitive or inductive) elements. In the real world, we can only approach the ideal. So, our real inputs and outputs

will have some capacitance and inductance. This will create impedance matching errors, especially at higher frequencies. The Return Loss of an input or output measures how much energy is returned (reflected back due to the impedance mismatch). For digital circuits, a return loss of 15 dB is typical. This means that the energy returned is 15 dB less than the original signal. In analog circuits, a 40 dB figure is expected.

RGB

RGB systems carry the totality of the picture information as independent Red, Green, and Blue signals. Television is an additive color system, where all three components add to produce white. Because the luminance (or detail) information is carried partially in each of the RGB channels, all three must be carried at full bandwidth in order to faithfully reproduce an image.

ScH Phase

Used in composite systems, ScH Phase measures the relative phase between the leading edge of sync on line 1 of field 1 and a continuous subcarrier sinewave. Due to the arithmetic details of both PAL and NTSC, this relationship is not the same at the beginning of each frame. In PAL, the pattern repeats every 4 frames (8 fields) which is also known as the Bruch Blanking sequence. In NTSC, the repeat is every 2 frames (4 fields). This creates enormous headaches in editing systems and the system timing of analog composite facilities.

SDI

Serial Digital Interface. This term refers to inputs and outputs of devices that support serial digital component

video. This could refer to standard definition at 270 Mb/s, HD SDI or High Definition Serial Digital video at 1.485 Gb/s, or to the newer 3G standard of High Definition video at 2.97 Gb/s.

SMPTE

The Society of Motion Picture and Television Engineers is a professional organization which has done tremendous work in setting standards for both the film and television industries. The term "SMPTE" is also shorthand for one particular component video format - luminance and color difference.

Single Mode

A Single mode (or mono mode) optical fiber carries an optical signal on a very small diameter (9 micron) core surrounded with cladding. The small diameter means that no internally reflected lightwaves will be propagated. Thus only the original "mode" of the signal passes down the fiber. A single mode fiber used in an optical SDI system can carry a signal for up to 20 kilometers. Single mode fibers require particular care in their installation due to the extremely small optical aperture that they present at splice and connection points.

See also Multi-mode.

TBC

A Time Base Corrector is a system to reduce the Time Base Error in a signal to acceptable levels. It accomplishes this by using a FIFO (First In, First Out) memory. The incoming video is written into the memory using its own jittery timing. This operation is closely associated with the actual digitization of the analog signal because the varying position of the sync timing must be mimicked by the sampling function of the analog to digital converter. A second timing system, genlocked to a stable reference, is used to read the video back out of the memory. The memory acts as a dynamically adjusting delay to smooth out the imperfections in the original signal's timing. Very often a TBC will also function as a Frame Synchronizer. See also Frame Sync.

Time Base Error

Time base error is present when there is excessive jitter or uncertainty in the line to line output timing of a video signal. This is commonly associated with playback from video tape recorders, and is particularly severe with consumer type heterodyne systems like VHS. Time base error will render a signal unusable for broadcast or editing purposes.

Timecode

Timecode, a method to uniquely identify and label every frame in a video stream, has become one of the most recognized standards ever developed by SMPTE. It uses a 24 hour clock, consisting of hours, minutes, seconds, and television frames. Originally recorded on a spare audio track, this 2400 baud signal was a significant contributor to the development of video tape editing. We now refer to this as LTC or Longitudinal Time Code because it was carried along the edge of the tape. This allowed it to be recovered in rewind and fast forward when the picture itself could not. Timecode continues to be useful today and is carried in the vertical interval as VITC, and as a digital packet as DVITC. Timecode is the true metadata.

Tri-Level Sync

For many, many years, television systems used composite black as a genlock reference source. This was a natural evolution from analog systems to digital implementations. With the advent of High Definition television, with even higher data rates and tighter jitter requirements, problems with this legacy genlock signal surfaced. Further, a reference signal with a 50 or 60 Hz frame rate was useless with 24 Hz HD systems running at film rates. Today we can think of composite black as a bi-level sync signal – it has two levels, one at sync tip and one at blanking. For HD systems, Tri-Level Sync, which has the same blanking level (at ground) of bi-level sync, but the sync pulse now has both a negative and a positive element. This keeps the signal symmetrically balanced so that its DC content is zero. And it also means that the timing pickoff point is now at the point where the signal crosses blanking and is no longer subject to variation with amplitude. This makes Tri-Level Sync a much more robust signal and one which can be delivered with less jitter.

USB

The Universal Serial Bus, developed in the computer industry to replace the previously ubiquitous RS-232 serial interface, now appears in many different forms and with many different uses. It actually forms a small local area network, allowing multiple devices to coexist on a single bus where they can be individually addressed and accessed.

VGA

Video Graphics Array. Traditional 15-pin, analog interface between a PC and monitor.

Word Clock

Use of Word Clock to genlock digital audio devices developed in the audio recording industry. Early digital audio products were interconnected with a massive parallel connector carrying a twisted pair for every bit in the digital audio word. A clock signal, which is a square wave at the audio sampling frequency, is carried on a 75 ohm coaxial cable. Early systems would daisychain this 44.1 or 48 kilohertz clock from one device to another with coax cable and Tee connectors. On the rising edge of this Word Clock these twisted pairs would carry the left channel, while on the falling edge, they would carry the right channel. In most television systems using digital audio, the audio sample clock frequency (and hence the 'genlock' between the audio and video worlds) is derived from the video genlock signal. But products that are purely audio, with no video reference capability, may still require Word Clock.

WSS

Wide Screen Signaling is used in the PAL/625 video standards, both in analog and digital form, to convey information about the aspect ratio and format of the transmitted signal. Carried in the vertical interval, much like closed captioning, it can be used to signal a television receiver to adjust its vertical or horizontal sizing to reflect incoming material. Although an NTSC specification for WSS exists, it never achieved any traction in the marketplace.

YUV

Strictly speaking, YUV does not apply to component video. The letters refer to the Luminance (Y), and the U and V encoding axes using in the PAL composite system. Since the U axis is very close to the B-Y axis, and the V axis is very close to the R-Y axis, YUV is often used as a sort of shorthand for the more long-winded “Y/R-Y/B-Y”.

Y/Cr/Cb

In digital component video, the luminance component is Y, and the two color difference signals are Cr (R-Y) and Cb (B-Y).

Y/Pr/Pb

In analog component video, the image is carried in three components. The luminance is Y, the R-Y color difference signal is Pr, and the B-Y color difference signal is Pb.