



BrightEye *Mitto*[™]

**DVI/VGA to
3G/Fiber/HD/SD
Scan Converter
User Guide**

ENSEMBLE

D E S I G N S

Revision 1.3 SW v1.0.0

Contents

PRODUCT OVERVIEW	5
Digital and Analog Video and Audio	7
Easy to Use	7
Free Software Upgrades	7
FUNCTIONAL DESCRIPTION	8
Video	8
Audio	8
RS-232 and GPI Control	9
BLOCK DIAGRAM	10
APPLICATIONS	12
Getting Started	12
Installing BrightEye Software	12
Connecting Mitto	13
Configuring Mitto and Your Computer Monitor Resolution	14
When using VGA	16
Verifying Resolution Settings for PC and Mac	16
EDID	16
REAR CONNECTORS	17
RS-232 / GPI	18
Audio/Digital Audio In	18
SDI Out 1 and 2	19
Composite Out	19
Ref In (Reference In)	19
Power Connection	20
USB Connector	20
DVI/VGA Input	21

DVI/VGA Loop Out	21
CONFIGURATION AND CONTROL	22
Adjusting Parameters from the Front Panel	22
Resetting to Default Values	22
Press and Hold to Accelerate Movement Controls	22
Front Panel Controls and Indicators	23
Status Indicators	23
USING THE BRIGHT EYE CONTROL APPLICATION	24
Software version requirement	24
Configuration and Setup	25
Output Menu	25
Audio Configuration Menu	27
Input Menu	29
Position Menu	30
Selection Tool	33
Mixer Menu	36
Proc Menu	37
Timing Menu	38
Memory Menu	39
TROUBLESHOOTING	40
There is no output signal, and/or the selection tool is not behaving as expected	40
Aspect ratio is not being maintained correctly	40
Mitto reports a different resolution than the settings you have applied to your computer	40
I do not understand how to configure Mitto to work with a laptop	41
BrightEye Mitto is not converting VGA to DVI	41
Using monitors that have HDMI input instead of DVI input with Mitto	41
SOFTWARE UPDATING	42

WARRANTY AND FACTORY SERVICE	42
Warranty	42
Factory Service	42
SPECIFICATIONS	43
GLOSSARY	46

PRODUCT OVERVIEW

BrightEye Mitto™ family of high performance scan converters converts DVI or VGA to SD, HD, 3 Gb/s and composite video. There are four models with various capabilities. This manual covers the BrightEye Mitto 3G Scan Converter.

For broadcasters and video professionals who rely on video content from the web, BrightEye Mitto™ offers the best way to take computer video to air. Mitto provides a way to use YouTube™ material in a news broadcast, show financial data from a web site on a TV program, display viewer emails on a morning talk show, or take radar information from a computer into a master control switcher for on-air use.

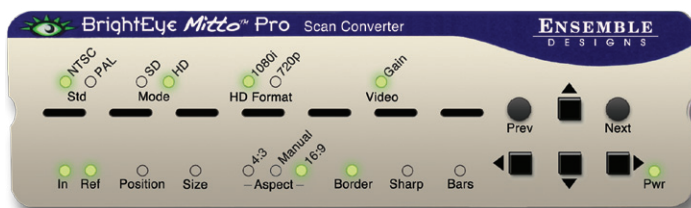
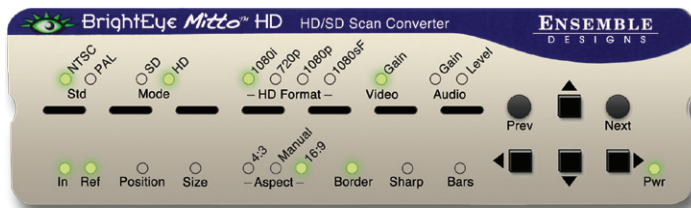
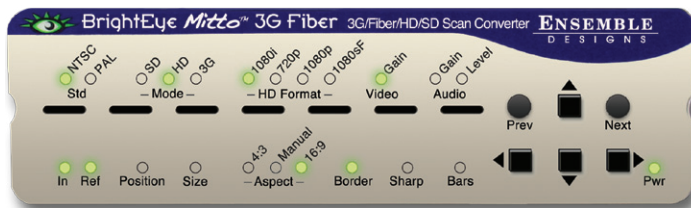
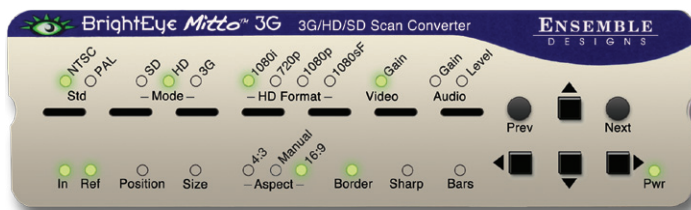

Four Different BrightEye Mitto Models

- BEM-1 BrightEye Mitto 3G
- BEM-1F BrightEye Mitto 3G Fiber
- BEM-2 BrightEye Mitto HD
- BEM-3 BrightEye Mitto Pro

Comes with 1 USB cable, 2 VGA to DVI adapters and BrightEye Software for Mac and PC.

	BrightEye Mitto 3G BEM-1	BrightEye Mitto 3G Fiber BEM-1F	BrightEye Mitto HD BEM-2	BrightEye Mitto Pro BEM-3
DVI, VGA, or HDMI inputs	✦	✦	✦	✦
HD or SD video outputs	✦	✦	✦	✦
3 Gb/s video output	✦	✦		
Optical output		✦		
Analog or embedded audio input	✦	✦	✦	✦
AES audio input and output	✦	✦	✦	
Full control of audio levels, channel mixing	✦	✦	✦	
Adjustable audio delay	✦	✦	✦	
RS-232/GPI control	✦	✦	✦	

Exclusive Filtering and Scaling Technology

A superior quality scan converter, BrightEye Mitto™ has the advantage of proprietary scaling technology and exclusive multi-tap filtering. The region you select for output determines if Mitto acts as an upconverter or downconverter. The filters automatically adjust according to the conversion being performed.

Bringing progressive images from the desktop into the interlaced world of video used to be a compromise between sharp details versus interfield flicker. Mitto's advanced filtering satisfies both of these requirements. The result is that the output looks as good, or better, than the original and passes the most stringent testing.

Digital and Analog Video and Audio

The intuitive front panel interface makes it easy to choose the desired video output format. Choices are 1.5 and 3 Gb/s HD SDI and SD SDI. When the digital output is SD SDI, analog composite video is output on a separate BNC. The genlock reference input allows the video output to be timed to house.

The audio input accepts either AES digital audio or analog audio. Audio is embedded into the SDI outputs which is useful for integration with video servers and routers.

Easy to Use

BrightEye Mitto™ is easy to use, both from the software interface and the front panel. All the control you need is available from the front panel. Screen selection, video format, timing and many of the other controls can be accessed with push buttons from the Mitto front panel.

The included BrightEye Mac/PC control application provides an additional level of control. It allows you to use your mouse to click and drag over the specific portion of computer video that you want to output. This lets you see the parts of the screen you don't want to output, as well as the parts you do want to use. The perspective of seeing the whole screen gives you the ability to choose exactly which portion of the video you want to output. Whether you output the entire screen or just a selected portion, you will be able to see exactly what you are doing. Presets enable you to store your favorite settings. The BrightEye Mac/PC control software is not required, but it does offer a very handy user-interface.

Free Software Upgrades

BrightEye Mitto's software is easily upgraded through the unit's USB port. Software upgrades are available for no charge for the life of the product and are conveniently downloadable from the Ensemble Designs web site.

Every unit comes with a five-year warranty.

FUNCTIONAL DESCRIPTION

Video

The BrightEye Mitto™ is a scan converter with a DVI/VGA input. Its output options are SD (standard definition), HD (high definition), and 3G (high definition).

In a typical application, Mitto sits between the computer and the computer monitor. The computer feeds the DVI-I input. The Mitto DVI-I Loop Out feeds the computer monitor. The maximum resolution supported is 1920 by 1200 which is excellent for HD applications.

Mitto's DVI/VGA Input and the DVI/VGA Loop Out use DVI-I (integrated) connectors which provide both digital and analog connectivity. The larger group of pins are digital while the four pins on the right are analog. Included with every Mitto are two 15-pin, VGA-to-DVI adapters for use in legacy installations.

SDI Out 1 and 2 BNCs output SD SDI, 1.5 Gb/s HD SDI, or 3 Gb/s HD SDI video. The output only includes the portion of the computer screen that you have selected with Mitto. Mitto upconverts or downconverts the signal depending on how much of the computer video you select and the output standard you select.

The Composite Out BNC provides composite video out when SD is selected on the SDI outputs. If HD is selected on the SDI outputs then the composite out BNC outputs black. Alternately, the Composite Out BNC can be set to output AES audio with a control in BrightEye PC/Mac software.

Audio

Mitto has four audio sources to draw from: analog audio in, AES audio in, audio coming in along with an HDMI input, and an internal tone generator.

AES digital audio or analog audio can be fed from the computer's headphone out or line out into Mitto's audio input. The audio input is an 1/8 inch stereo mini-jack that goes to a stereo analog-to-digital converter with two AES receivers which are followed by two sample rate converters. Two channels of analog audio or four channels (two streams) of AES digital audio are supported on this input.

If an HDMI input is used, 8 channels of embedded audio may be present.

There is also a tone generator. When Mitto's internal color bars are turned on, there will be bars and tone on the output.

The built-in audio mixer provides for level adjustment, channel tie, and output assignment controls for up to four channels of output. If you use the audio control on Mitto's front panel, the slider controls will automatically tie together.

The audio appears in the embedded SDI outputs and, if desired, can also be output as AES on the Composite Out BNC.

RS-232 and GPI Control

Mitto's RS -232/GPI port can be used with third-party control and automation systems. GPI and RS-232 are supported simultaneously. Additionally, the Ensemble Designs Avenue GPI control panel (part number XYCP) can be used with BrightEye Mitto™.

BLOCK DIAGRAM

For your reference, see the functional block diagram on this page and the following page. The diagram appears twice, first in a portrait view, then larger as a landscape view.

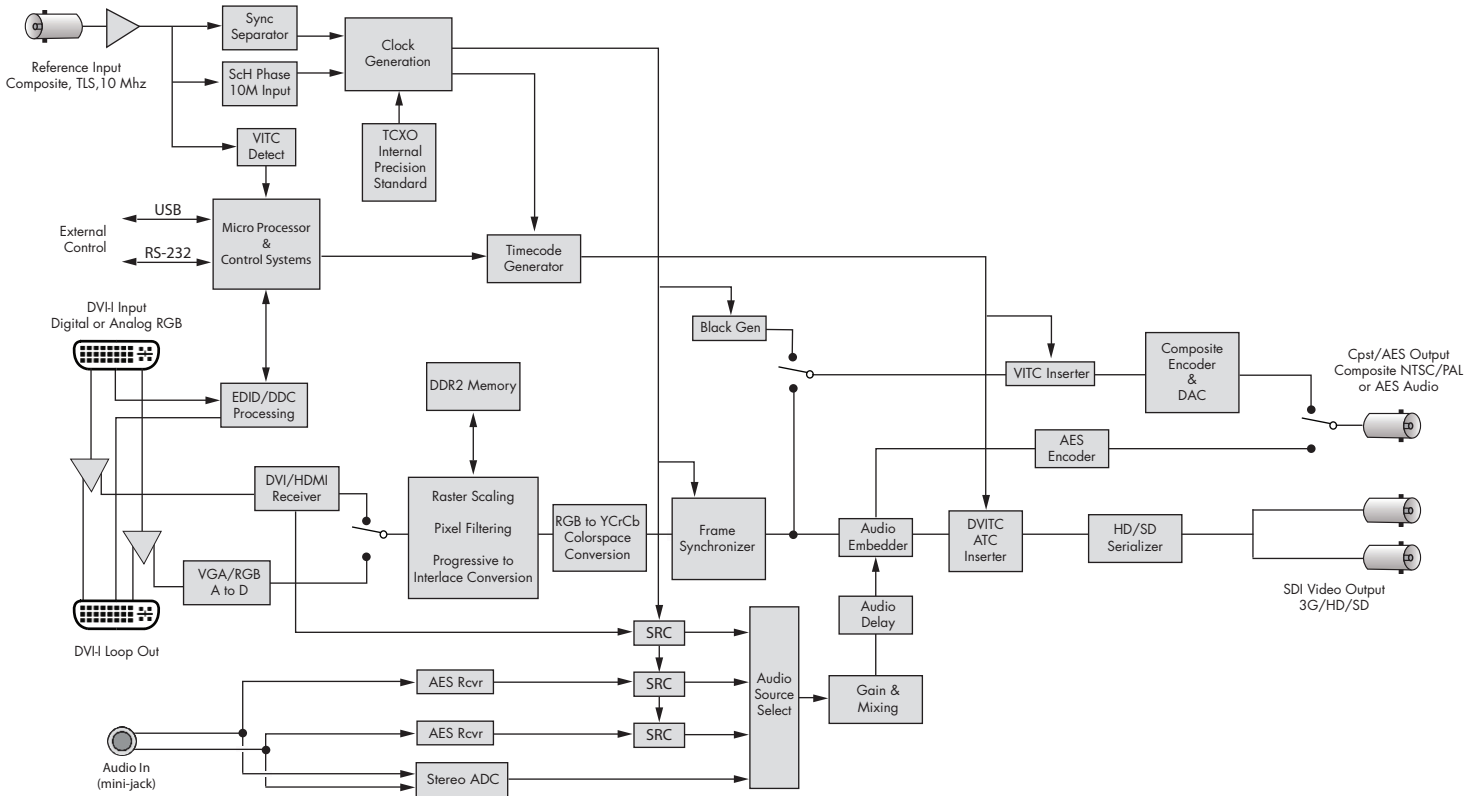

BrightEye Mitto Functional Block Diagram, Portrait View

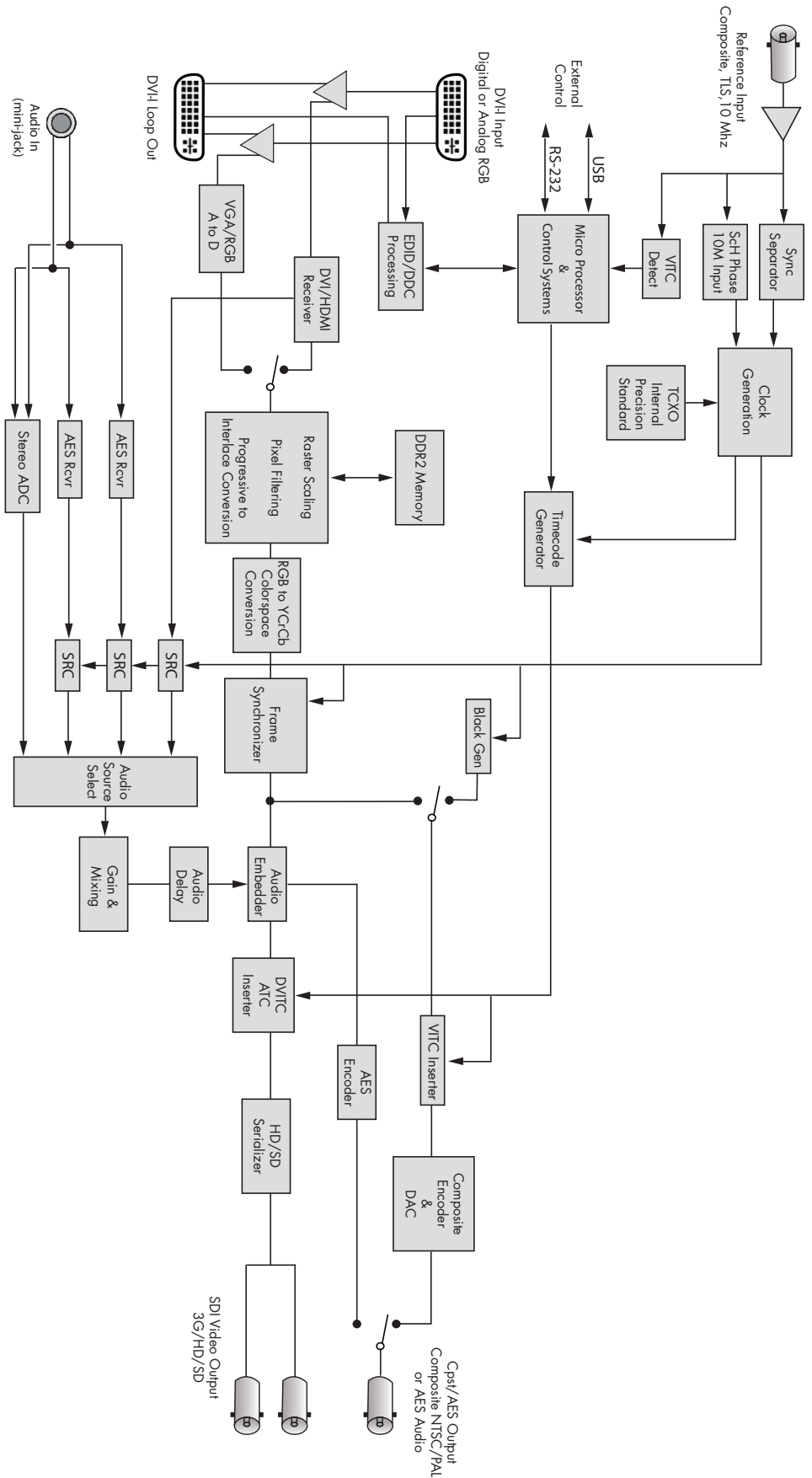

BrightEye Mitto Functional Block Diagram, Landscape View

APPLICATIONS

BrightEye Mitto™ provides the best way to output computer material to video. Possible applications include using YouTube material in a news broadcast, showing financial data from a website on a TV program, displaying viewer emails on a morning talk show, and taking radar information from a computer into a master control switcher for on-air use.

There are several common ways to connect BrightEye Mitto™ in your facility. A typical connection uses a computer monitor and a video monitor.

BrightEye Mitto™ can be used in your facility in many ways:

- With a computer monitor and video monitor.
- With a laptop.
- Without a computer monitor.
- Mitto can be controlled exclusively from the Mitto front panel.
- Mitto can also be controlled from BrightEye PC/Mac control software.
- Mitto has a serial and GPI interface for control through third party equipment such as an automation system.

Getting Started

There are three steps to setting up your Mitto, as listed below. Details are provided on the following pages.

1. If you plan to use BrightEye PC or Mac control software, install it on your computer.
2. Connect Mitto to your computer and video equipment.
3. Set the resolution of your computer's monitor to the best possible resolution, such as 1920x1200 or 1920x1080.

Installing BrightEye Software

BrightEye PC/Mac software offers complete control of BrightEye Mitto™. Timing, proc controls, video formats and more can be controlled with the included software. The software allows you to use your mouse to click and drag over the specific portion of computer video that you want to output. However, BrightEye PC/Mac software is not required as the Mitto front panel controls are intuitive and provide extensive control. You can choose what type of control is best for your facility.

To install software on a PC, insert the CD into your computer, double click on the BrightEye PC icon and follow the prompts.

To install software on a Mac, insert the CD into your computer, then drag the BrightEye Mac icon into your Applications folder.

The latest version of BrightEye PC and BrightEye Mac can be downloaded at <http://brighteyemitto.com>

Connecting Mitto

See the “REAR CONNECTORS” section starting on page 14 for more information about the rear connectors, cables and adaptors used for Mitto.

- Start with your computer and monitor turned off.
- Connect a USB cable from your PC or Mac computer to the Mitto.
- Connect the Mitto’s DVI/VGA Loop Out connector to the computer monitor’s input.
- Connect the computer’s monitor output to the Mitto DVI/VGA Input connector.
- Connect the Mitto’s SDI Out or Composite Out BNC to a video monitor or destination.
- If using audio, connect the computer’s audio output to the Mitto’s Audio In.
- If desired, connect your reference signal to the Ref In. Mitto’s output is genlocked and fully timeable to this reference. Alternately, Mitto can be used without a reference.
- Connect power to the Mitto.
- Turn on the computer and monitors.

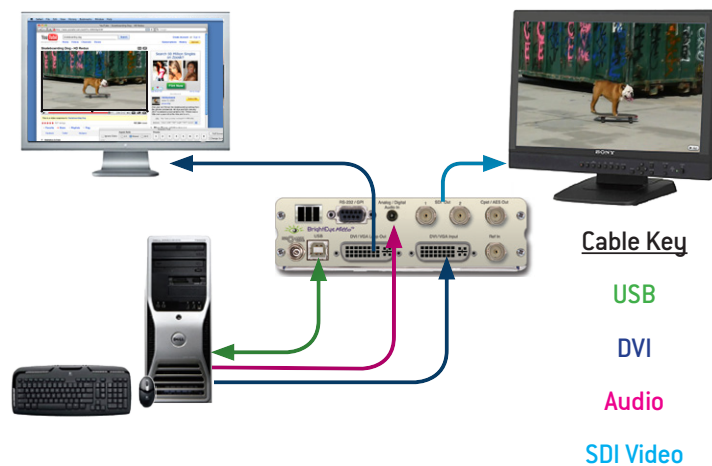

Configuring Mitto and Your Computer Monitor Resolution

Set the resolution of your computer monitor using the Display Control Panel.

PC Users

From the Start menu, go to the Control Panel and double-click Display to bring up the Display Properties window.

Click the Settings tab.

From the Screen resolution control, select a resolution. For the best video output from BrightEye Mitto™, select the highest available resolution on the computer. For HD applications, 1920x1200 or 1920x1080 is preferred. Alternately, you could choose 1024x768. 1920x1200 is the maximum resolution that Mitto accepts.

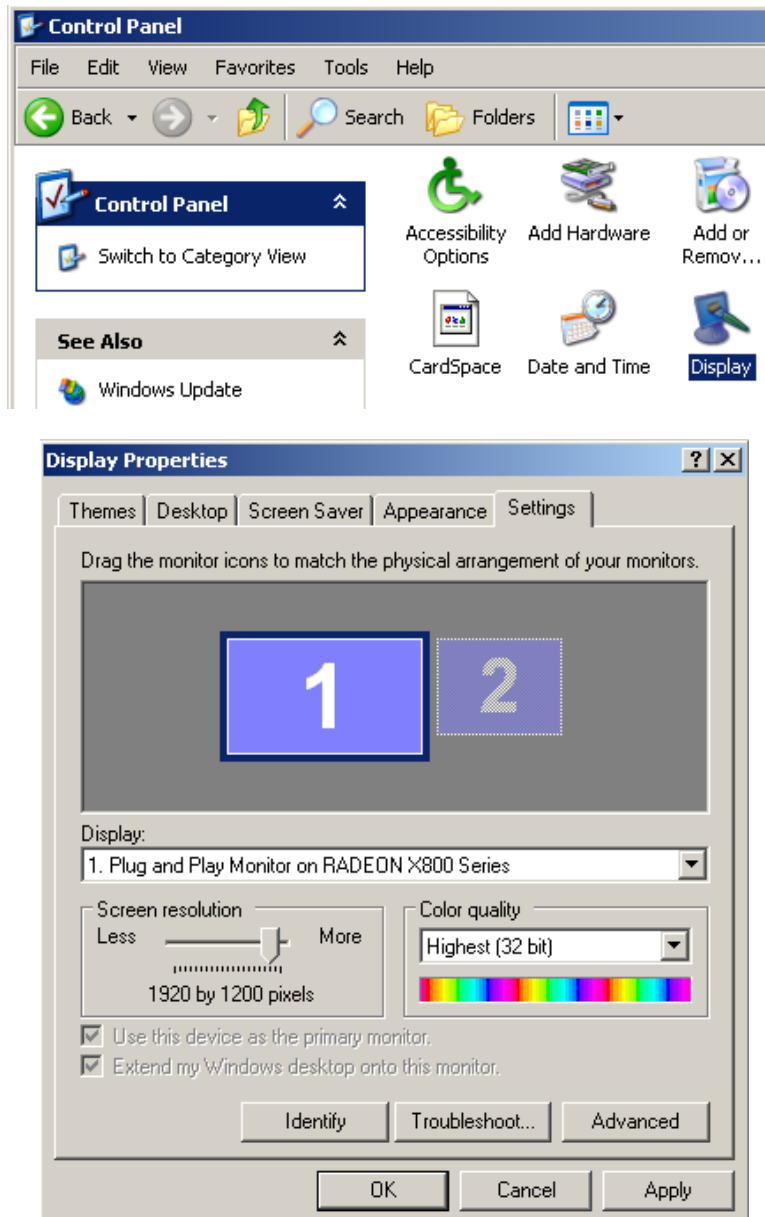

Mac Users

From the Apple Menu, select System Preferences. The System Preferences window displays.

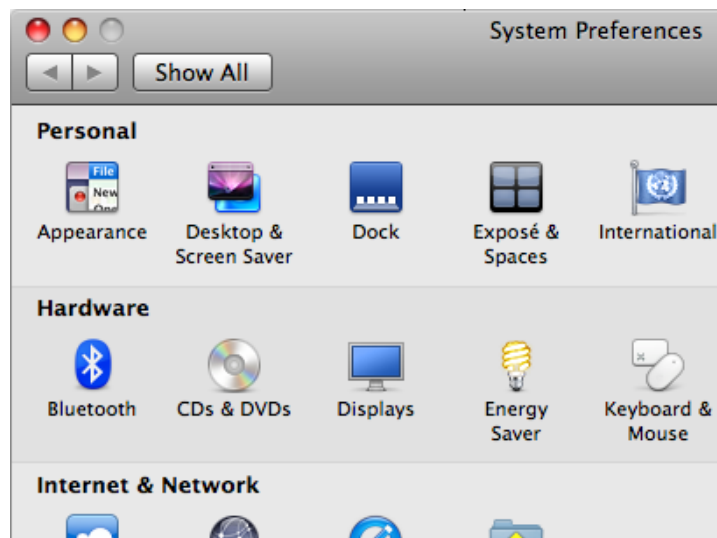

The Mac System Preferences window

Select Displays. A window opens for each monitor attached to your computer. The computer sees Mitto as a monitor. Its name will be either BE Mitto DVI or BE Mitto VGA.

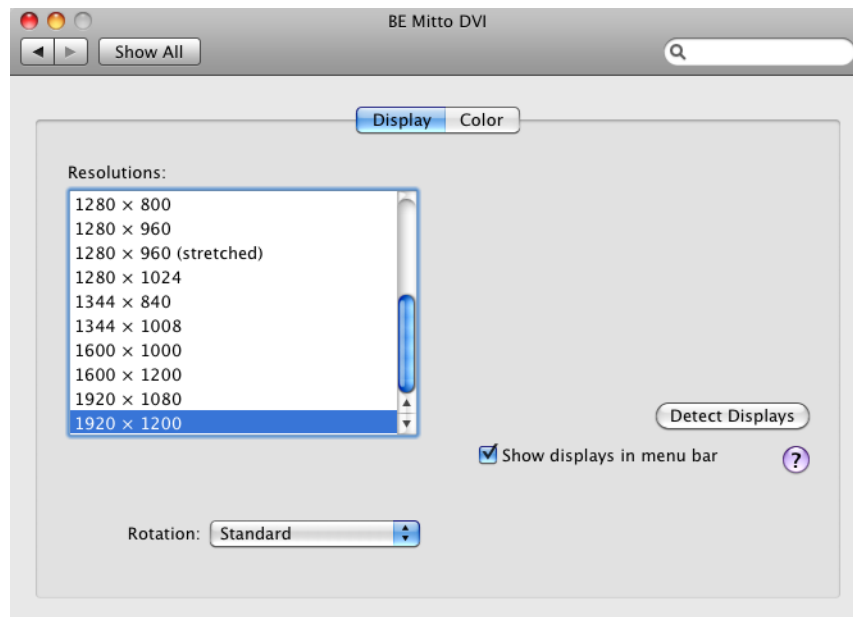

From the Resolutions control, set the resolution sent to the Mitto. For the best video output from BrightEye Mitto™, select the highest available resolution on the computer. For HD applications, 1920x1200 or 1920x1080 is preferred. Alternately, you could choose 1024x768. 1920x1200 is the maximum resolution that Mitto accepts.

When using VGA

When a VGA signal is fed to Mitto, you must choose a VGA resolution using the VGA Resolution control from the Input menu in the BrightEye software. When DVI (digital) is used, Mitto auto senses the resolution and you do not need to indicate the resolution on the VGA Resolution control.

Verifying Resolution Settings for PC and Mac

To make sure that your chosen resolution is being delivered to the Mitto correctly:

From the BrightEye control software's Input menu, look at the "Input Width" and "Input Height" indicator display of the Mitto.

Make sure that these values match what you have selected in the Display control panel. Some video cards may scale their output at some resolutions. You may need to experiment with different resolutions to find one that works properly.

EDID

In many installations Mitto will sit between your PC and monitor. The default configuration for Mitto is that it reports its own EDID to your computer.

Most DVI and HDMI monitors support HDCP encryption which will not work with BrightEye Mitto™. If the computer handshakes with the computer monitor and HDCP is enabled, the encryption will cause the Mitto output to be disabled or distorted. For this reason Mitto provides its own EDID to the computer.

REAR CONNECTORS

All connections to the BrightEye Mitto™ are made on the rear of the unit. Refer to the illustration below for a snapshot reference of the rear connectors. A more detailed explanation of the rear connectors with illustrations of cable connectors follows.

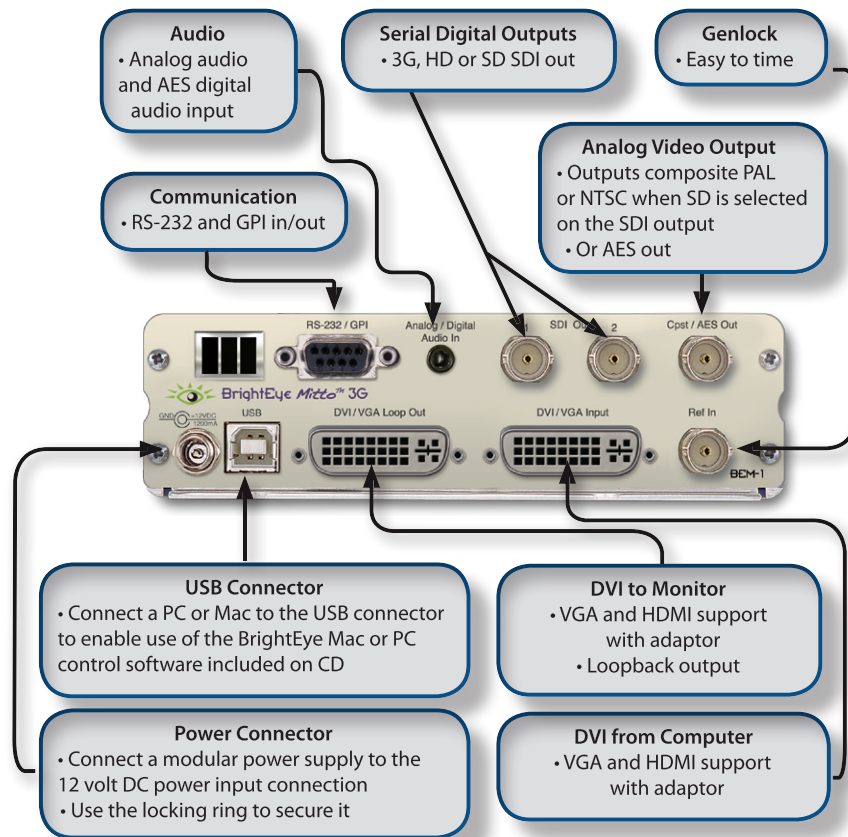

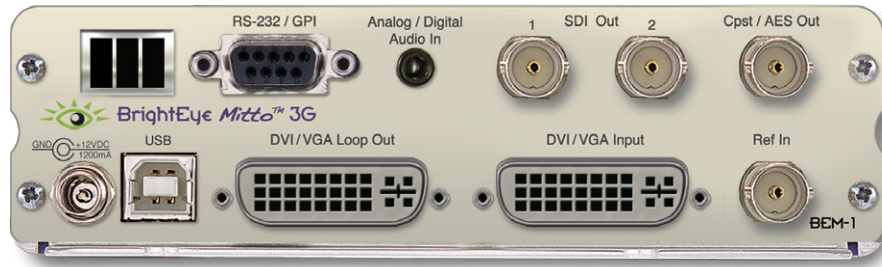

RS-232 / GPI

The RS-232/GPI port can be used with third-party control and automation systems. GPI and RS-232 are supported simultaneously. Additionally, the Ensemble Designs Avenue GPI control panel (part number XYCP) can be used.

Audio/Digital Audio In

Analog Stereo: This is a two-channel input using a standard 1/8" mini-jack. It can be connected directly to the analog audio line level output of a tower or laptop computer. If your computer does not have a line level output, you can also use the headphone output of the computer. The level of this output can depend upon several settings in the computer. The Windows or Mac OS X audio control panels as well as the specific application software will both affect the output level. The general recommendation is to set both of these controls to 80% of their maximum value.

AES or S/PDIF Digital Audio: Mitto can accept four channels of digital audio. A pair of digital audio channels is carried in an AES or S/PDIF bit stream. Mitto can receive digital bit streams on the same audio mini-jack connector. The channels 1/2 bit stream is received on the "left" input of the connector, and the channels 3/4 bitstream is received on the "right" input of the connector. These inputs are processed through sample rate converters which accommodate sampling frequencies from 44.1 to 96 KHz.



SDI Out 1 and 2

The SDI Out 1 and 2 BNCs output the same signal on both BNCs (except when 3 Gb/s Level B is selected.) Choices are SD SDI, HD SDI, or 3 Gb/s HD SDI video. Connect to a video destination such as a router, production switcher, or broadcast monitor.

Composite Out

This analog video output BNC provides composite PAL or NTSC and follows the SD output when SD is selected on the SDI output. When HD is selected for the SDI output, the composite output provides black.

Ref In (Reference In)

The Ref In BNC accepts 1 V P-P Composite Video PAL, NTSC, or HD Tri-Level Sync reference. The video outputs will be zero-timed to the reference, or you can adjust the output timing to anywhere in the television frame. A reference is not required for operation.



Power Connection

Connect the modular power supply to the 12-volt DC power input connection on the far left of the unit. Use the locking ring to secure it. If you don't have the power supply already, contact Ensemble Designs to purchase one.

USB Connector

Connect the USB port to a PC or Mac running BrightEye software for more comprehensive control, diagnostics, and upgrades to the unit. BrightEye PC/Mac Control application software is included on CD that came with your Mitto, or the application can be downloaded at: www.brighteyemitto.com.



DVI/VGA Input

Connect the DVI output of your computer monitor to Mitto's DVI/VGA input. Mitto's DVI/VGA Input and the DVI/VGA Loop Out use DVI-I (integrated) connectors which provide both digital and analog connectivity. The larger group of pins are digital while the four pins on the right are analog.

If your computer has VGA out, use the VGA-to-DVI adaptor that is included with your Mitto.

HDMI is supported with an HDMI-to-DVI adaptor (not included). The HDMI standard provides for carriage of both digital video and audio. Mitto supports two channels of digital audio from HDMI sources.

DVI/VGA Loop Out

If desired, connect the DVI/VGA Loop Out to the DVI input of your computer monitor.

If your computer monitor has VGA in, use the DVI-to-VGA adaptor that is included with your Mitto.

HDMI is supported with a DVI-to-HDMI adaptor.



CONFIGURATION AND CONTROL

Control and operation of the BrightEye Mitto™ is performed from the front panel, the BrightEye Control application, or thru the RS-232/GPI port. Mitto's front panel controls provide extensive control for screen selection and most of the video and audio parameters. Some control settings and parameter choices are available only with BrightEye PC or Mac software. These parameters cannot be monitored from the front panel.

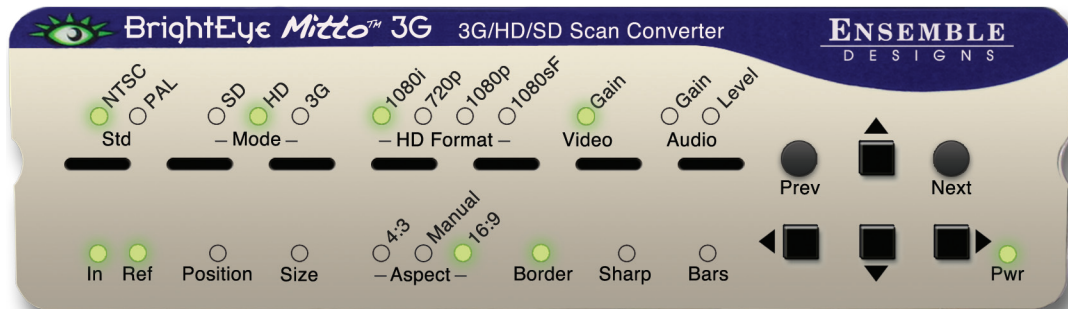

Adjusting Parameters from the Front Panel

The six buttons on the right side of the Mitto's front panel are used to navigate the controls. If you are familiar with our BrightEye products, you will notice that the Mitto has three additional buttons.

Prev and **Next** navigate through the various controls, such as Aspect and Position. When a control is selected its LED blinks on and off. Arrows change values for the control you selected.

Pressing the **Right Arrow** or **Left Arrow** advances the selection within a given section of parameters, or increases (**Right Arrow**) or decreases (**Left Arrow**) the value of a selected parameter.

Resetting to Default Values

Holding the **Left Arrow** and **Right Arrow** buttons at same time restores the selected control to its default value. For example, with the Position control selected, pressing the **Left Arrow** and **Right Arrow** buttons at the same time will cause the horizontal Position value to be restored to its default value, which is all the way to the left side of the computer monitor. Similarly, with the Position control still selected, holding the **Up Arrow** and **Down Arrow** buttons at the same time restores the vertical Position to be restored to its default value, which is at the top of the computer monitor.

The front panel LED indicators light green when in their default values, and they light orange when values other than the default are selected.

Press and Hold to Accelerate Movement Controls

The arrow buttons have a hold function. The behavior of pressing and holding an arrow button depends on which control you have selected. For example, with the Position control selected, if you press and hold the **Right Arrow** button, the screen selection will move at an increasing rate to the right across the computer monitor.

Front Panel Controls and Indicators

Status Indicators

The following status indicators are provided on the front panel:

Std (Standard): The currently selected output standard (NTSC or PAL) will illuminate green. This is also a control to choose the standard. You can choose to operate in the NTSC standard, which would be 59.94 fields or 29.97 frames per second, or the PAL standard, which would be operating at 50 Hz.

Mode: The currently selected mode (SD, HD, 3G) illuminates green. Choose between SD (standard definition), HD (high definition), and 3 Gb/s (high definition). Currently, HD is the most commonly used high definition signal.

HD Format: The currently selected HD Format is illuminated green. Choose between 1080i, 720p, 1080p, or 1080sF.

Video Gain: The video gain control adjusts the overall gain level for the video output. If you want more controls than just the overall level, see the Proc tab in the complete control system accessible by using the BrightEye PC or BrightEye Mac software that connects to the USB port on the back of the Mitto.

Audio

Gain: Audio gain control used to set the level. It displays green when the control is at unity. It displays orange when the control is set higher or lower than unity.

Level: The Audio level indicator reflects the level of the audio being routed to output channels 1 and 2. If the level is within the peaking threshold, it displays green. The indicator displays yellow if the level is approaching the peaking threshold, and red if it exceeds the peaking threshold.

In (Input): The Input indicator will light green if you have a valid DVI or VGA input connected from a computer.

Ref (Reference): The Reference indicator will light green when a valid reference is present and locked.

Position and **Size** are used to select the portion of the computer screen to be scan converted and output to either standard definition or high definition video. **Position** determines the upper left corner of the region you are going to output, while **Size** determines the lower right corner of the region for output.

When the **Position** LED is blinking, adjust the position of the upper left corner of the selection. Use the four arrows to control position. Press and hold for faster movement.

Short cut: Press and hold left and right arrows at the same time to reset the H position to default values. Press and hold up and down arrows to reset V position.

Size determines the lower right corner of the region for output.

When the **Size** LED is blinking, adjust the position of the lower right corner of the selection. Use the four arrows to control size.

Short cut: Press and hold up and down (or right and left) arrows at the same time to reset to maximum possible size.

Maximum Screen Selection Shortcut

To maximize the screen selection instantly, hold down the **Up**, **Left**, and **Right Arrow** buttons simultaneously while **Position** or **Size** are active. Within the constraints of the currently selected aspect ratio, Mitto will instantly maximize the screen selection on the computer monitor.

Aspect lets you set a fixed aspect ratio of the portion of the screen you are selecting. 16:9 aspect ratio is appropriate for high definition. 4:3 aspect ratio is appropriate for standard definition. With Manual selected, you can choose any arbitrary aspect ratio. Pillar boxes or letter boxes are added automatically so that the output matches the output standard selected.

The **Border** control lets you adjust a black border around the selected video as it appears on the high definition or standard definition video output.

Sharp: The Sharpness control adjusts the filters in Mitto. You can adjust the sharpness to optimize how particularly challenging pieces of video are filtered prior to output.

Bars: Turn color bars on or off. Turn bars off for normal video operation.

Pwr (Power): The power indicator illuminates green when the BrightEye unit has power and the internal voltage regulator is functioning correctly.

USING THE BRIGHT EYE CONTROL APPLICATION

The BrightEye PC and BrightEye Mac applications included on CD-ROM are designed to allow you to configure and control the BrightEye Mitto from a personal computer. Instructions for installing and using this software application are given in the PDF manual on the CD-ROM.

Software version requirement

BrightEye PC or BrightEye Mac version 2.0 or later is required.

If the BrightEye Mitto is connected to a computer running this software, the menus described in the following pages are available for controlling and monitoring the unit.

Configuration and Setup

The configuration and setup process will walk you through the following three menus as these are most useful for configuring your system prior to use:

1. Output Menu
2. Audio Configuration Menu
3. Input Menu

Output Menu

The three controls along the top of the Output menu (**Standard**, **Mode**, **HD Format**) are used to determine Mitto's output standard. Regardless of what type of input is fed into Mitto, whether it is DVI or VGA, the output will match the configuration selections you have made.

The **Standard**, **Mode**, and **HD Format** controls are also accessible on the Mitto front panel.

Standard: Select NTSC or PAL.

Mode: Select SD, HD, or 3G.

HD Format: If working with HD, select 1080i, 720p, 1080p, or 1080sF.

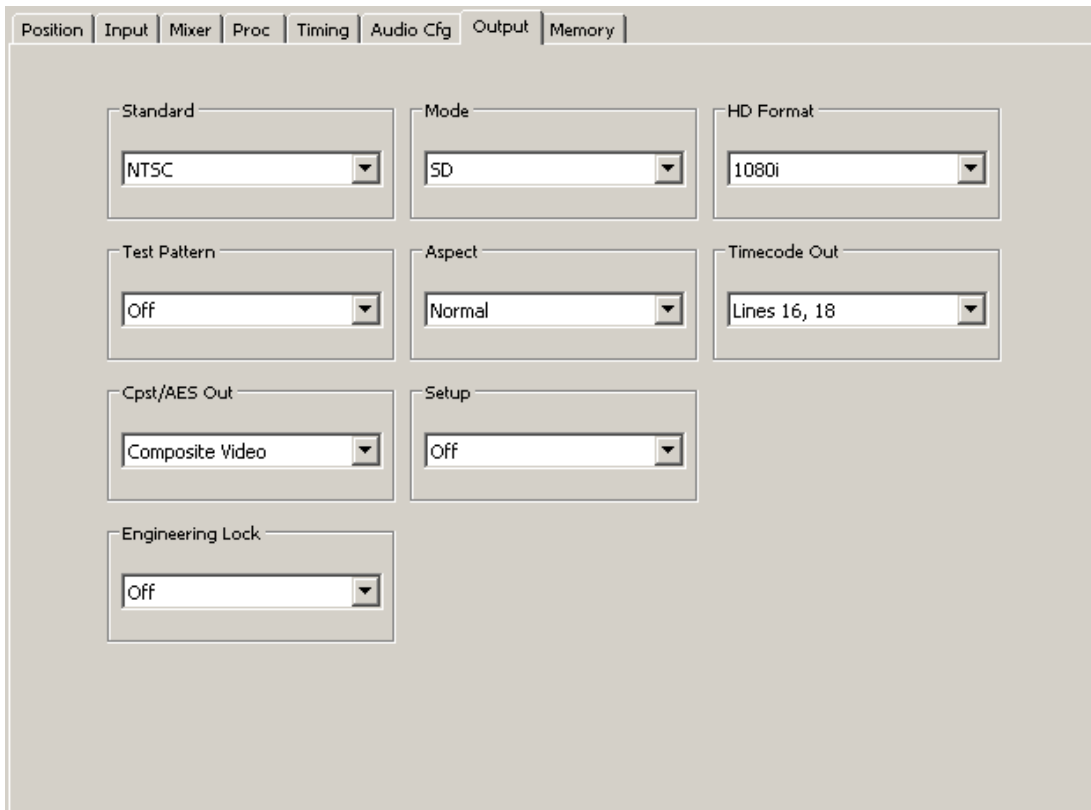

The screenshot shows the 'Output' menu configuration interface. At the top, there is a navigation bar with tabs for Position, Input, Mixer, Proc, Timing, Audio Cfg, Output, and Memory. The 'Output' tab is selected. Below the navigation bar, there are several configuration controls, each in a separate box with a dropdown arrow:

- Standard:** NTSC
- Mode:** SD
- HD Format:** 1080i
- Test Pattern:** Off
- Aspect:** Normal
- Timecode Out:** Lines 16, 18
- Cpst/AES Out:** Composite Video
- Setup:** Off
- Engineering Lock:** Off

Test Pattern: When Mitto's internal color bars are turned on, there will be bars and tone from Mitto's internal tone generator on the output. Turn bars on or off. Turn bars off for normal video operation.

Aspect: The Aspect ratio control is ordinarily left in Normal. Mitto guarantees that the aspect ratio of the selection you have made on the computer will be output to video with the proper aspect ratio. Circles will stay circles.

There may be times when you would choose to override normal aspect ratio. If you select Anamorphic, it will allow you to select a region on the input side that is the output of the computer and pin the corners of that region to the output space. In that case, depending on how you have made your selection, circles may not be circles. But in certain cases, that may be exactly what you are intending.

Note: If you are experiencing issues with maintaining the correct aspect ratio, please see the Troubleshooting section on page 38 for recommendations.

Timecode Out: Mitto will generate timecode in ATC (or ancillary timecode format) when running in SD, and in DVITC (or digital vertical interval timecode) when running in HD. You can turn the timecode off. When you turn it on use this control to select which pair of lines it will appear on for an SD signal. Any selection, such as Lines 16 and 18, will work for an HD signal.

Composite/AES Out: Select between Composite Video or AES Audio for the Cpst/AES out BNC.

Setup: The **Setup** control is used to turn off and on 7.5 IRE of setup or black offset in the analog composite output for NTSC applications.

Engineering Lock: When the Engineering Lock is on, it locks, or grays out, the Standard, Mode and HD Format controls on the Output menu; it also locks all the controls on the Timing menu (vertical timing, horizontal timing, and fine phase timing).

Audio Configuration Menu

Audio Input

Mitto has three possible audio inputs.

1. The first type of audio input is analog. There is an 1/8 inch mini-jack in the back of Mitto that will accept two channels of stereo analog audio. When the Analog input is selected, the left channel is assigned to Input 1 and the right channel is assigned to Input 2. Mixer Inputs 3 and 4 are not used.
2. The second type of audio input is AES. If you choose AES, the 1/8 inch mini-jack in the back of Mitto can accept two AES bitstreams (four channels), one on the “left” pin of the connector and one on the “right” pin. When AES (or S/PDIF) is selected, the bit stream connected to the “left” input will appear on Mixer Inputs 1 and 2, and the “right” bit stream will appear on Mixer Inputs 3 and 4.
3. The third type of audio input is through HDMI video coming in through the DVI port. The HDMI standard can support eight channels of digital audio. HDMI audio will appear on Mixer Inputs 1 and 2. If you select DVI, an HDMI source fed to the DVI connector will provide the audio into Mitto.

Mitto has two audio output capabilities.

1. The four channels of audio from the audio mixer can be embedded in the SD SDI or HD SDI output. Embedded audio travels with the digital video through cables, distribution amps, and routers without the need for any additional wiring. The SDI standard allows 16 channels of embedded audio, which is organized into four groups of four channels each. The four channel output from Mitto fits into a single group. You can assign the audio to a specific group using the Embedding control in the Audio Config menu. This control also allows you to turn embedding off.
2. Mitto can also output two channels of digital audio as an AES bit stream (just like the input capability). This AES output shares a connector with the Composite Video output. The Cpst/AES Out control in the Output menu configures this connector to output either Composite video, AES channels 1 and 2, or AES channels 3 and 4.

Embedding

You can control how audio is being embedded into the HD or SD SDI output. If Embedding is turned Off, no audio will be embedded into the output. If you set it to Group 1, it will embed audio into group 1 (channels 1, 2, 3 and 4).

Analog Reference Level

Use this control to select the nominal reference level for the analog inputs. Mitto’s analog audio input is unbalanced which is often used with -10 dBu analog reference level. Select the appropriate reference level for your facility.

Digital Reference Level

Choose either -20dBFS or -18dBFS, relative to full scale.

Peak Indicator

The nominal operating audio level indicator and peak audio indicator provide a way to monitor audio levels at a glance. This controls allow you to set the amount of headroom that you wish to reserve before the clipping or peak indicator illuminates. For example, if this control is set to 6 dB Headroom, the peak indicator will not flash red unless the audio level exceeds the 6 dB Headroom point.

Audio Delay

Mitto has variable audio delay to help you keep lip sync correct. The delay can be adjusted from 0 to 1000 milliseconds (mSec).

In the 50Hz domain, there are 40 mSecs in a frame, and 33 mSecs in a frame in the 60 Hz or NTSC frame rate domain.

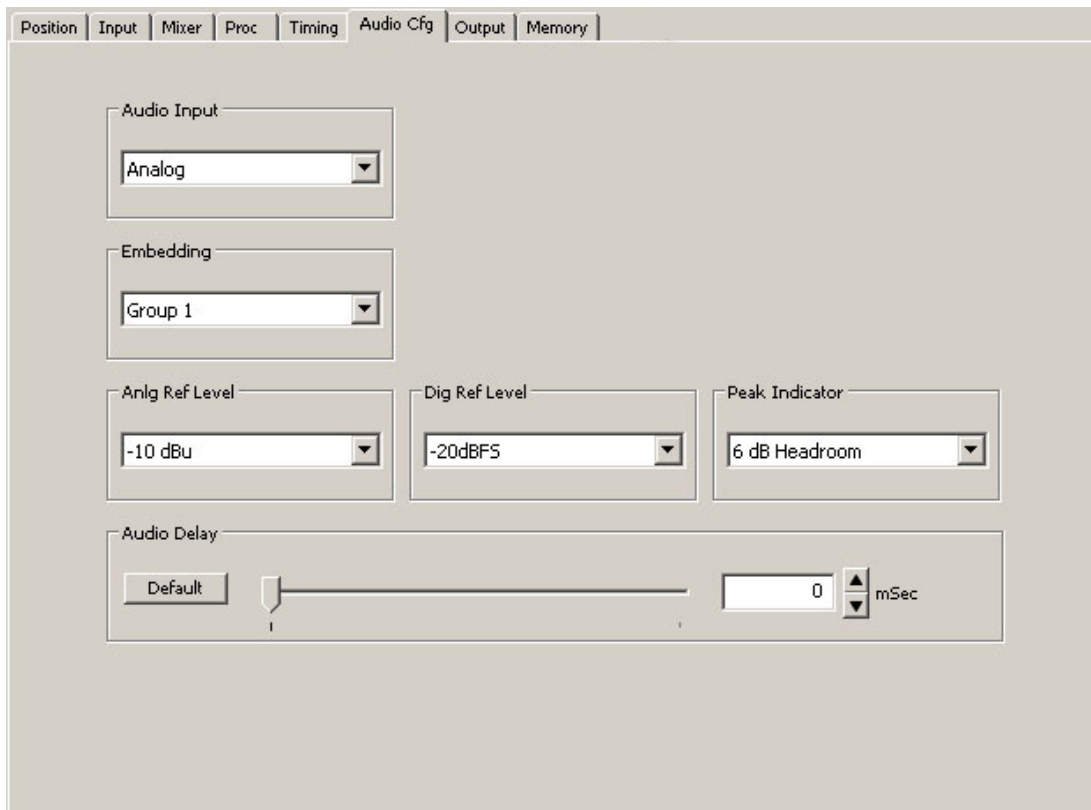

Input Menu

The Input menu is for selecting a reference source (external or internal) and monitoring reference status indicators and input indicators.

- **Input Selection** – Defaults to DVI. Select VGA if needed. This control cannot be set from Mitto's front panel. Use BrightEye PC/Mac software to set this control to VGA if needed.
- **VGA Resolution** – When DVI is used this control does not need to be adjusted as Mitto will auto sense the resolution. When a VGA signal is fed to Mitto, set the resolution of the computer's video monitor here.

Note: With a VGA signal, you must make sure that the resolution setting chosen from the VGA Resolution control matches the resolution setting of the computer monitor. Otherwise, you may see a blue screen.

- **Input Pres** – The Input Present status field indicates whether there is an input present.
- **Input Width** – The Input Width field indicates the width of the computer output in pixels.
- **Input Height** – The Input Height field indicates the height of the computer output in pixels.
- **Ref Source** – Select either Internal Ref or Ext Ref.
- **Reference** – The Reference indicator shows what sort of reference signal is present.
- **Sync Lock** – The Sync Lock indicator reflects the status of the Mitto being properly locked and synchronized to the reference.
- **Timecode Ref** – The timecode comes from the reference input. This control allows you to select which line of the black composite reference carries the timecode to Mitto. Lines 16 and 18 are typical choices.

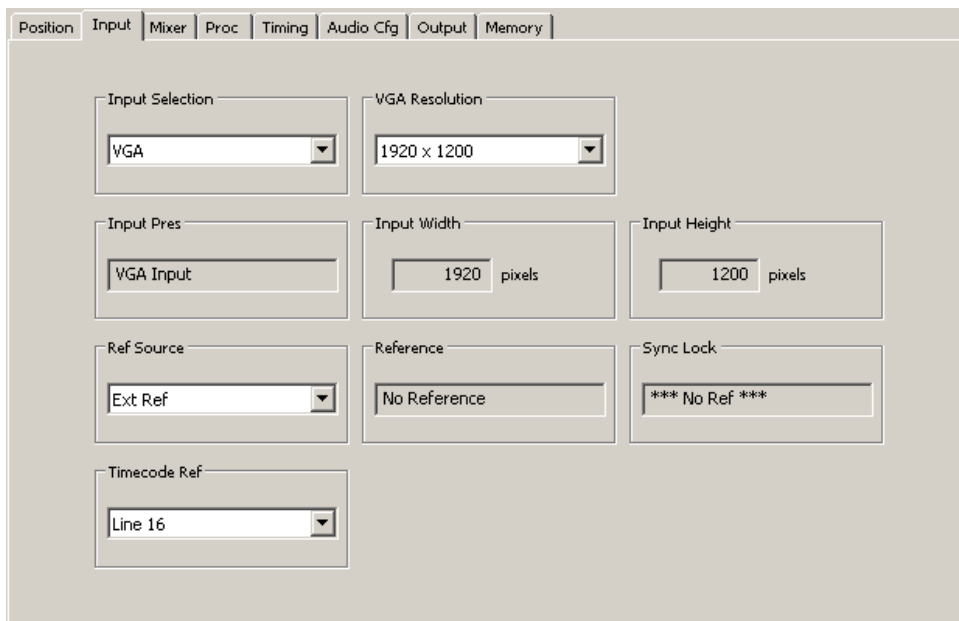

The screenshot shows the 'Input' menu of the software interface. The menu is divided into several sections:

- Input Selection:** A dropdown menu set to 'VGA'.
- VGA Resolution:** A dropdown menu set to '1920 x 1200'.
- Input Pres:** A text field displaying 'VGA Input'.
- Input Width:** A text field displaying '1920 pixels'.
- Input Height:** A text field displaying '1200 pixels'.
- Ref Source:** A dropdown menu set to 'Ext Ref'.
- Reference:** A text field displaying 'No Reference'.
- Sync Lock:** A text field displaying '*** No Ref ***'.
- Timecode Ref:** A dropdown menu set to 'Line 16'.

Position Menu

The Position menu is used to select a portion of the computer monitor display for scan conversion. It is also used for selecting the Aspect Ratio, for creating a border and for setting the Sharpness control.

The Position menu includes a Screen Select window, indicating what portion of the computer monitor output has been selected for scan conversion. The light blue region represents the entire computer output screen. It indicates the resolution of the computer monitor in terms of pixel height and width. In the example shown below, the resolution being used is 1280 by 1024. The highest resolution that Mitto supports is 1920 by 1200.

The smaller rectangle, slightly darker blue, indicates the selected area or Selection. It shows not only the size but also the position within the computer output that is being selected for scan conversion. In the example shown below, the Selection is 1098 by 618 pixels.

The upper left corner of the Selection is the "Position Corner." The Position arrow buttons act on the location of the entire Selection relative to the Position Corner. For example, as the Position Corner moves 20 pixels to the right, the entire Selection also moves 20 pixels to the right. Note that moving the Position Corner does not change the Selection's shape or size.

The lower right corner of the Selection is the "Size Corner." The Size Corner can be moved relative to the Position Corner. In contrast to moving the Position Corner, moving the Size Corner causes the Selection's shape or size to stretch or shrink.

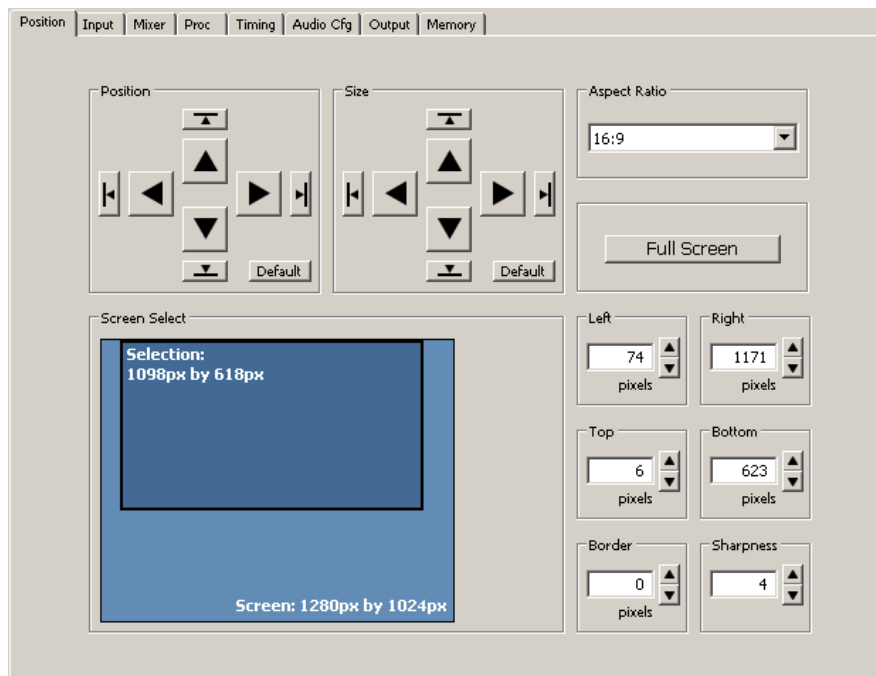

The Position menu with controls for Position, Size, Aspect Ratio, the Screen Select window, and the Border and Sharpness controls.

Four ways to control Selection's Position and Size

1. When controlling Mitto from the BrightEye PC or Mac application, the Position and Size can be adjusted through the Selection Tool, which is part of the BrightEye Mac or PC application. See page 30 for more details about the Selection Tool.
2. A second way to control the Position and Size is through the **Position** and **Size** arrow buttons in the Position menu.
3. A third way is through the **Left, Right, Top** and **Bottom** controls in the Position menu, located to the right of the Screen Select window.
4. A fourth way to control the Position and Size is from the front panel of Mitto. With the Position or Size control selected on the front panel, you can use the **Left Arrow, Down Arrow, Right Arrow** and **Up Arrow** buttons.

The four directional arrow buttons move the selection one pixel at a time for each click. Pressing and holding down a button will accelerate the movement of the Selection. Notice that when moving the Selection's Position, the Selection remains the same size. Moving the Selection's Size, however, will change the size and shape of the Selection.

Maintaining Aspect Ratio

To adjust the size of the Selection, the upper left Position corner stays in the same position, but the lower right corner of the selection moves with the Size control. With an aspect ration of 16:9 selected, if you move the Size control to the right, it will make the Selection wider, and it will also make it taller in order to maintain the 16:9 aspect ratio. If you use the Size control to raise the lower right corner, it also pulls the right edge in to maintain the chosen aspect ratio. The aspect ratio of 4:3 works the same way.

Using Manual Aspect Ratio

By selecting a manual aspect ratio, you can increase the width independently of the height. It is possible to select an area that is much wider than can be shown on a 16:9 high definition display; for example, a 1362 by 436 pixel selection. When this is output, Mitto automatically letter boxes the content with a black region above and below so that the aspect ratio of the content will be correct. Similarly, Mitto automatically pillar boxes the content as needed with a black region on either side to maintain the correct aspect ratio for output when the selection is taller than the output aspect ratio would normally allow.

One Click to Move Selection to an Outside Edge

Clicking one of the smaller directional Position arrow buttons (with the perpendicular line) causes the Selection area to move immediately to the outside edge of the direction chosen with one click. Similarly, clicking the smaller down or right Size arrow buttons causes the Size of the Selection area to move to an outside edge. However, clicking the smaller left or up Size arrow buttons minimizes the size of the Selection.

Position Default Button – Clicking the Default button for Position immediately places the position of the Selection area at the upper left corner.

Size Default Button – Clicking the Default button for Size immediately maximizes the size of the Selection area within any aspect ratio constraints, but does not change the Position of the upper left corner of the Selection area.

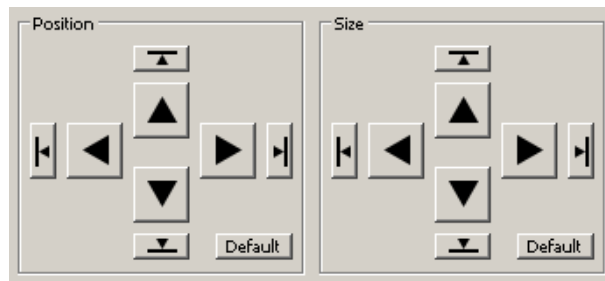

Full Screen – Clicking the Full Screen button instantly maximizes the size of the Selection area. The Position will be moved to the upper left corner while the Size will be maximized within any aspect ratio constraints.

Border – Lets you adjust a black border pixel width around the selected video as it appears on the high definition or standard definition video output.

Sharpness – The Sharpness control ranges from a minimum value of 1 up to a maximum value of 8. This is a set of variable filters used to configure the processing through which Mitto is moving the input video to the output. The mid-range setting of 4 is recommended as a good place to start.

Selection Tool

The region of the computer screen that is inside the Selection Tool will be output to video.

To access the selection tool, click the **Show Selection Tool** button along the top tool bar in BrightEye PC or Mac. The Selection Tool displays as a floating rectangle, floating over the top of everything else running on the computer, including any graphics programs.

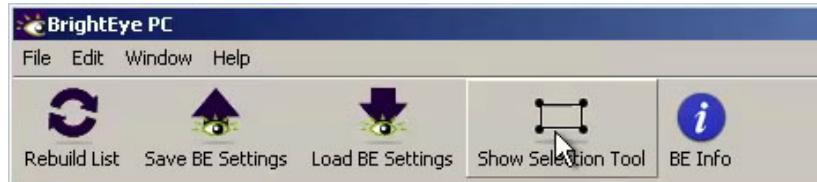

The Show Selection Tool button on the top toolbar of BrightEye PC

When you click the **Show Selection Tool** button, it toggles into the **Hide Selection Tool** button. Similarly, when you click the **Hide Selection Tool** button, it toggles into the **Show Selection Tool** button. Click the **Hide Selection Tool** on the toolbar to put the Selection Tool away.

Click and drag the Selection Tool to move and resize the selection for outputting to video. Aspect ratio constraints apply to the Selection Tool in the same way that they apply to the Screen Selection window in the Position menu.

Tip: If you have clicked the **Show Selection Tool** button but do not yet see it, click and hold the **Up arrow** in the Size control to reduce the size of the Selection Tool. Once it is small enough, it will become visible on the computer monitor. Clicking and holding the size **Up arrow** reduces the size of the Selection Tool and brings it into view.



The Selection Tool shown floating over the computer monitor

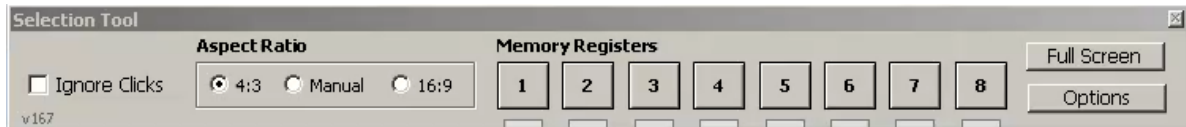

The Selection Tool floating toolbar

Selection Tool floating toolbar

When using the Selection Tool, it is accompanied by a Selection Tool floating toolbar. From this toolbar, you can adjust the Aspect Ratio (4:3, Manual, or 16:9). The Memory Registers are also accessible for saving and recalling position settings.

Ignore Clicks checkbox

Click the Ignore Clicks checkbox when you need to be free to interact and click on your computer screen without in any way disturbing the position and size of the Selection Tool. When the Ignore Clicks checkbox is selected, the color of the Selection Tool will brighten slightly.

Deselect the checkbox to restore interactivity with the Selection Tool.

Aspect Ratio

Select 4:3, Manual, or 16:9.

Memory Registers

Click Memory Registers to recall previously saved position settings. Save new position settings by clicking and holding a Memory Register button until it turns green.

Full Screen button

The Full Screen button on this toolbar has the same function as the Full Screen button on the Position menu. It is used for maximizing the size of the Selection Window, but within the constraints of the selected aspect ratio and output settings.

Options button

Click the Options button to access a color palette tool for changing the color of the Selection Tool.

Screen Select window

Note that the Screen Select window within the Position menu tracks the exact movement of the screen selection (its position and size) within the context of the entire screen monitor resolution space. This is shown by the location of the Selection in the Screen Select window.

The exact pixel dimensions (width and height) are also indicated.

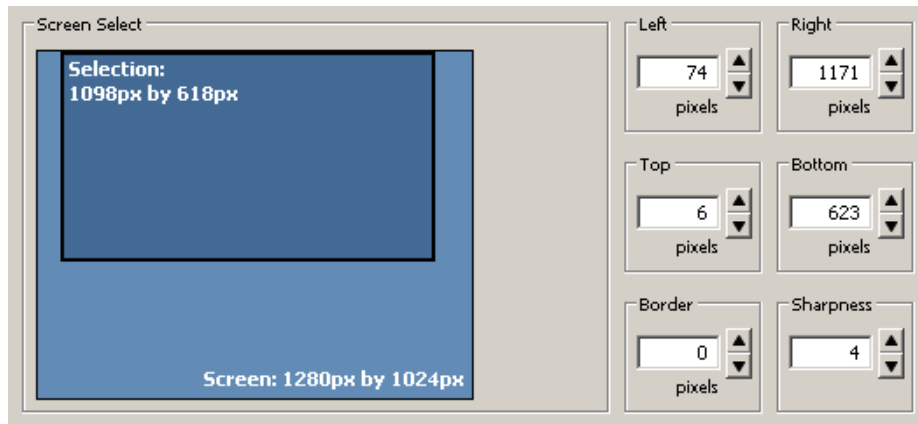

The Screen Select window within the Position menu

Appearance of Selection Tool when in Manual Aspect Ratio

When Manual aspect ratio is selected, extra handles display on the Selection Tool to facilitate freely changing its height and width independently. 16:9 and 4:3 aspect ratio constraints do not apply. Notice the additional handles located in the middle of each side.

Moving Selection Tool: To move the Selection Tool without resizing it, click and drag directly on one of the sides of the tool, not on a handle.

Resizing Selection Tool: To resize the Selection Tool, click and drag directly on any of the eight handles of the tool. You can resize by clicking and dragging one of the handles on a side, or on a corner.

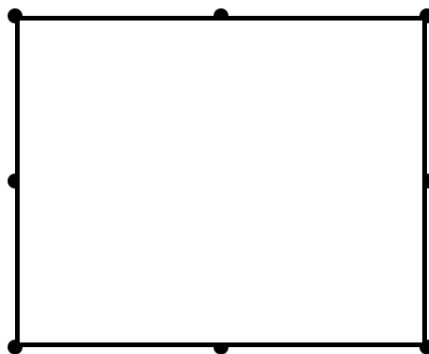

The Selection Tool when the aspect ratio is set to manual

Mixer Menu

Mitto has a four-channel audio mixer with four inputs and four outputs. It allows you to adjust the level of each channel independently. Any audio input can be assigned to any audio output.

If you have chosen analog audio as the input, which would be stereo, then you will have two input channels: Input Channel 1 and Input Channel 2.

For example, you could route Input Channel 1 to Output Channel 1, Input Channel 2 to Output Channel 2, Input Channel 3 to Output Channel 3, and Input Channel 4 to Output Channel 4.

Another configuration example would be to turn off Input Channels 3 and 4 by de-selecting the Output Channel assignments, meaning that no Output Channels are selected for Input Channel 3 or Input Channel 4. Then route Input Channel 1 to Output Channel 1 and Output Channel 3, and Input Channel 2 to Output Channel 2 and Output Channel 3. Now Channels 1 and 2 will have the same original stereo content, and the Channel 3 will output a mono mix-down.

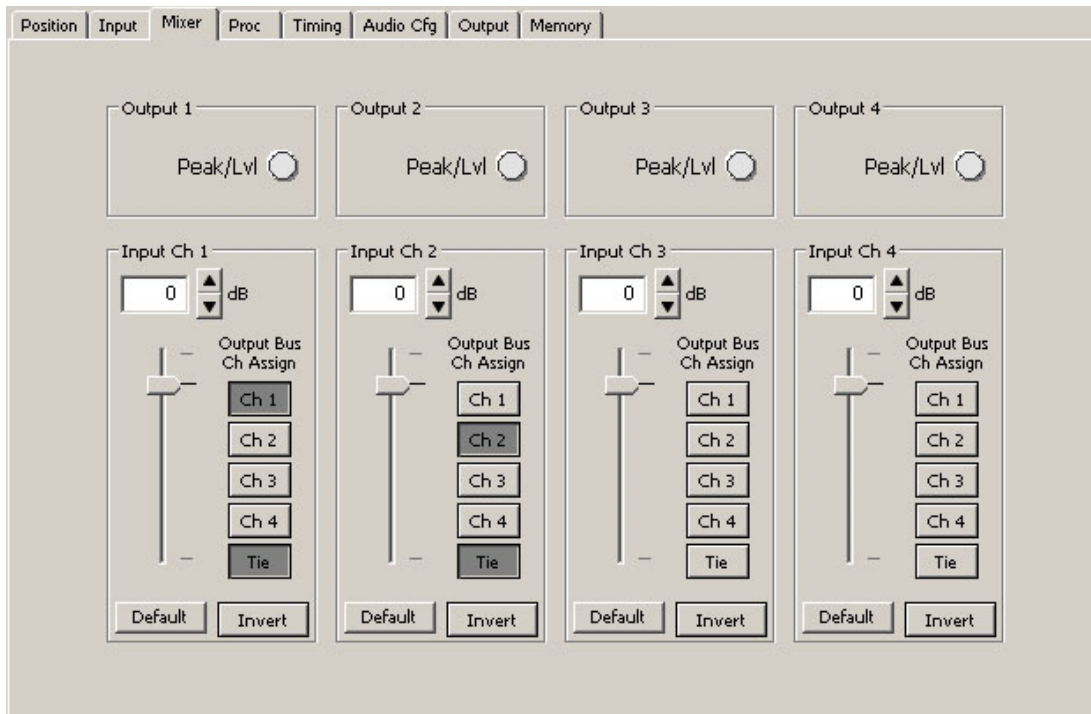

Proc Menu

The Gain control on the front panel is the same control as the Gain control in the Proc menu shown below. The Proc menu offers more controls than the front panel's Gain control.

The Proc amp menu offers a Gain control, which affects the overall video level. The Proc menu also includes controls for the Chroma amplitude, the Pedestal or black level, and the Hue. This is an NTSC-style Hue rotation. It can be used to make small adjustments in colorimetry.

The nominal settings for all of these controls would be 100% of overall Gain and Chroma; zero adjustment to Pedestal and zero degrees of Hue rotation.

You can change these values by clicking and dragging on the slider control, by using the up and down arrow buttons, or by entering values directly into the fields.

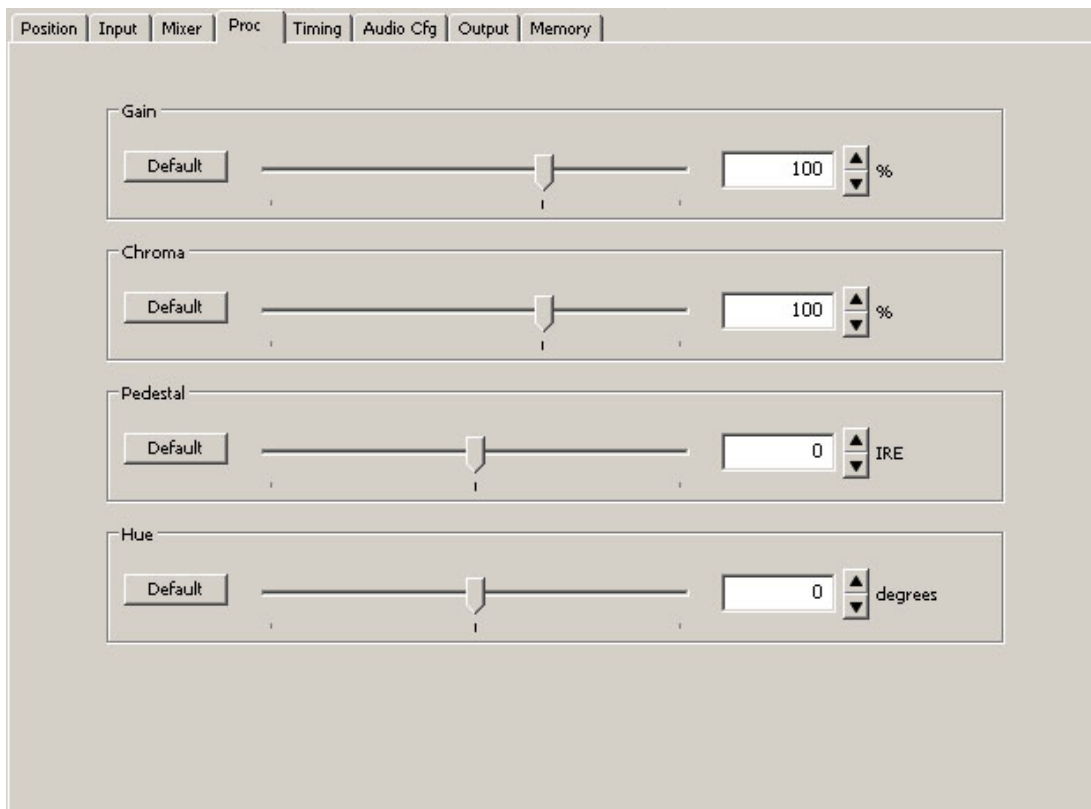

Timing Menu

The Timing controls adjust the timing of the HD SDI or SD SDI and composite output of Mitto with respect to the reference input. If you set all three of the timing controls (Vertical, Horizontal, Fine Phase) to zero, then Mitto's output will be in exact time with the reference.

If, for example, you need to have Mitto's output be one line early with respect to the reference in order to auto-time properly into a production switcher, set the Vertical Timing to -1.

- **Vert Timing** – Set the vertical timing in lines. Use the slider controls or arrows to select a value, or enter a value directly into the number field.
- **Hor Timing** – Set the horizontal timing in clocks. Use the slider controls or arrows to select a value, or enter a value directly into the number field.
- **Fine Phase** – Set the fine phase timing in nsecs to color time the composite output. Use the slider controls or arrows to select a value, or enter a value directly into the number field.

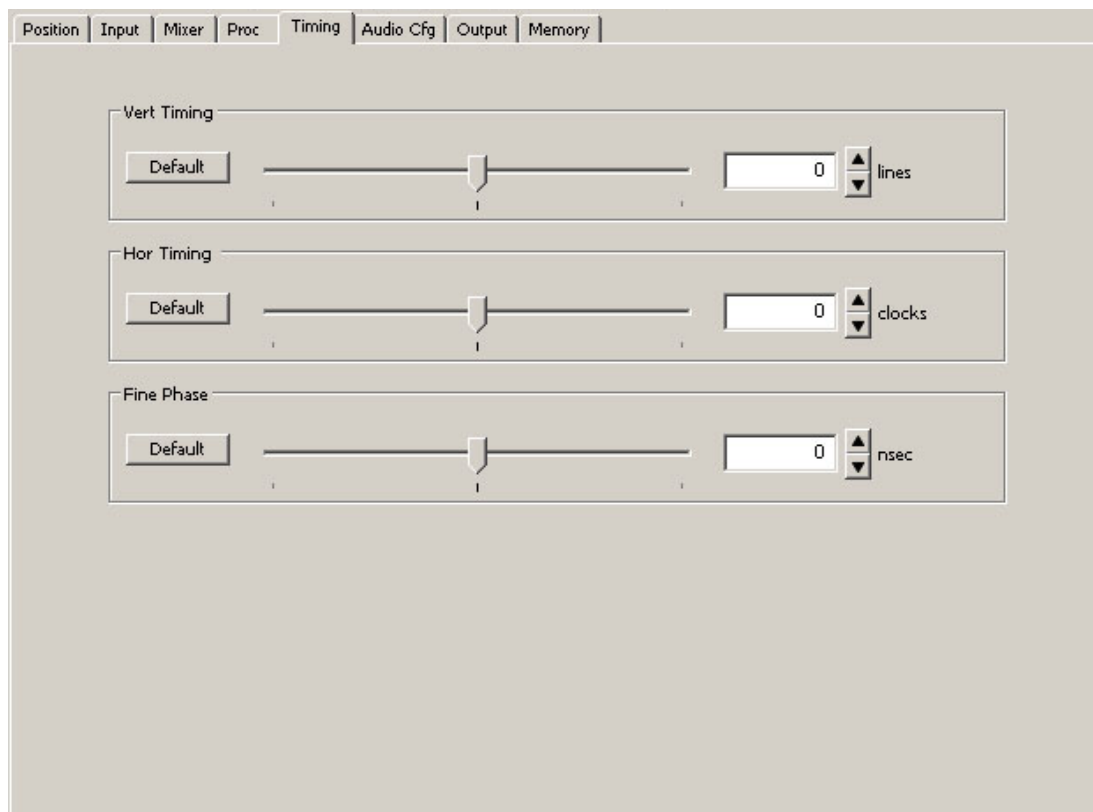

Memory Menu

The Memory menu provides access to a set of memory registers used to cut or switch between up to eight different screen selection settings. Each memory register can save position, size, aspect ratio, border, and sharpness settings. Clicking a saved memory register instantly switches the position and size, the aspect ratio, border and sharpness to the saved settings associated with that particular memory register.

To save settings to a memory register

1. Select a desired position and size, aspect ratio, border size, and sharpness settings.
2. From the Memory menu, click **Save**, then click **Register 1**. The **Register 1** button turns green, indicating that it has saved the screen selection settings.
3. To save additional memory registers, repeat the above procedure, except click **Register 2** after clicking **Save** to create a second, **Register 3** after clicking **Save** to create a third, and so forth. Note that the last memory register to be saved or recalled will be green.



TROUBLESHOOTING

There is no output signal, and/or the selection tool is not behaving as expected

Recommendation: Make sure that the resolution settings of Mitto and the computer match one another. Set the resolution of your computer monitor to the highest possible resolution. For best results, choose one of these resolutions:

- 1920 x 1080
- 1920 x 1200
- 1024 x 768

Then use Mitto's front panel or BrightEye Mac/PC software to set Mitto to the *same resolution*.

If you have trouble with using a resolution setting such as 1680 x 1050 or 1280 x 800, try one of the above listed resolutions instead.

For VGA, choose the highest resolution that is available on both your computer and on the BrightEye Mac/PC software Input menu from the VGA Resolution pull-down selector.

Aspect ratio is not being maintained correctly

Recommendation: Turn off scaling on your computer's graphics card. All scaling should be performed by BrightEye Mitto to ensure pixel size and shape are maintained properly.

If the picture being output by Mitto is not maintaining its correct aspect ratio (for example, a circle is egg-shaped), check your computer's graphics card settings and turn off any scaling that the computer graphics card may be applying. Look for a tab that controls your graphics card. It may be referred to as something other than "scaling" such as "modify" depending on which controls are provided by the specific graphics card in your computer.

Mitto reports a different resolution than the settings you have applied to your computer

Recommendation: Turn off scaling on your computer's graphics card. All scaling should be performed by BrightEye Mitto to ensure pixel size and shape are maintained properly.

Note: This applies to DVI only as Mitto detects the resolution of a DVI or HDMI signal but cannot detect the resolution of a VGA signal.

If you have set your computer's resolution to a certain value but Mitto reports a different resolution (for example, you have set your computer to 1920 x 1080 but Mitto is reporting 1680 x 1050), the graphics card may be overriding the resolution settings you have selected on your computer.

Check your computer's graphics card settings and turn off any scaling that the computer graphics card may be applying. Look for a tab that controls your graphics card. It may be referred to as something other than "scaling" such as "modify" depending on which controls are provided by the specific graphics card in your computer.

I do not understand how to configure Mitto to work with a laptop

To configure BrightEye Mitto to work with a laptop, set the laptop for use with an external monitor. To the laptop, Mitto is like an external monitor. The laptop needs to be told that it should feed a signal to an external device or monitor so that a signal can be fed to Mitto. Mitto is connected to the laptop in place of an external monitor.

Go to the computer's display settings menu. Select a setting that you would use for an external monitor, such as Mirror, Clone, Duplicate Monitor or something similar.

For further information about configuring Mitto, see Getting Started on page 10.

BrightEye Mitto is not converting VGA to DVI

As a point of clarification, BrightEye Mitto is not a VGA-to-DVI converter. The loop through output on the back of Mitto outputs the signal coming in on the DVI/VGA Input. If you input DVI, then DVI will be on the loop out. If you input VGA, then VGA will be on the loop out.

Using monitors that have HDMI input instead of DVI input with Mitto

Mitto treats HDMI and DVI signals the same. Connect an HDMI-to-DVI adaptor for use with Mitto.

SOFTWARE UPDATING

Software upgrades for BrightEyes are available at:

<http://www.ensembledesigns.com/support/brighteye-support/>

Use BrightEye Mac or PC software to install the software update into your BrightEye.

WARRANTY AND FACTORY SERVICE

Warranty

This module is covered by a five-year limited warranty, as stated in the main Preface of this manual. If you require service (under warranty or not), please contact Ensemble Designs and ask for customer service before you return the unit. This will allow the service technician an opportunity to provide any other suggestions for identifying the problem and to recommend possible solutions.

Factory Service

If you return equipment for repair, please get a Return Material Authorization Number (RMA) from the factory first.

Ship the product and a written description of the problem to:

Ensemble Designs, Inc.
Attention: Customer Service RMA #####
870 Gold Flat Rd.
Nevada City, CA. 95959 USA

(530) 478-1830
Fax: (530) 478-1832

service@ensembledesigns.com

<http://www.ensembledesigns.com>

Be sure to put your RMA number on the outside of the box.

SPECIFICATIONS

Computer Input

Number	One	Type	DVI
			(Supports HDMI or VGA with adapter)
Connector	DVI-I		
Resolution	Up to 1920 x 1200		

Reference Input

Number	One, BNC
Type	1 V P-P Composite Video PAL, NTSC, Tri-Level Sync
Impedance	75 Ω
Return Loss	>40 dB

Note: When no reference is provided, Mitto runs from an internal "sync gen grade" precision frequency reference.

Analog Audio Inputs

Number	One stereo pair
Connector	1/8" mini jack
Impedance	>15K Ω
Max Input Level	24 dBu
Quantization	24 bits, 128 x oversampled
Sample Rate	48 KHz
Reference Level	-10 dBu or +4 dBu
Frequency Response	± 0.1 dB, 20 Hz to 20 KHz
Crosstalk	<106 dB
Dynamic Range	>106 dB

AES/EBU Digital Inputs (BEM-1, BEM-1F, BEM-2)

Number	Two (four channels)
Type	AES3id, S/PDIF
Connector	1/8" mini jack
Bit Depth	20 and 24 Bit
Sample Rate	30 KHz to 192 KHz (Sample Rate Converted Internally to 48KHz)

Serial Digital Output

Number	Two, BNC One for BEM-1F
Signal Type	1.485 Gb/s HD, 270 Mb/s SD SDI 2.97 Gb/s HD (BEM-1, BEM-1F only)
Processing	16 bit processing 12 and 14 bit upconversion
Delay	Adjustable from 16 msec to 40 msec

Note: Output is fully timeable with respect to the reference input.

Audio Embedded

Impedance	75 Ω
Return Loss	>15 dB to 1.485 GHz >10 dB to 2.97 GHz
Output DC	None (AC coupled)

SDI Standards Supported

1080i (SMPTE 274M -4,5,6) 50, 59.94 or 60 Hz
 720p (SMPTE 296M -1,2,3) 50, 59.94 or 60 Hz
 525i, 625i (SMPTE 259M)

BEM-1 and BEM-1F also support:

1080p (SMPTE 274M -9,10,11) 23.98, 24, 25 Hz
 1080sF (RP211 -14,15,16) 23.98, 24, 25 Hz
 3 Gb/s Level A or Level B (SMPTE 424M, 425M)

Optical Output (BEM-1F)

Number	One, LC/UPC
Type	Follows SDI configuration Wavelength 1310 nm (non-CWDM) Wavelengths 170 nm –1610 nm at 20 nm CWDM spacing available. Call factory for price and details.
Power	-7 dBm
Max Cable Length	20 km (For greater distances, or higher power and larger loss budgets, please contact the factory)
Fiber Type	Single Mode Multi-mode compatible with 8 dB attenuation at transmit end

Analog Video Output

Number	One, BNC
Type	Composite PAL or NTSC (when SD is selected on the SDI output)
Return Loss	>40 dB
Output DC	<100 mV

Computer Monitor Output

Number	One, looping Type DVI (Supports HDMI or VGA with adapter)
Connector	DVI-I
Format	Follows input

Control

Number	One
Connector	9 pin D
Type	RS-232, GPI

General Specifications

Size	5.625" W x 1.7" H x 5.5" D (143 mm x 20 mm x 140 mm) including connectors
Weight	1 lb 6 oz
Power	12 volts, 12 watts (100-230 VAC modular power supply not included)
Temperature Range	0 to 40° C ambient
Relative Humidity	0 to 95° non-condensing

GLOSSARY

This is a brief glossary of commonly used terms associated with this product.

AES/EBU

The digital audio standard defined as a joint effort of the Audio Engineering Society and the European Broadcast Union. AES/EBU or AES3 describes a serial bit stream that carries two audio channels, thus an AES stream is a stereo pair. The AES/EBU standard covers a wide range of sample rates and quantizations (bit depths.) In television systems, these will generally be 48 kHz and either 20 or 24 bits.

Aspect Ratio

The ratio of the horizontal and vertical measurements of an image. 4:3 is the aspect ratio for standard definition video formats and television and 16:9 for high definition. Converting formats of unequal ratios is done by letter boxing (horizontal bars) or pillar boxing (vertical pillars) in order to keep the original format's aspect ratio.

Bandwidth

Strictly speaking, this refers to the range of frequencies (i.e., the width of the band of frequency) used by a signal, or carried by a transmission channel. Generally, wider bandwidth will carry and reproduce a signal with greater fidelity and accuracy.

Beta

Sony Beta SP video tape machines use an analog component format that is similar to SMPTE, but differs in the amplitude of the color difference signals. It may also carry setup on the luminance channel.

Blanking

The Horizontal and Vertical blanking intervals of a television signal refer to the time periods between lines and between fields. No picture information is transmitted during these times, which are required in CRT displays to allow the electron beam to be repositioned for the start of the next line or field. They are also used to carry synchronizing pulses which are used in transmission and recovery of the image. Although some of these needs are disappearing, the intervals themselves are retained for compatibility purposes. They have turned out to be very useful for the transmission of additional content, such as teletext and embedded audio.

CAV

Component Analog Video. This is a convenient shorthand form, but it is subject to confusion. It is sometimes used to mean ONLY color difference component formats (SMPTE or Beta), and other times to include RGB format. In any case, a CAV signal will always require 3 connectors – either Y/R-Y/B-Y, or R/G/B.

Checkfield

A Checkfield signal is a special test signal that stresses particular aspects of serial digital transmission. The performance of the Phase Locked-Loops (PLLs) in an SDI receiver must be able to tolerate long

runs of 0's and 1's. Under normal conditions, only very short runs of these are produced due to a scrambling algorithm that is used. The Checkfield, also referred to as the Pathological test signal, will "undo" the scrambling and cause extremely long runs to occur. This test signal is very useful for testing transmission paths.

Chroma

The color or chroma content of a signal, consisting of the hue and saturation of the image. See also Color Difference.

Component

In a component video system, the totality of the image is carried by three separate but related components. This method provides the best image fidelity with the fewest artifacts, but it requires three independent transmission paths (cables). The commonly used component formats are Luminance and Color Difference (Y/Pr/Pb), and RGB. It was far too unwieldy in the early days of color television to even consider component transmission.

Composite

Composite television dates back to the early days of color transmission. This scheme encodes the color difference information onto a color subcarrier. The instantaneous phase of the subcarrier is the color's hue, and the amplitude is the color's saturation or intensity. This subcarrier is then added onto the existing luminance video signal. This trick works because the subcarrier is set at a high enough frequency to leave spectrum for the luminance information. But it is not a seamless matter to pull the signal apart again at the destination in order to display it or process it. The resultant artifacts of dot crawl (also referred to as chroma crawl) are only the most obvious result. Composite television is the most commonly used format throughout the world, either as PAL or NTSC. It is also referred to as Encoded video.

Color Difference

Color Difference systems take advantage of the details of human vision. We have more acuity in our black and white vision than we do in color. This means that we need only the luminance information to be carried at full bandwidth, we can scrimp on the color channels. In order to do this, RGB information is converted to carry all of the luminance (Y is the black and white of the scene) in a single channel. The other two channels are used to carry the "color difference". Noted as B-Y and R-Y, these two signals describe how a particular pixel "differs" from being purely black and white. These channels typically have only half the bandwidth of the luminance.

Decibel (dB)

The decibel is a unit of measure used to express the ratio in the amplitude or power of two signals. A difference of 20 dB corresponds to a 10:1 ratio between two signals, 6 dB is approximately a 2:1 ratio. Decibels add while the ratios multiply, so 26 dB is a 20:1 ratio, and 14 dB is a 5:1 ratio. There are several special cases of the dB scale, where the reference is implied. Thus, dBm refers to power relative to 1 milliwatt, and dBu refers to voltage relative to .775V RMS. The original unit of measure was the Bel (10 times bigger), named after Alexander Graham Bell.

dBFS

In Digital Audio systems, the largest numerical value that can be represented is referred to as Full Scale. No values or audio levels greater than FS can be reproduced because they would be clipped. The nominal operating point (roughly corresponding to 0 VU) must be set below FS in order to have headroom for audio peaks. This operating point is described relative to FS, so a digital reference level of -20 dBFS has 20 dB of headroom before hitting the FS clipping point.

DVI

Digital Visual Interface. DVI-I (integrated) provides both digital and analog connectivity. The larger group of pins on the connector are digital while the four pins on the right are analog.

EDH

Error Detection and Handling is a method to verify proper reception of an SDI or HD SDI signal at the destination. The originating device inserts a data packet in the vertical interval of the SDI signal and every line of the HD signal which contains a checksum of the entire video frame. This checksum is formed by adding up the numerical values of all of the samples in the frame, using a complex formula. At the destination this same formula is applied to the incoming video and the resulting value is compared to the one included in the transmission. If they match, then the content has all arrived with no errors. If they don't, then an error has occurred.

Embedded Audio

Digital Audio can be carried along in the same bit stream as an SDI or HD SDI signal by taking advantage of the gaps in the transmission which correspond to the horizontal and vertical intervals of the television waveform. This technique can be very cost effective in transmission and routing, but can also add complexity to signal handling issues because the audio content can no longer be treated independently of the video.

Frame Sync

A Frame Synchronizer is used to synchronize the timing of a video signal to coincide with a timing reference (usually a color black signal that is distributed throughout a facility). The synchronizer accomplishes this by writing the incoming video into a frame buffer memory under the timing direction of the sync information contained in that video. Simultaneously the memory is being read back by a timing system that is genlocked to a house reference. As a result, the timing or alignment of the video frame can be adjusted so that the scan of the upper left corner of the image is happening simultaneously on all sources. This is a requirement for both analog and digital systems in order to perform video effects or switch glitch-free in a router. Frame synchronization can only be performed within a single television line standard. A synchronizer will not convert an NTSC signal to a PAL signal; it takes a standards converter to do that.

Frequency Response

A measurement of the accuracy of a system to carry or reproduce a range of signal frequencies. Similar to Bandwidth.

HDMI

The High Definition Multimedia Interface comes to us from the consumer marketplace where it is becoming the de facto standard for the digital interconnect of display devices to audio and video sources. It is an uncompressed, all-digital interface that transmits digital video and eight channels of digital audio. HDMI is a bit serial interface that carries the video content in digital component form over multiple twisted-pairs. HDMI is closely related to the DVI interface for desktop computers and their displays.

IEC

The International Electrotechnical Commission provides a wide range of worldwide standards. They have provided standardization of the AC power connection to products by means of an IEC line cord. The connection point uses three flat contact blades in a triangular arrangement, set in a rectangular connector. The IEC specification does not dictate line voltage or frequency. Therefore, the user must take care to verify that a device either has a universal input (capable of 90 to 230 volts, either 50 or 60 Hz), or that a line voltage switch, if present, is set correctly.

Interlace

Human vision can be fooled to see motion by presenting a series of images, each with a small change relative to the previous image. In order to eliminate the flicker, our eyes need to see more than 30 images per second. This is accomplished in television systems by dividing the lines that make up each video frame (which run at 25 or 30 frames per second) into two fields. All of the odd-numbered lines are transmitted in the first field, the even-numbered lines in the second field. In this way, the repetition rate is 50 or 60 Hz, without using more bandwidth. This trick has worked well for years, but it introduces other temporal artifacts. Motion pictures use a slightly different technique to raise the repetition rate from the original 24 frames that occur each second—they just project each one twice.

IRE

Video level is measured on the IRE scale, where 0 IRE is black, and 100 IRE is full white. The actual voltages that these levels correspond to can vary between formats.

ITU-R 601

This is the principal standard for standard definition component digital video. It defines the luminance and color difference coding system that is also referred to as 4:2:2. The standard applies to both PAL and NTSC derived signals. They both will result in an image that contains 720 pixels horizontally, with 486 vertical pixels in NTSC, and 576 vertically in PAL. Both systems use a sample clock rate of 27 Mhz, and are serialized at 270 Mb/s.

Jitter

Serial digital signals (either video or audio) are subject to the effects of jitter. This refers to the instantaneous error that can occur from one bit to the next in the exact position of each digital transition. Although the signal may be at the correct frequency on average, in the interim it varies. Some bits come slightly early, other come slightly late. The measurement of this jitter is given either as the amount of time uncertainty or as the fraction of a bit width. For 270 Mb/s video, the allowable jitter is 740 picoseconds, or 0.2 UI (Unit Interval – one bit width).

Luminance

The “black & white” content of the image. Human vision has more acuity in luminance, so television systems generally devote more bandwidth to the luminance content. In component systems, the luminance is referred to as Y.

Multi-mode

Multi-mode optical fibers have a larger diameter core (either 50 or 62.5 microns), and a correspondingly larger aperture. It is much easier to couple light energy into a multi-mode fiber, but internal reflections will cause multiple “modes” of the signal to propagate down the fiber. This will degrade the ability of the fiber to be used over long distances.

See also Single mode.

NTSC

The color television encoding system used in North America was originally defined by the National Television Standards Committee. This American standard has also been adopted by Canada, Mexico, Japan, Korea, and Taiwan. (This standard is referred to disparagingly as Never Twice Same Color.)

Optical

An optical interface between two devices carries data by modulating a light source. This light source is typically a laser or laser diode (similar to an LED) which is turned on and off at the bit rate of the data stream. The light is carried from one device to another through a glass fiber. The fiber’s core acts as a waveguide or lightpipe to carry the light energy from one end to another. Optical transmission has two very significant advantages over metallic copper cables. Firstly, it does not require that the two endpoint devices have any electrical connection to each other. This can be very advantageous in large facilities where problems with ground loops appear. And secondly, and most importantly, an optical interface can carry a signal for many kilometers or miles without any degradation or loss in the recovered signal. Copper is barely useful at distances of just 1000 feet.

Oversampling

A technique to perform digital sampling at a multiple of the required sample rate. This has the advantage of raising the Nyquist Rate (the maximum frequency which can be reproduced by a given sample rate) much higher than the desired passband. This allows more easily realized anti-aliasing filters.

PAL

During the early days of color television in North America, European broadcasters developed a competing system called Phase Alternation by Line. This slightly more complex system is better able to withstand the differential gain and phase errors that appear in amplifiers and transmission systems. (Engineers at the BBC claim that it stands for Perfection At Last.)

Progressive

An image scanning technique which progresses through all of the lines in a frame in a single pass. Computer monitors all use progressive displays. This contrasts to the interlace technique common to

television systems.

Return Loss

An idealized input or output circuit will exactly match its desired impedance (generally 75 ohms) as a purely resistive element, with no reactive (capacitive or inductive) elements. In the real world we can only approach the ideal. So our real inputs and outputs will have some capacitance and inductance. This will create impedance matching errors, especially at higher frequencies. The Return Loss of an input or output measures how much energy is returned (reflected back due to the impedance mismatch). For digital circuits, a return loss of 15 dB is typical. This means that the energy returned is 15 dB less than the original signal. In analog circuits, a 40 dB figure is expected.

RGB

RGB systems carry the totality of the picture information as independent Red, Green, and Blue signals. Television is an additive color system, where all three components add to produce white. Because the luminance (or detail) information is carried partially in each of the RGB channels, all three must be carried at full bandwidth in order to faithfully reproduce an image.

Sch Phase

Used in composite systems, Sch Phase measures the relative phase between the leading edge of sync on line 1 of field 1 and a continuous subcarrier sinewave. Due to the arithmetic details of both PAL and NTSC, this relationship is not the same at the beginning of each frame. In PAL, the pattern repeats every 4 frames (8 fields) which is also known as the Bruch Blanking sequence. In NTSC, the repeat is every 2 frames (4 fields). This creates enormous headaches in editing systems and the system timing of analog composite facilities.

SDI

Serial Digital Interface. This term refers to inputs and outputs of devices that support serial digital component video. This could refer to standard definition at 270 Mb/s, HD SDI or High Definition Serial Digital video at 1.485 Gb/s, or to the newer 3G standard of High Definition video at 2.97 Gb/s.

SMPTE

The Society of Motion Picture and Television Engineers is a professional organization which has done tremendous work in setting standards for both the film and television industries. The term "SMPTE" is also shorthand for one particular component video format—luminance and color difference.

Single mode

A Single mode (or monomode) optical fiber carries an optical signal on a very small diameter (9 micron) core surrounded with cladding. The small diameter means that no internally reflected lightwaves will be propagated. Thus only the original "mode" of the signal passes down the fiber. A single mode fiber used in an optical SDI system can carry a signal for up to 20 kilometers. Single mode fibers require particular care in their installation due to the extremely small optical aperture that they present at splice and connection points.

See also Multi-mode.

TBC

A Time Base Corrector is a system to reduce the Time Base Error in a signal to acceptable levels. It accomplishes this by using a FIFO (First In, First Out) memory. The incoming video is written into the memory using its own jittery timing. This operation is closely associated with the actual digitization of the analog signal because the varying position of the sync timing must be mimicked by the sampling function of the analog to digital converter. A second timing system, genlocked to a stable reference, is used to read the video back out of the memory. The memory acts as a dynamically adjusting delay to smooth out the imperfections in the original signal's timing. Very often a TBC will also function as a Frame Synchronizer.

See also: Frame Sync.

Time Base Error

Time base error is present when there is excessive jitter or uncertainty in the line-to-line output timing of a video signal. This is commonly associated with playback from video tape recorders, and is particularly severe with consumer type heterodyne systems like VHS. Time base error will render a signal unusable for broadcast or editing purposes.

Tri-Level Sync

An analog sync reference signal that is used in High Definition systems. Tri-Level Sync is constructed with three signal levels, the sync pulses extend above and below a mid-level average voltage (the blanking level). Unlike conventional analog sync which is bi-level, the proper 50% pickoff point is already identified in Tri-Level Sync. This contributes to lower jitter in digital systems.

VGA

Video Graphics Array. Traditional 15-pin, analog interface between a PC and monitor.

YUV

Strictly speaking, YUV does not apply to component video. The letters refer to the Luminance (Y), and the U and V encoding axes used in the PAL composite system. Since the U axis is very close to the B-Y axis, and the V axis is very close to the R-Y axis, YUV is often used as a sort of shorthand for the more long-winded "Y/R-Y/B-Y".

Y/Cr/Cb

In digital component video, the luminance component is Y, and the two color difference signals are Cr (R-Y) and Cb (B-Y).

Y/Pr/Pb

In analog component video, the image is carried in three components. The luminance is Y, the R-Y color difference signal is Pr, and the B-Y color difference signal is Pb.