



BrightEye NXT 410, 410-H, 415 & 430 Compact Routers 3G/HD/SD/HDMI

Installation, Configuration and Operations Guide



Revision 1.2 SW v2.0.0

ENSEMBLE
DESIGNS

Purveyors of Fine Video Gear—Loved by Engineers Worldwide

Clearly, Ensemble wants to be in the broadcast equipment business. It's so rare anymore to find a company of this caliber that has not been gobbled up by a large corporation. They are privately held so they don't have to please the money people. They really put their efforts into building products and working with customers.

I'm really happy with the BrightEye products and Ensemble's service, and even more important my engineers are happy. We've continued to upgrade the product and add more cards. We will be rebuilding our production control room and we will use BrightEye again.

~ Don McKay, Vice President Engineering, Oregon Public Broadcasting

Who is Ensemble Designs?

By Engineers, For Engineers

In 1989, a former television station engineer who loved designing and building video equipment, decided to start a new company. He relished the idea of taking an existing group of equipment and adding a few special pieces in order to create an even more elegant ensemble. So, he designed and built his first product and the company was born.



BrightEye frames handle 270 Mb/s, 1.5 Gb/s and 3 Gb/s signals, audio and MPEG signals. Used worldwide in broadcast, mobile, production, and post.

Focused On What You Need

As the company has grown, more former TV station engineers have joined Ensemble Designs and this wealth of practical experience fuels the company's innovation. Everyone at the company is focused on providing the very equipment you need to complete your ensemble of video and audio gear. We offer those special pieces that tie everything together so that when combined, the whole ensemble is exactly what you need.

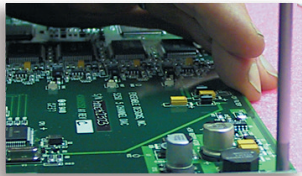

We're focused on processing gear—3G/HD/SD/ASI video, audio and optical units.

Notably Great Service for You

We listen to you – just tell us what you need and we'll do our best to build it. We are completely focused on you and the equipment you need. Being privately held means we don't have to worry about a big board of directors or anything else that might take attention away from real business. And, you can be sure that when you call a real person will answer the phone. We love this business and we're here to stay.



Come on by and visit us. Drop in for lunch and a tour!

Bricks and Mortar of Your Facility

The bricks and mortar of a facility include pieces like up/downconverters, audio embedders, video converters, routers, protection switches and SPGs for SD, HD and 3 Gb/s. That's what we're focused on, that's all we do – we make proven and reliable signal processing and infrastructure gear for broadcasters worldwide, for you.



Shipped with care to television broadcasters and video facilities all over the world.



Contents

Preface	11
Document Organization at a Glance	11
Chapter 1: Introduction	12
In this Chapter	12
Purpose of Document	12
Intended Audience	12
Introductory Videos	13
Additional Resources	14
Chapter 2: System Overview	15
In this Chapter	15
Features	15
Clean Switching between Asynchronous Sources	16
Assignable I/O and Flexible Architecture	16
Signal Diagnostics	16
Ethernet Connectivity and Long Distances	16
Front Panel Controls	17
Rear Connectors	18
BrightEye NXT 410 and 410-H Clean HDMI Compact Routers	18
BrightEye NXT 415 and 430 Compact Routers	19
Default Port Configuration as Shipped from the Factory	20
<i>410 and 410-H Default Port Configuration</i>	20
<i>415 and 430 Default Port Configuration</i>	20
Applications	21
Cuts-Only Master Control	21
Quality Control and Signal Monitoring	22
Multi-Stage Venue	22
Monitors and Projectors for Venues	23

Chapter 3: Installation	24
In this Chapter	24
Connecting Cables to Ports	24
Connecting a Reference If Needed	24
Connecting the Power Supply	25
Connecting Ethernet for Web Control Point (Optional)	25
RS-232 Interface Option	25
Chapter 4: Configuration	26
In this Chapter	26
Router Configuration Menus	27
Menus Accessed from the Front Panel	27
Configuration Controls	28
<i>Configuration Button</i>	28
<i>Navigation Buttons</i>	28
<i>Information Button</i>	28
Front Panel Navigation	28
Menus Accessed from the Web Interface	29
Assigning Shortcut Buttons	30
About Port Configuration	31
Planning Router Port Configuration	31
Cabling Router and Configuring Ports to Match Plan	31
Definitions of Port Configuration Choices	31
<i>Unassigned</i>	31
<i>Source</i>	31
<i>Destination</i>	31
<i>Follow</i>	31
<i>Primary TSG</i>	32
<i>Secondary TSG</i>	32
Port Configuration Choices Available According to Port Type	33
<i>For Fixed Input</i>	33
<i>For Fixed Output</i>	33
<i>For Bi-Directional</i>	33

Configuring the Router's Ports from the Front Panel	34
Assigning Ports	34
<i>To Assign Ports</i>	34
Renaming Ports	34
<i>To Rename a Port</i>	35
Adjusting Audio Levels	35
<i>To Adjust Audio Levels</i>	35
Mapping Audio Channels	36
<i>To Remap Audio Channels</i>	36
Configuring the Router's Ports from the Web Interface	37
Assigning and Naming Ports	37
<i>To Assign and Name Ports</i>	37
Adjusting Audio Levels	38
<i>To Adjust Audio Levels</i>	38
Mapping Audio Channels	39
<i>To Remap Audio Channels</i>	39
About Clean Switches and Clean Switch Configuration	40
Genlocked to Reference	40
Embedded Audio	40
Output Port Following a Clean Switched Destination	40
Clean Switch Output Timing	40
Imposing Delay on a Video Signal	41
Pre-Selector to a Production Switcher	41
Feeding On-Set Monitors in a Live Environment	41
Configuring Clean Switches from the Front Panel	42
To Assign a Clean Switch to a Destination	42
To Set the Standard for Clean Switches	42
To Set the Output Timing for Clean Switches	43
To Set the Audio Enables for Clean Switches	43
To Set Audio Breakaway	44
Configuring Clean Switches from the Web Interface	45
To Assign a Clean Switch to a Destination	46
To Set the Standard for Clean Switches	46

To Set the Output Timing for Clean Switches	47
To Set the Audio Enables for Clean Switches	47
To Set the Audio Breakaway for Clean Switches	47
Setting Up Timing and Genlock	48
To Select the Reference Source from the Front Panel	48
<i>System Frame Rate</i>	48
<i>Vertical Interval Switch Point</i>	48
To Select the Reference Source from the Web Interface	49
Note on Frame Rates	49
50 Hz	49
59.94 Hz	49
60 Hz	49
Working with the Internal Test Signal Generators	50
Configuring the Internal Test Signal Generators from the Front Panel	50
<i>To Select the TSG Standard</i>	51
<i>To Select the TSG Pattern</i>	51
<i>To Set the TSG Vertical Timing</i>	52
<i>To Set the TSG Horizontal Timing</i>	52
<i>To Configure the TSG Slate</i>	53
<i>To Configure the TSG Slate Text</i>	53
<i>To Configure the TSG Cyclops</i>	54
<i>To Configure the TSG Audio Reference Level</i>	54
<i>To Configure the TSG Audio Enables</i>	55
<i>To Configure the TSG Audio Channels</i>	56
Configuring the Internal Test Signal Generators from the Web Interface	57
<i>Standard</i>	58
<i>Pattern</i>	58
<i>Vertical and Horizontal Timing</i>	59
<i>Audio Embedding</i>	59
<i>Audio Reference Level</i>	60
<i>Audio Group Enable</i>	60
<i>Audio Source Selection</i>	60
<i>Slate On</i>	61
<i>Slate Text</i>	61
<i>Cyclops</i>	61

Setting Up a Web Control Point (Optional)	62
Connecting an Ethernet Cable	62
Assigning the BrightEye NXT a New IP Address and Subnet Mask	62
<i>To Set the IP Address</i>	62
<i>To Set the Subnet Mask</i>	63
<i>Gateway and DNS Server Settings</i>	63
Requesting the Web Control Point	64
Assigning the Default Profile to the Web Control Point	66
Establishing Additional Web Control Points and Access Authentication	68
Characteristics of Control Points	68
Examples of Control Points	68
Configuring Additional Control Points	69
<i>First Method: Requesting Access from a Desired Control Point</i>	69
<i>Second Method: Assigning an IP Address From the Admin Control Point</i>	69
Approving Pending Authorizations	69
Number of Control Points That Can Operate Simultaneously	70
<i>Asymmetrical Bandwidth Requirements</i>	70
<i>Best Practice: Closing Web Browser Control Points When Not In Use</i>	70
Creating and Editing Profiles	71
Characteristics of Profiles	71
Creating an Initial Set of Profiles	71
<i>To Create a Profile</i>	71
Examples of Profiles	72
<i>Master Control Room (MCR) 10 x 2</i>	72
<i>MCR Profile Edited and Reordered to 8 x 2</i>	73
<i>MCR Profile Edited to 8 x 1</i>	74
Setting Up Salvos	75
To Create a Salvo	75
<i>First Method</i>	75
<i>Second Method</i>	76
Security and Administrative Access to Settings	78
To Limit Access to the Router's Settings	78

Saving and Restoring Configuration Settings	79
To Save Configuration Settings	79
To Upload Configuration Settings	79
Chapter 5: Operations and Step-by-Step Procedures	81
In this Chapter	81
Operations Using the Front Control Panel	81
Making a Cross Point Switch in Preset/Take Panel Mode	81
<i>Selecting a Destination</i>	81
<i>Selecting a Source</i>	81
<i>Pressing Take</i>	82
Performing Direct Takes	82
<i>To Enter Direct Take Panel Mode</i>	82
<i>To Make a Direct Take</i>	82
<i>To Exit Direct Take Panel Mode</i>	82
Performing Mix Takes with the Front Panel	83
<i>Clean Switch Required</i>	83
<i>To Enter Mix Mode</i>	83
<i>To Make a Mix Take</i>	83
<i>To Exit Mix Mode</i>	83
Viewing Information about a Routed Signal	84
Disabling the Front Panel for Safe Driving Mode	84
<i>To Enter Safe Driving Mode</i>	84
Operations Using a Web Control Point	85
Prerequisites	85
Accessing the Web Browser Control Interface	85
Performing Takes	85
<i>To Perform a Take by Selecting a Source and a Destination</i>	85
<i>To Perform a Take by Selecting Only a New Source</i>	85
Performing Direct Takes	86
<i>To Perform a Direct Take</i>	86
<i>To Exit Direct Take Mode</i>	86
Performing Gang Takes	87
<i>To Perform a Gang Take</i>	87
<i>To Exit Gang Mode</i>	87

Performing Direct Gang Takes	87
<i>To Perform a Direct Gang Take</i>	87
<i>To Exit Direct Gang Mode</i>	87
Performing Mix Takes	88
<i>Clean Switch Required</i>	88
<i>To Perform a Mix Take</i>	88
Keyboard Shortcuts for the Web Interface	89
<i>Selecting Sources</i>	89
<i>Selecting Destinations</i>	89
<i>Performing a Take</i>	89
<i>Performing a Mix</i>	89
<i>Performing a Direct Take</i>	89
<i>Gang Selections</i>	89
Using Salvos	90
<i>To Perform a Salvo</i>	90
<i>Salvo Keyboard Shortcuts</i>	90
Display Preferences	91
Chapter 6: External Control	92
The BrightEye NXT's Approach to Control Integration	92
RS-232 Interface Option	92
9-Pin D Connector Pin Out	92
Supported Control Protocols Overview	92
Software Development Kit (SDK)	93
Accessing Features Unique to the BrightEye NXT Compact Routers	93
Configuring External Control	94
Automation Protocols	95
Introduction	95
Conventions	95
Overview	96
Before You Begin	96
Understanding Profiles	97
Configuration	99
<i>Profile Configuration</i>	100
<i>External Control Configuration</i>	100

Protocols	101
<i>GV TEN-XL ASCII Protocol</i>	101
<i>GV Performer ASCII Protocol</i>	105
<i>Generic ASCII Protocol</i>	110
Chapter 7: Maintenance and Troubleshooting	118
Switching Signals Does Not Occur Smoothly	118
Cannot Connect to the BrightEye NXT from a Web Browser	118
Supported Browsers	118
The Take Button is Grayed Out	119
Resetting to Factory Default Settings	119
Software Updating	119
Warranty and Factory Service	120
Warranty	120
Factory Service	120
Specifications	121
For BrightEye NXT 410 Clean HDMI Router	121
For BrightEye NXT 415 and 430 Compact Routers	122
Glossary	123

Preface

Document Organization at a Glance

This manual addresses all of the essential topics for understanding how to install, configure and use the BrightEye NXT 410, 410-H, 415 and 430 Compact Routers. See the following table for a quick glance at what each chapter addresses. Note that the items in the main table of contents, as well as the chapter titles below, are links.

Chapter Title	Topics Covered
Chapter 1: Introduction	A brief introduction to this document and to the BrightEye NXT Router with links to additional resources such as training videos.
Chapter 2: System Overview	Describes the overall BrightEye NXT Router system—its hardware and software components and example applications.
Chapter 3: Installation	This chapter describes the cable connections needed.
Chapter 4: Configuration	Addresses configuration menus for the front panel and the web interface; assigning shortcut buttons; configuring ports; working with clean switches; audio level adjustments; audio channel mapping; setting up timing and genlock; configuring internal test signal generators; setting up a web control point (optional); establishing additional web control points and access authentication; creating and editing profiles; downloading and uploading configuration settings; and security and administrative access to settings.
Chapter 5: Operations and Step-by-Step Procedures	After the BrightEye NXT Router has been installed and configured, it is ready to use. This chapter addresses all of the standard operational tasks of the BrightEye NXT Router that you can perform using the front panel and web browser interface. Operational tasks include performing takes, direct takes, mix takes, gang takes, direct gang takes, and accessing ancillary data.
Chapter 6: External Control	Addresses how the BrightEye NXT handles external control integration; supported control protocols; SNMP Interface; RS-232 interface option.
Chapter 7: Maintenance and Troubleshooting	This chapter addresses possible issues that new users may encounter while becoming familiar with the BrightEye NXT Router.
Specifications	Presents standard specifications for the BrightEye NXT Router regarding inputs, max cable length, outputs and reference.
Glossary	Includes definitions of commonly-used terms relevant to the video broadcast industry.

Chapter 1: Introduction

In this Chapter

This chapter addresses the following topics:

- [Purpose of Document](#)
- [Intended Audience](#)
- [Introductory Videos](#)
- [Additional Resources](#)

Purpose of Document

This Installation, Configuration and Operations Guide supports the process of planning for, installing, configuring and operating the Ensemble Designs BrightEye NXT 410, 415 and 430 Compact Routers.

This manual describes the elements of the system, how they work together, and the practical aspects of working with the Router to meet your facility's needs.

Use the Contents and the [Preface](#) to quickly link to a specific chapter or topic.

Intended Audience

In addition to the target audience listed below, this document is meant for anyone who needs to target a specific area of functionality in order to meet an immediate need, as well as for those who need to have a comprehensive understanding of the Router from a systems planning point of view.

The intended audience for this manual includes people with the following roles:

- studio designers
- broadcast engineers
- installation and configuration personnel
- router operators

Introductory Videos

The BrightEye NXT products can be configured with various options and in different sizes to address a wide variety of applications. Please view the two brief videos below for an overview of the BrightEye NXT 430 Compact Router by Technology Evangelist John Pichitino and Marketing Czar Cindy Zuelsdorf, and the BrightEye NXT 410 Clean HDMI Router by Director of Sales Mondae Hott and Engineer Chris Merrick.



John Pichitino and Cindy Zuelsdorf talking about the new BrightEye NXT 430 Compact Router. Note that the photograph is a link to a video on the Ensemble Designs website.



Mondae Hott and Chris Merrick talking about the new BrightEye NXT 410 Clean HDMI Router. Note that the photograph is a link to a video on the Ensemble Designs website.

Additional Resources

In addition to this document, please refer to these resources:

- [BrightEye NXT Routers Quick Start Guide](#)
- [BrightEye NXT Training Videos](#)
- [BrightEye NXT 430 Compact Router Demo at NAB 2014](#)
- [BrightEye NXT Router Family Brochure](#)
- [BrightEye NXT 430 and NXT 415 Compact Routers product page](#) from the Ensemble Designs web site
- [BrightEye NXT 410 Clean HDMI Router product page](#) from the Ensemble Designs web site

Chapter 2: System Overview

In this Chapter

This chapter addresses the following topics:

- [Features](#)
- [Clean Switching between Asynchronous Sources](#)
- [Assignable I/O and Flexible Architecture](#)
- [Signal Diagnostics](#)
- [Ethernet Connectivity and Long Distances](#)
- [Front Panel Controls](#)
- [Rear Connectors](#)
- [Applications](#)

Features

- Routing for 3G, HD, SD video (410 also works with HDMI)
- LCD display with realtime full motion video (can be disabled for safe driving mode for cars)
- Flexible I/O. Independently assign BNCs and SFPs as Inputs or Outputs
- Clean Switching of video and embedded audio (410 and 430)
- Passes embedded audio
- Audio level adjustments on a per input source and per channel basis when the signal is output through a Clean Switch
- Mix and Direct Take modes
- Two built-in Test Signal Generators
- Front Panel and Web-Based Control
- Genlockable and Timeable
- Eight Salvo Registers, includes the choice of Cut or Mix transition and transition duration
- Ability to Save/Restore the entire configuration of the product as a data file on a computer. Use to replicate the same overall configuration to multiple NXT routers
- TCP/IP Interface for Networking and Control
- RS-232 Interface Option
- Compact and Rugged
- 5-Year Warranty and Free Software Upgrades

Clean Switching between Asynchronous Sources

The BrightEye NXT 410 Clean HDMI Router and the BrightEye NXT 430 Clean Router provide clean, quiet switching of video and audio sources. Both units have two clean switched outputs, providing full frame synchronization.

Assignable I/O and Flexible Architecture

The BrightEye NXT 415 and BrightEye NXT 430 have 2 fixed input BNCs, 2 fixed output BNCs and 7 independently assignable BNCs that can be configured as inputs or outputs. The two SFP (small format pluggable) cages can be populated with dual SFPs that have fiber optic or other connectors.

The BrightEye NXT 410 has 2 fixed input BNCs, 2 fixed output BNCs, and 1 assignable BNC that can be configured as an input or an output. There are also 4 fixed input HDMI ports, 1 fixed output HDMI port, and 1 SFP cage that can be populated with dual SFPs.

Signal Diagnostics

Circuitry on every BrightEye NXT unit detects and measures key parameters associated with each video source, such as synchronicity and timing, line and frame rate, embedded audio presence or absence, closed caption information, and timecode data. These parameters can be displayed on both the front panel LCD screen and on web interface control points.

Ethernet Connectivity and Long Distances

Because the web interface connects to the BrightEye NXT Router over Ethernet, and because Ethernet reaches much farther than coaxial cable, BrightEye NXT Router web interface control points can be physically located very far away from the BrightEye NXT Router if desired.

For example, if you need the capability to select sources at the transmitter remotely, such as in the event of either a master control switcher failure or a microwave link failure between the studio and the transmitter, you can use the BrightEye NXT Router as part of a backup switcher at the transmitter. Sources such as a network feed, a small server or a weather camera could be switched to air in an emergency.

Front Panel Controls

All three models of the Router—the BrightEye NXT 410 Clean HDMI Router, the BrightEye NXT 415 Router and the BrightEye NXT 430 Clean Router—share the same front panel shown below.



Rear Connectors

BrightEye NXT 410 and 410-H Clean HDMI Compact Routers

The BrightEye NXT 410 Clean HDMI Router provides clean, quiet switching of HDMI and SDI video and audio sources. Model 410-H accepts HDCP-encrypted content. The front panel LCD displays realtime full motion video of your router sources. Feed the BrightEye NXT 410 with cameras and other HDMI sources and take the output to projectors, flat screens and production equipment. The built-in frame synchronizer provides two assignable clean switched outputs. Perform dissolves and direct takes from the front panel, or with the web browser interface using a computer, tablet or smartphone. Audio breakaway, audio level adjustments, and audio channel mapping offer routing flexibility in live applications. Save the entire configuration of the NXT as a data file. Upload saved settings to replicate the same overall configuration to multiple NXT routers.

With both HDMI and SDI inputs and outputs, you can integrate and switch signals from all types of equipment, regardless of the video format. Cameras with HDMI outputs can be used directly alongside SDI sources, and routed to either HDMI or SDI outputs. The SFP (small format pluggable) cage can be populated with dual SFPs that have fiber optic or other connectors, providing the ability to combine electrical BNC, HDMI and fiber optic inputs and outputs.

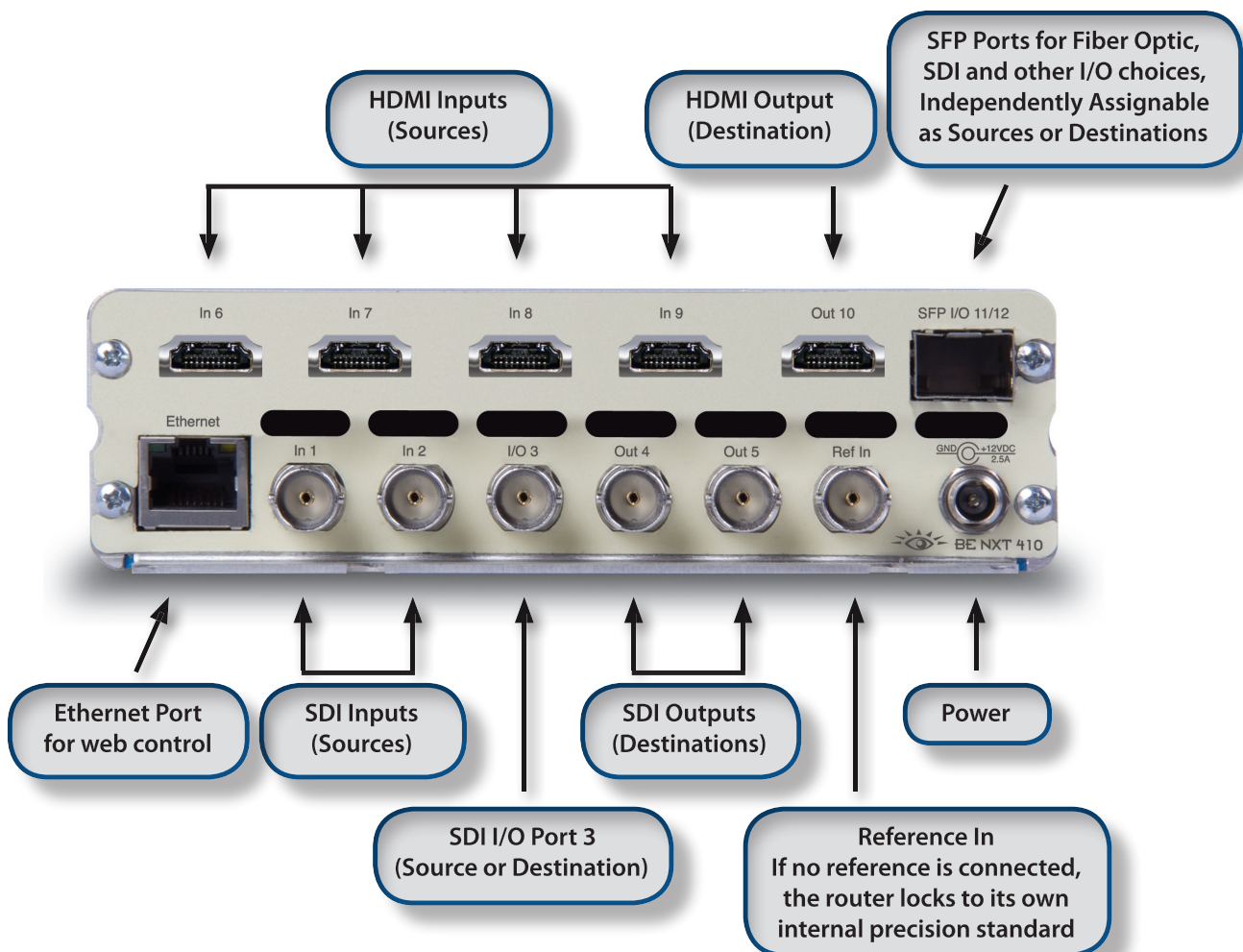

BrightEye NXT 415 and 430 Compact Routers

The BrightEye NXT 430 Router provides clean, quiet switching of video and audio sources. The front panel LCD displays realtime full motion video of your router sources. The BrightEye NXT 430 Router gives you two assignable clean switched outputs. The 430's built-in clean switch provides full frame synchronization which means you can switch cleanly between asynchronous sources. Perform dissolves and direct takes from the front panel, or with the web browser interface using a computer, tablet or smartphone. Audio breakaway, audio level adjustments, and audio channel mapping offer routing flexibility in live applications. Save the entire configuration of the NXT as a data file. Upload saved settings to replicate the same overall configuration to multiple NXT routers.

The number of inputs and outputs is configurable. There are 2 fixed input BNCs, 2 fixed output BNCs and 7 independently assignable BNCs that you configure either as inputs or outputs. The two SFP (small format pluggable) cages can be populated with dual SFPs that have fiber optic or other connectors, allowing you to determine the best connector for your installation. Adding SFPs gives you flexibility in combining electrical BNC and fiber optic inputs and outputs.

The BrightEye NXT 415 Router has all the capability of the 430, except it does not have clean switched outputs or audio breakaway.

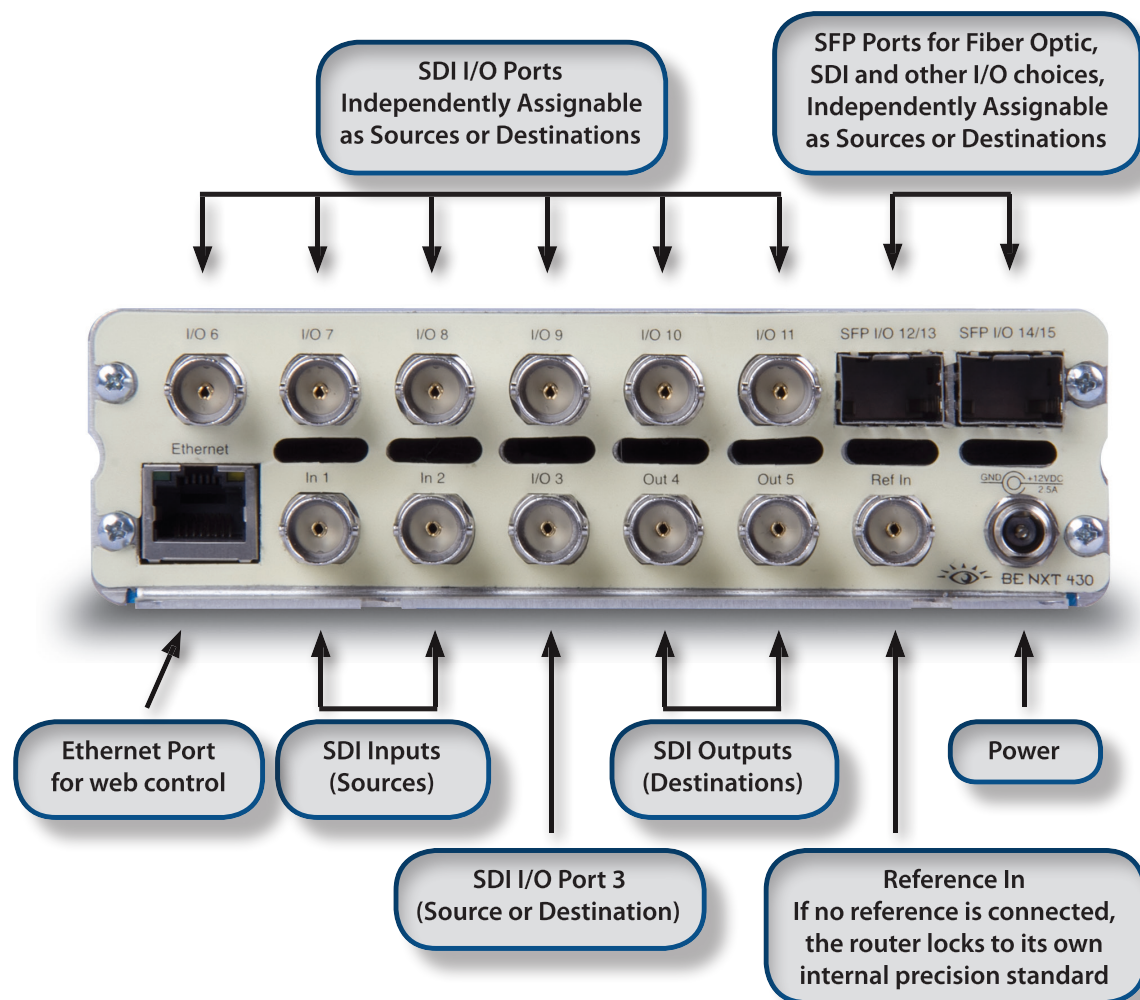

Default Port Configuration as Shipped from the Factory

410 and 410-H Default Port Configuration

Ports that are Unassigned, such as Port 3, can be configured from the front panel either as a Source or Destination, as described on page 34. The two Clean Switches (CS) can be assigned to Destinations as described on page 42.

In 1: Source	In 6: Source	SFP I/O 11: Unassigned
In 2: Source	In 7: Source	SFP I/O 12: Unassigned
I/O 3: Unassigned	In 8: Source	TSG 1: Source
Out 4: Destination	In 9: Source	TSG 2: Source
Out 5: Destination	Out 10: Destination	CS 1: Unassigned
		CS 2: Unassigned

415 and 430 Default Port Configuration

The default port configurations for the BrightEye NXT 415 and 430 are shown below. Ports that are Unassigned, such as Port 3, can be configured from the front panel either as a Source or Destination, as described on page 34. The two Clean Switches (CS) can be assigned to Destinations as described on page 42.

In 1: Source	I/O 6: Unassigned	SFP I/O 12/13: Unassigned
In 2: Source	I/O 7: Unassigned	SFP I/O 14/15: Unassigned
I/O 3: Unassigned	I/O 8: Unassigned	TSG 1: Source
Out 4: Destination	I/O 9: Unassigned	TSG 2: Source
Out 5: Destination	I/O 10: Unassigned	CS 1: Unassigned (430 only)
	I/O 11: Unassigned	CS 2: Unassigned (430 only)

Applications

The flexibility of the BrightEye NXT Compact Router system makes it possible to tailor the inputs and outputs to suit a diverse range of requirements. The BrightEye NXT Compact Routers can accommodate many environments and applications, including the following:

- Mobile and portable systems
- QC stations
- Graphics and post-production islands
- ENG trucks
- Edit suites
- Ingest
- Production switcher pre-select
- Driving on-set monitors
- General utility switching

Cuts-Only Master Control

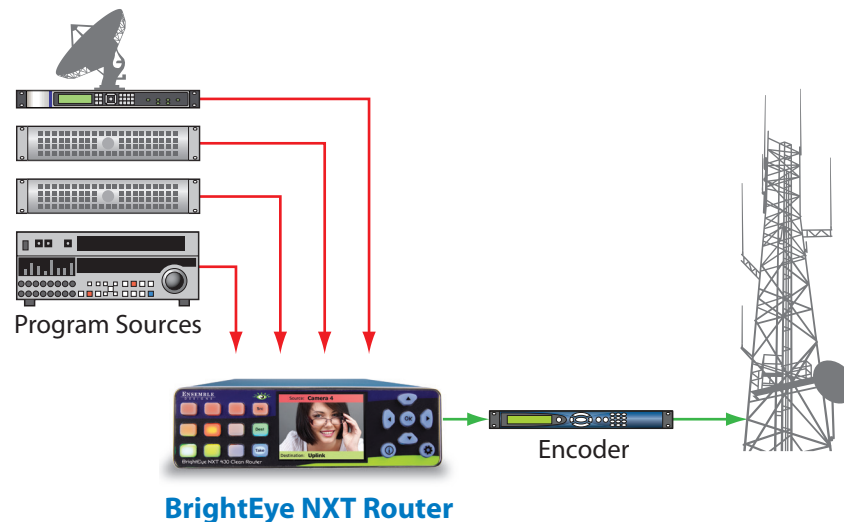

Use the BrightEye NXT Router as a cuts-only master control, on the ground or in the air. Great for helicopters, sports and ENG, the BrightEye NXT Router has built-in frame syncs that let you use sources that don't have a reference. The router's output is clean and quiet, switching seamlessly between sources. Downstream devices such as routers and encoders receive a consistent video input signal.

Quality Control and Signal Monitoring

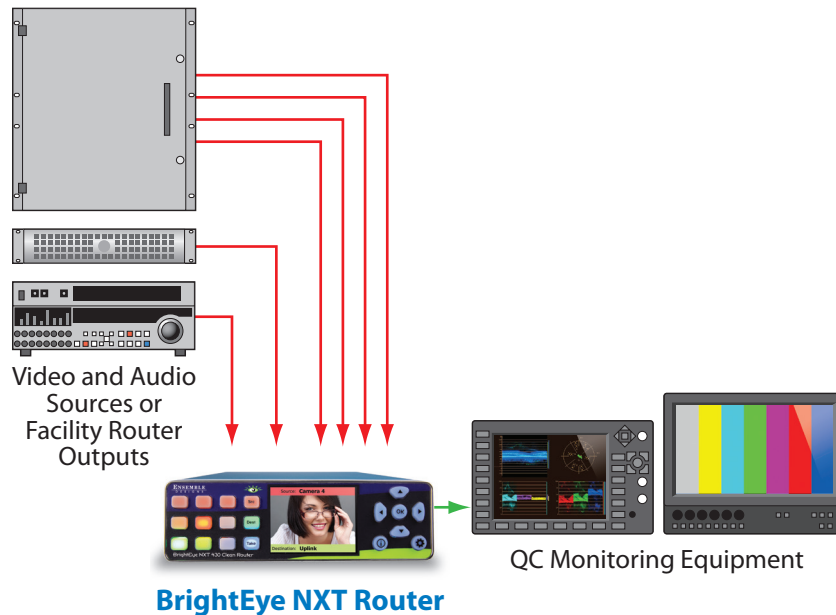

QC your ingest sources or set top box feeds with the BrightEye NXT Router. Verify signal presence right on the front panel of the router. The BrightEye NXT's LCD displays full motion, realtime video of your sources. Take the router outputs to scopes and servers. Use the router's built-in web browser and QC your sources remotely.

Multi-Stage Venue

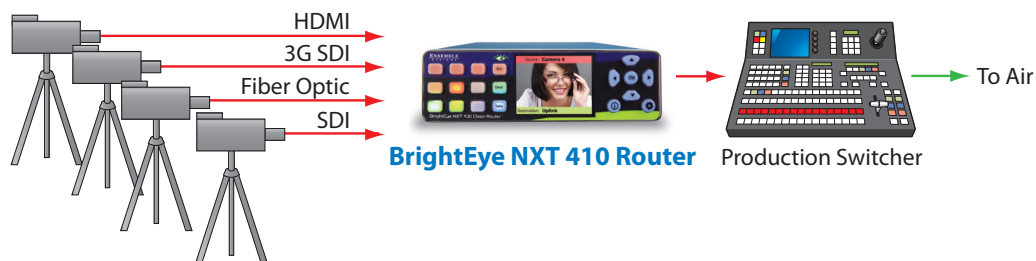

Add more inputs to your production switcher or master control switcher. Feed cameras and other SDI and HDMI sources to a BrightEye NXT 410 Router and take one or more of the router outputs into the production switcher or master control switcher. This is also a great way to integrate HDMI signals into an SDI workflow.

Monitors and Projectors for Venues

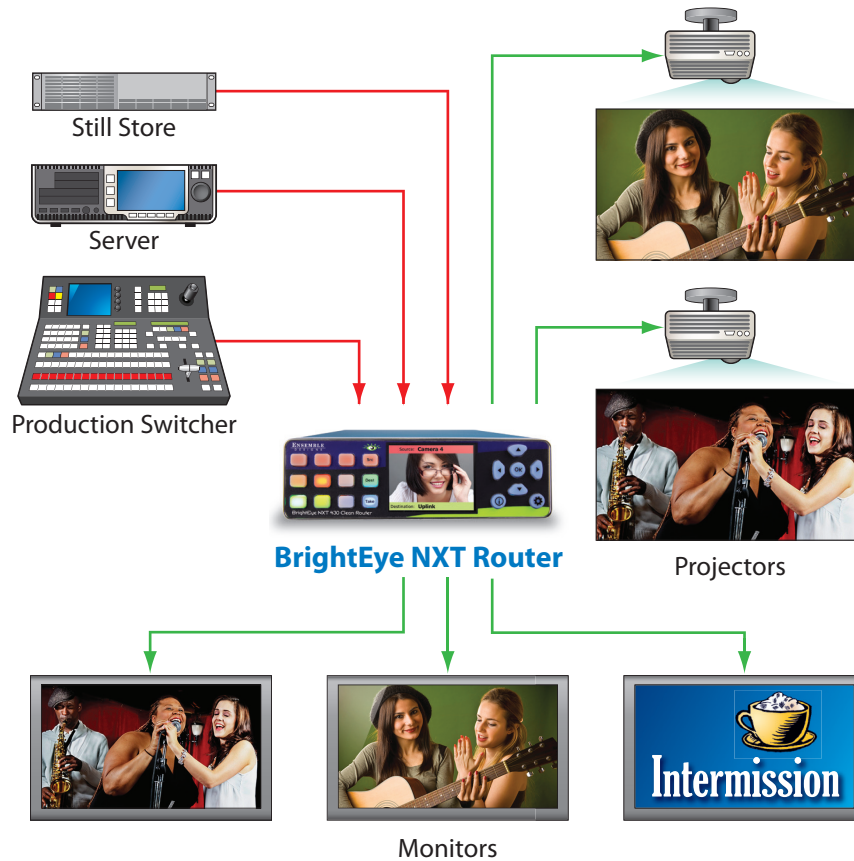

Use the BrightEye NXT Router for live events and sports to route signals to monitors, switchers and projectors. The router's outputs can be easily configured to be in time with house, even when there are asynchronous sources on the input. Switch seamlessly between fiber optic, HDMI and SDI signals.

Chapter 3: Installation

In this Chapter

This chapter describes cable connections for the installation process. Topics addressed include:

- [Connecting Cables to Ports](#)
- [Connecting a Reference If Needed](#)
- [Connecting the Power Supply](#)
- [Connecting Ethernet for Web Control Point \(Optional\)](#)

Connecting Cables to Ports

Make your connections to sources and destinations with 75 ohm coaxial cable. The BrightEye NXT 410 accepts HDMI connectors.

Connecting a Reference If Needed

The BrightEye NXT locks to house reference or to its own internal precision standard. Connect your reference source to the Ref In SDI port on the rear panel. The BrightEye NXT detects and reports ... If no reference is connected, the router locks to its own internal precision standard.

The reference input of the BrightEye NXT will accept these reference types:

- NTSC or PAL analog video
- Tri-Level Sync
- 10 MHz precision reference

When VITC (Vertical Interval Timecode) is present on NTSC or PAL analog composite reference sources, it will be available to the Router for event scheduling.

See [Setting Up Timing and Genlock on page 48](#) for more details about configuring the Router's Timing and Genlock systems.

Connecting the Power Supply

Each BrightEye NXT unit ships with the following power supply:

- Ensemble Designs Part Number 23600106
- Order Information: BEPS-NXT
- Input: 100-240V, 47-63Hz, 1.5A
- Output: 12V, 5.0A

Note: BrightEye NXTs must be powered by their own product-specific power supply that comes with each unit. DO NOT use a BrightEye Spider power supply (BEPS6) or a BrightEye Individual power supply (BEPS, ED part number 23118900) to power BrightEye NXTs.

The boot up process takes about 40 seconds. When first applying power to the BrightEye NXT unit, the **Configuration** button illuminates green for the first ten to fifteen seconds.

Connecting Ethernet for Web Control Point (Optional)

Because you can control and configure the NXT immediately upon boot-up with its built-in front control panel, it is not required to use the Ethernet connection. However, if you want to configure one or more web control points, you will need to network to the Ethernet port.

Use CAT5 or CAT6 cabling to connect the Ethernet port to a network Ethernet router or switch to make it accessible to computers on your network. The Ethernet port will auto-sense cable direction, so a cross-over cable is not needed.

RS-232 Interface Option

As an option, the BrightEye NXT routers can be equipped with cable that has a 9-pin RS-232 port installed at the factory.

Chapter 4: Configuration

In this Chapter

This chapter covers the following topics:

- [Router Configuration Menus](#)
- [Assigning Shortcut Buttons](#)
- [Port Configuration](#)
- [About Clean Switches and Clean Switch Configuration](#)
- [Configuring Clean Switches from the Front Panel](#)
- [Configuring Clean Switches from the Web Interface](#)
- [Setting Up Timing and Genlock](#)
- [Working with the Internal Test Signal Generators](#)
- [Setting Up a Web Control Point \(Optional\)](#)
- [Establishing Additional Web Control Points and Access Authentication](#)
- [Creating and Editing Profiles](#)
- [Security and Administrative Access to Settings](#)

Router Configuration Menus

Two sets of configuration menus are available—one through the front panel, the other through the web interface. An overview of these respective sets of menus are given on this page and on page 29.

Menus Accessed from the Front Panel	
Panel Config	Shortcuts, Transition Duration, Direct Take or Preset/Take, Panel Brightness, Audio Meters, Meter Reference Level, Peak Display, Live Video On or Muted
Ports	Define ports according to port type, edit port names, adjust audio levels and audio mapping
TSG1	Select a test signal, choose its standard, adjust test signal output timing
TSG2	Same as test signal generator 1, but for the 2nd TSG
Clean Switch 1	Set the clean switch's standard and assign it to an output, choose audio breakaway settings. 410 and 430 units only.
Clean Switch 2	Same as Clean Switch 1, but for the 2nd Clean Switch
Timing & Genlock	Select between external and internal reference, get info about the system frame rate (determined by TSG1)
Network	Change the router's IP address and other network settings



Configuration Controls

All of the configuration buttons are located to the right of the front panel screen.



Front Panel Navigation

Press to bring up the configuration menus on the front panel screen.

Use the arrows to scroll through the configuration menus, navigate submenus, or to change the values of a selected setting.

Press or to drop down successive levels within a menu.

Press or to come back up one menu level.

Configuration Button

Press the Configuration button to access the configuration menus. Once in the configuration menus, pressing the Configuration button backs out one level. When in configuration mode, hitting a button in operations gets you out of configuration mode and immediately into operations mode. Pressing the Configuration button again brings you right back to the last Configuration menu you visited.

Pressing any operational button—any button to the left of the screen—will take you immediately from configuration mode to the router's operational mode.

After approximately 30 seconds of inactivity of the configuration controls, the BrightEye NXT screen will time out and revert to the router's operational mode.

Navigation Buttons

Use the Up, Down, Left and Right arrow buttons to navigate the menu system and adjust settings.

Information Button

Press the Info button to access info screens about the NXT unit, such as software version, network information, rear connectors, SFP port information, and system bootup status.

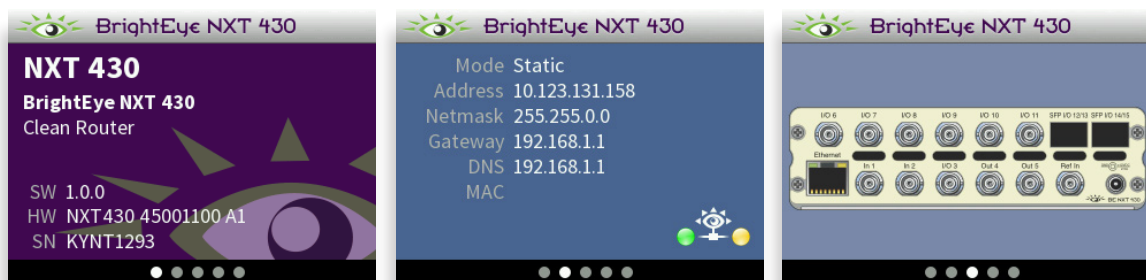

Menus Accessed from the Web Interface	
General	Modify the name of the unit. Access reporting information about model, software version and serial number. Enable password requirement or change the password.
Network	Change the router's IP address and other network settings
Timing & Genlock	Select between external and internal reference, get info about the system frame rate (determined by TSG1)
Ports	Name Sources and Destinations, define ports as inputs or outputs as needed
Test Signals	Select test signals, choose standards, adjust test signal output timing
Clean Switches	Set the standards for both clean switches. Assign them to outputs, choose audio breakaway settings. 410 and 430 units only.
Salvos	Configure Salvos, enabling you to route a selected set of sources to a selected set of destinations simultaneously.
Profiles	Create, edit and delete profiles
Control Points	Enable control points, assign profiles to control points
External Control	Enable TCP/IP control, select a protocol, assign a profile

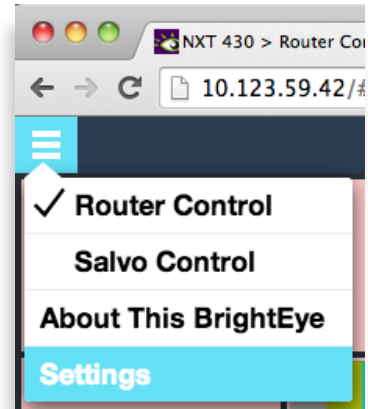

Accessing the web interface configuration menus

Assigning Shortcut Buttons

Assign Sources and Destinations to the nine shortcut buttons on the front panel in order to streamline router operation. You can have any combination of Source, Destination and Unassigned shortcut buttons.

This task can be done only from the BrightEye NXT front panel.

To assign the shortcut buttons:

1. Press the Configuration button. The top level menus display. The top menu listed is Panel Config.
2. Press the right arrow button (or **OK**) to highlight the Shortcuts submenu.
3. Press the right arrow button (or **OK**) to go to the Panel Config shortcut button map.
4. Initially, the top left button is selected. Use the left and right arrow buttons to select the button you want to configure.
5. Use the up and down arrow buttons to change which input, test signal generator or output to which it is assigned. Or you can map it to "Unassigned."
6. Press **OK** to save your new selection to the highlighted shortcut button.
7. Press the Configuration button to back out of the menu one level at a time. Or wait approximately 30 seconds until the screen automatically returns to Operational mode.

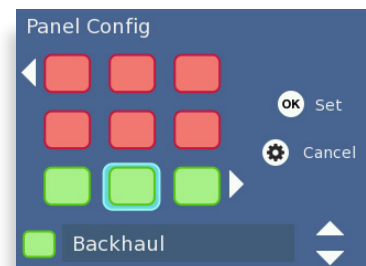
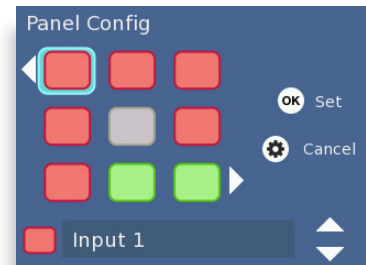

About Port Configuration

Planning Router Port Configuration

Typically, during the planning stage of your Router implementation, you would determine in advance how you want to initially use the Router in terms of inputs, outputs and test signals.

Cabling Router and Configuring Ports to Match Plan

Based on your plan, connect cables to the ports to match your intended use, and configure the ports to match how you have wired the router for your facility.

Before going step-by-step through the process of configuring the Router's ports, it is necessary to go over some background information in order to understand what the configuration options mean.

Definitions of Port Configuration Choices

Port configuration choices are described below, followed by detailed examples.

Unassigned

For all Port Types

A port can be set to Unassigned when it is not in use. This will remove it from the list of Sources and Destinations that can be assigned to a Control Profile.

Source

For Fixed Input and Bi-directional Ports

When configured as a Source, a port is an input to the switching matrix. The Source can be given a name, and under that name it will be available for assignment in a Control Profile. Making this selection on bi-directional ports will cause them to operate as inputs.

Destination

For Fixed Output and Bi-directional Ports

Configuring a port as a Destination makes it available for use in Control Profiles under its assigned name as a Router output. A bi-directional port configured as a Destination will cause it to operate as an output.

Follow

For Fixed Output and Bi-directional Ports

Output capable ports can be configured to Follow, or duplicate, the signal on any Source or Destination. The Follow configuration essentially makes a port into a DA. Ports that are configured to Follow will not appear on the list of Sources and Destinations that can be assigned to a Control Profile.

Primary TSG

For Fixed Output and Bi-directional Ports

This Primary TSG configuration delivers the test signal being generated in the Primary TSG to an output port, independently of any user control of the switching matrix.

Secondary TSG

For Fixed Output and Bi-directional Ports

The Secondary TSG configuration delivers the test signal being generated in the Secondary TSG to an output port, independently of any user control of the switching matrix.

Port Configuration Choices Available According to Port Type

These three port types (fixed input, fixed output, bi-directional) can be configured in the following ways:

For Fixed Input

Fixed Input ports can be configured in one of two ways:

1. Unassigned
2. Source (the default on a new installation)

For Fixed Output

Fixed Output ports can be configured in one of five ways:

1. Unassigned
2. Destination (the default on a new installation)
3. Follow
4. Primary TSG
5. Secondary TSG

For Bi-Directional

Bi-directional ports can be configured in one of six ways:

1. Unassigned (default on new installation)
2. Source
3. Destination
4. Follow
5. Primary TSG
6. Secondary TSG

Configuring the Router's Ports from the Front Panel

Now that we have covered the background context for numbers and types of Router ports available and what the various configuration selections mean, you are ready to configure the Router's ports.

This section covers assigning ports, renaming ports, adjusting audio levels, and mapping audio channels.

Port configuration can be done from either the BrightEye NXT front panel or from the web interface (once a web control point has been established).

Assigning Ports

Assign each port that you need to use. Once you have assigned a port, it becomes available to include in a Profile. It's fine to leave ports unassigned if you don't need to use them.

To Assign Ports

1. Press the Configuration button. The top level menus display.
2. Press the down arrow button to select the top level Ports menu.
3. Press the right arrow button (or OK) to highlight the top Ports submenu.
4. Press the up or down arrow buttons to select the Port you want to assign.
5. Press the right arrow button (or OK) to go to the Ports Configuration submenu for your selected Port.
6. Use the up and down arrow buttons to change the Port's assignment. The choices available reflect the type of Port you are working with, whether it is I/O, a dedicated source or a dedicated destination Port. Dedicated ports can be either what they are, or they can be disabled by selecting "Unassigned."
7. Press OK to set your new Port configuration selection, or press the Configuration button to cancel your selection.
8. Press the Configuration button to back out of the menu one level at a time. Or wait approximately 30 seconds until the screen automatically returns to Operational mode.

Repeat steps 1 through 8 for as many Ports as you need to assign for your facility.

Renaming Ports

Giving ports descriptive names makes them easier to work with. Port names display in a number of places: on the front panel LCD screen

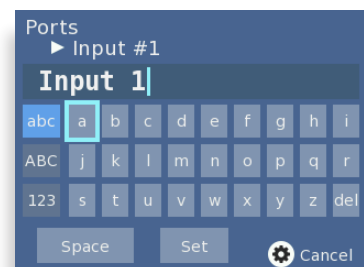
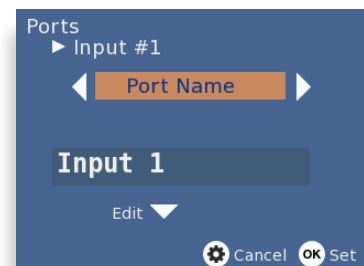
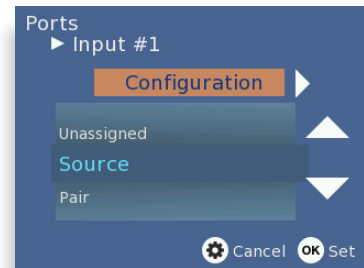
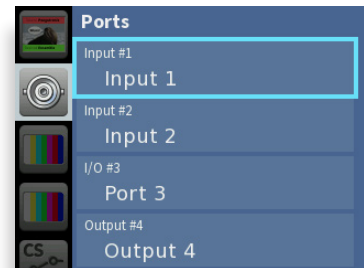

header and footer, on the front panel Port menus, on the video thumbnails used in the web interface, on Profiles, and on the Ports configuration page of the web interface.

To Rename a Port

1. From the Ports Configuration submenu, press the right arrow button to go to the Port Name submenu.
2. Press the down arrow button to go to the keyboard submenu.
3. Use the up, down, left and right arrow buttons to navigate the keyboard. Press OK to enter a keyboard character into the label area. Change case by highlighting and selecting either “abc” or “ABC.” To backspace or delete letters one at a time, highlight the “del” key, then press OK.
4. When finished editing the port name, highlight “Set” on the keyboard and press OK.

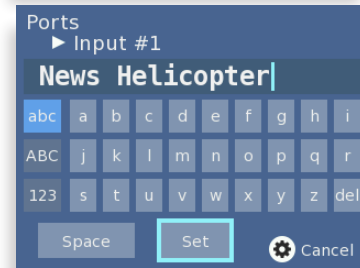
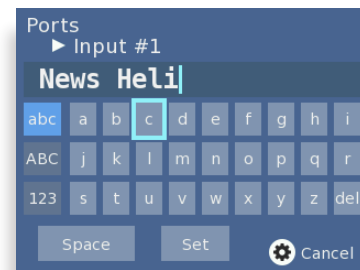

Adjusting Audio Levels

When the signal is output through a Clean Switch, you can adjust audio levels on a per-input and per-channel basis. The BrightEye NXT compact routers can apply gain or attenuation from +12.0 dB to -70 dB.

When the Clean Switch is in Mix mode, the audio output will properly mix between the adjusted settings of one input to the adjusted settings of the new source.

To Adjust Audio Levels

1. From the **Port Name** menu, press the right arrow button to enter the **Audio Gain** menu.
2. Press the down arrow button to go to the **Audio Gain** editing screen.
3. Use the right and left arrow buttons to select the channel you want to modify. The selected channel is indicated by a blue field surrounding the channel's level control. In the example to the right, channel 16 is selected.
4. Press the up or down arrows to adjust the audio levels to be higher or lower. Press and hold the up or down arrow button to accelerate the rate of adjustment.

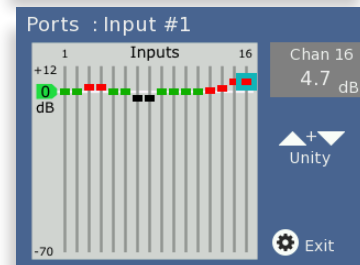
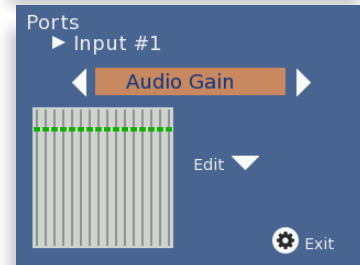

A red marker indicates that gain has been added. A black marker indicates that gain has been reduced. A green marker indicates that the audio level is at its default setting.

5. When finished adjusting the audio levels, press the configuration button to exit and return to the **Audio Gain** menu.

Mapping Audio Channels

For any given video Input source, which can carry up to 16 audio channels, any audio Input channel can be assigned to any audio Output channel.

Each point on the audio map represents a potential cross-point for a specific audio channel Input and Output. By default, Input 1 is mapped to Output 1, Input 2 is mapped to Output 2, and so forth. This default configuration is shown in the middle screen capture to the right.

As a remapping example using Port Input #1, suppose you needed to switch channels 1 and 2 with channels 3 and 4 on the outputs. Using the Audio Map menu, you can assign inputs 1 and 2 to outputs 3 and 4, and assign inputs 3 and 4 to outputs 1 and 2. This configuration is shown in the lower screen capture to the right.

To Remap Audio Channels

1. From the **Audio Gain** menu, press the right arrow button to access the **Audio Map** menu.
2. Press the down arrow button to go to the **Audio Map** editing screen.
3. To edit the audio map, use the arrows to select a point on the grid.
4. Press the OK button to activate the selected cross-point. Pressing the OK button toggles between purple (active cross-point) and gray (not active cross-point).
5. When finished, press the configuration button to exit.

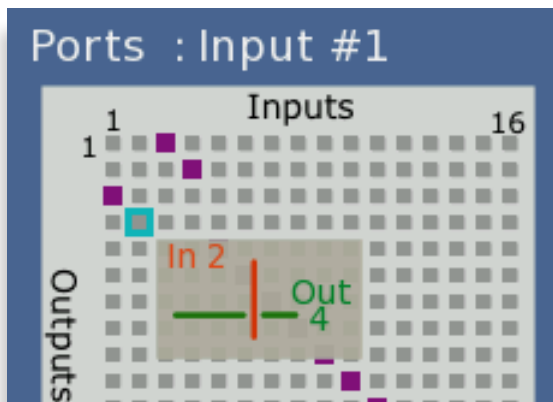
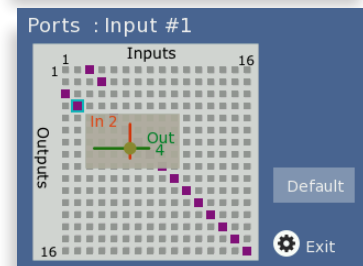
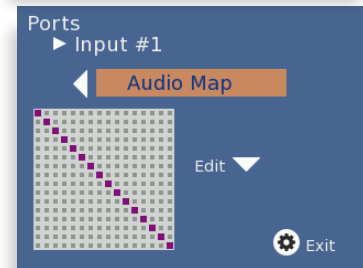
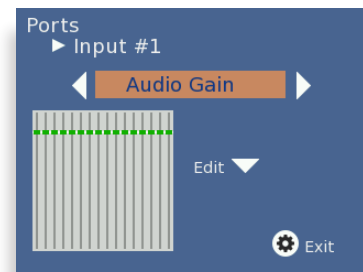

Inactive cross-point.

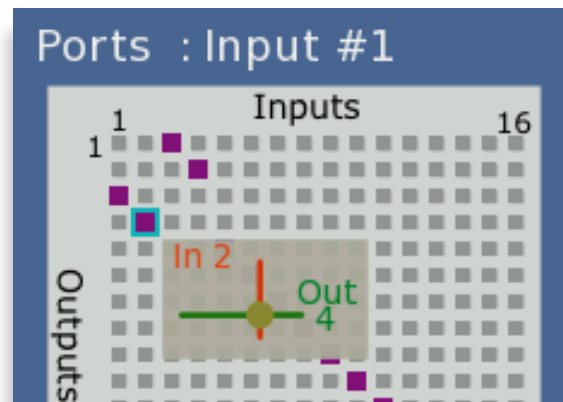

Active cross-point.

Configuring the Router's Ports from the Web Interface

From the upper-left drop-down menu of the web interface, select Settings. The Settings > General page displays.

Note: If you have not previously established a web control point, please see: [Setting Up a Web Control Point \(Optional\)](#) on page 62.

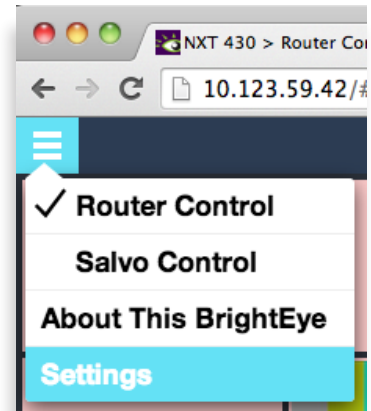

Assigning and Naming Ports

Assign each port that you need to use. Once you have assigned a port, it becomes available to include in a Profile. It's fine to leave ports unassigned if you don't need to use them.

Giving ports descriptive names makes them easier to work with. Port names display in a number of places: on the front panel LCD screen header and footer, on the front panel Port menus, on the video thumbnails used in the web interface, on Profiles, and on the Ports configuration page of the web interface.

To Assign and Name Ports

From the left navigation panel of the Settings > General page, select **Ports**. The Ports page displays. Initially, all the non-dedicated ports show "Unassigned" for the Type drop-down control.

For each port that you plan to use, take the following steps:

1. Select its Type from the Type drop-down control.
2. Enter a port name in the Name field.

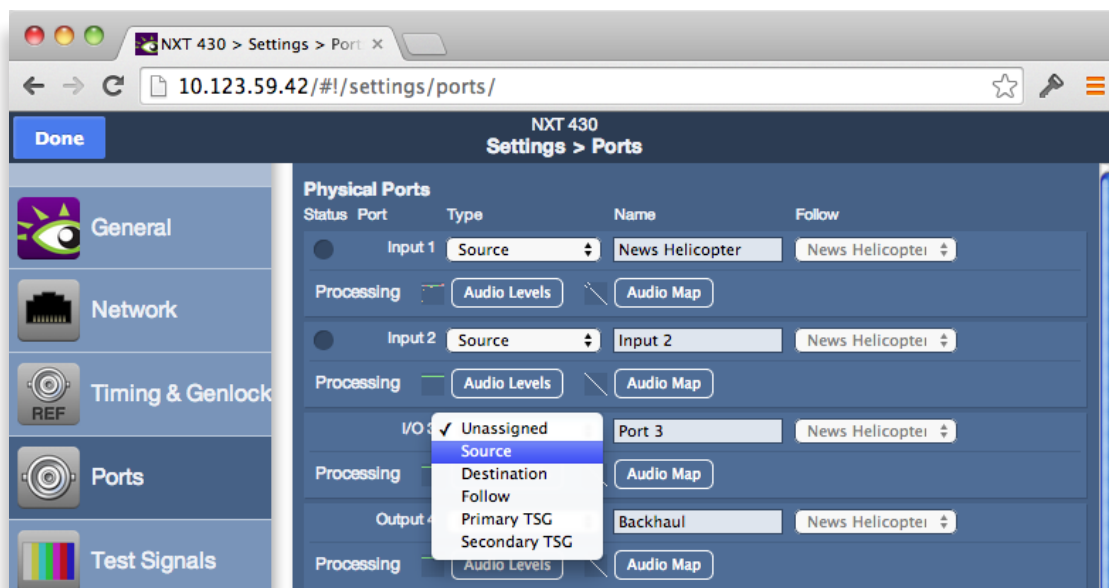

Configuring Ports: Making a selection from the Type drop-down control for I/O Port 3

3. If applicable, make a selection from the Follow drop-down control.
4. Click **Done** near the upper left area of the browser window to save your changes.

Adjusting Audio Levels

When the signal is output through a Clean Switch, you can adjust audio levels on a per-input and per-channel basis. The BrightEye NXT compact routers can apply gain or attenuation from +12.0 dB to -70 dB.

When the Clean Switch is in Mix mode, the audio output will properly mix between the adjusted settings of one input to the adjusted settings of the new source.

To Adjust Audio Levels

1. From the **Ports** page of the web interface, select the Audio Levels button for the Port you want to work with. The Audio Level Gain menu displays.

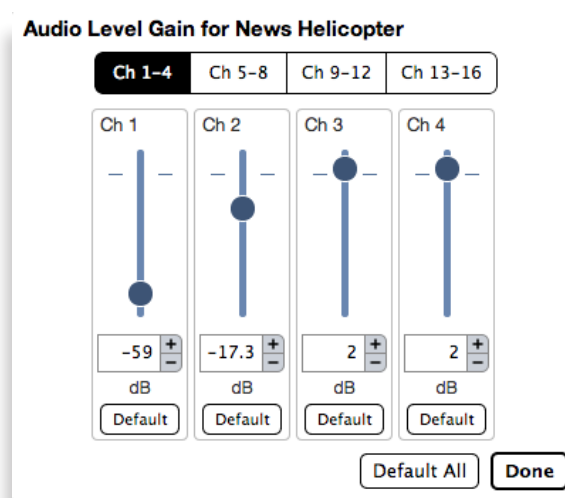

The Audio Level Gain menu for channels 1 - 4 of Port 1, renamed News Helicopter

2. Click and drag the slider control up or down to adjust the audio levels to be higher or lower for each channel. Or you can enter a number directly into the field directly beneath the slider control, or click the + or - symbols to adjust the number incrementally. Click Default to return to the default value of 0 dB for a specific channel. Click Default All to return the default value to all of the channels.
3. Select a different button along the top (Ch 5-8, Ch 9-12, Ch 13-16) to access the controls for those audio channels.
4. When finished adjusting the audio levels, click Done. The Audio Level Gain menu closes, and you will return to the main Ports page.

Mapping Audio Channels

For any given video Input source, which can carry up to 16 audio channels, any audio Input channel can be assigned to any audio Output channel.

Columns represent Input Channels, while rows represent Output Channels. Each point on the audio map shown below represents a potential cross-point for a specific audio channel Input and Output. By default, Input 1 is mapped to Output 1, Input 2 is mapped to Output 2, and so forth. This default configuration is shown in the example on the left.

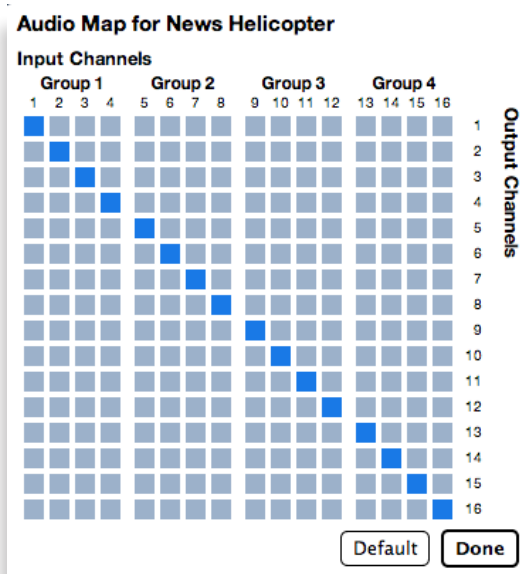

Audio Map default configuration

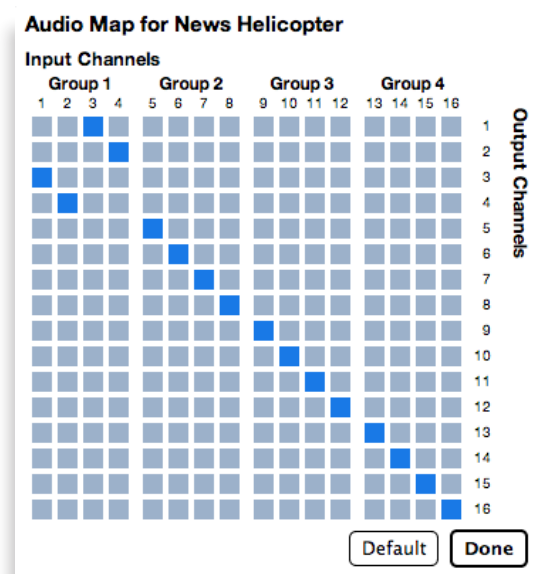

Audio Map configured so that inputs 1 and 2 go to outputs 3 and 4; and inputs 3 and 4 go to outputs 1 and 2.

As a remapping example using Port Input #1, suppose you needed to switch channels 1 and 2 with channels 3 and 4 on the outputs. Using the Audio Map menu, you can assign inputs 1 and 2 to outputs 3 and 4, and assign inputs 3 and 4 to outputs 1 and 2. This configuration is shown in the above screen capture on the right.

To Remap Audio Channels

1. From the **Ports** page of the web interface, select the Audio Map button for the Port you want to work with. The Audio Map control displays.

Selecting a point on the grid toggles that point on or off. The grid points that are dark blue are active; the gray grid points are inactive.

2. Columns represent Input Channels. Rows represent Output Channels. Referencing the example shown above, click the grid point at column 1, row 1 to make it inactive (gray). Then click the grid point at column 1, row 3 to make it active (dark blue). The result is that Input Channel 1 is now going out through Output Channel 3 instead of Output Channel 1.
3. When finished adjusting the audio map, click Done. The Audio Map control closes, and you will return to the main Ports page.

About Clean Switches and Clean Switch Configuration

The two built-in clean switches for the BrightEye NXT 410 and BrightEye NXT 430 are useful when switching between asynchronous sources or for taking a router output directly to air. When a Clean Switch is assigned to an output port, its input is fed from the routing matrix and it drives the output connector. Any source in the Router switched to this output will be presented synchronously and timed.

Configuration of the Clean Switch includes its video format, timing, and embedded audio group enables.

Genlocked to Reference

The Clean Switch is genlocked to the reference being used within the Router. This ensures that the output is stable regardless of the input signal. Not only does this ensure clean switching between un-timed and even asynchronous sources, it also guarantees a stable, Black output upon loss of input.

Embedded Audio

In parallel with the video processing, 16 channels of embedded audio are silently switched as well. Incoming audio is disembedded, sample rate converted, switched, and then embedded into the output. The audio processing includes a delay mechanism to compensate for the delay imposed on the video by the frame sync. This compensation ensures that the time relationship (lip-sync) between audio and video is maintained.

Output Port Following a Clean Switched Destination

If an output port has been configured to Follow a Destination which has a Clean Switch assignment, that port will also deliver the Clean Switch output. That port set to Follow will not be seen as a destination on a control panel because there is still only one Destination. The conceptual effect of this is to have incorporated an output DA (Distribution Amp) into the Router.

Clean Switch Output Timing

Using the Output Timing control, you can adjust the timing of the Clean Switch relative to the genlock reference. The best or most appropriate setting for the timing controls will depend upon the way in which the Clean Switch is to be used and the nature of the video inputs.

Setting the H and V parameters to 0 will “zero” time the Clean Switch, matching it to the reference. Negative values will cause the Clean Switch to be early with respect to the reference; positive values will make the Clean Switch output later in time.

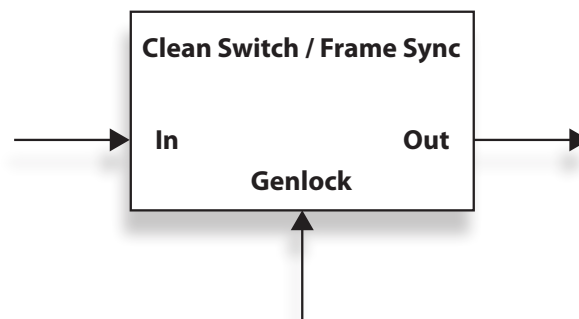

Imposing Delay on a Video Signal

A video frame sync imposes delay on a video signal passing through it in order to align that input to the user adjusted output timing. The amount of delay is a function of the difference in timing between the incoming video and the output of the frame sync. The frame sync can only add delay to the video in order to make up that difference, and the amount will change automatically in accordance with the timing of the input signal.

If the input signal is one line early compared to the output, the frame sync will add only one line of delay. But if the incoming video is just one line late, the frame sync will add nearly an entire frame (less one line) to bring the signal into time. If the input is asynchronous, its timing will be changing (drifting) continuously. In that case, the delay imposed by the frame sync will vary continuously between (near) zero and one frame.

Pre-Selector to a Production Switcher

When a Clean Switch is being used as a pre-selector to a production switcher, the Clean Switch output timing must fall within the input auto-time window of the switcher. In general, this will be accomplished by setting the Clean Switch H and V parameters to zero.

Feeding On-Set Monitors in a Live Environment

If the Clean Switch is feeding on-set monitors in a live environment from sources also used on the production switcher, it is generally desirable to minimize the delay on those monitors. This is accomplished by setting the Vertical timing of the Clean Switch to a small positive value. Setting this parameter to +4 lines will typically guarantee that the sources (which have near zero timing) will only experience 2 or 3 lines of delay. Since most production switchers have a forward delay of 1, 2, or 3 lines, a setting of +4 lines on the Clean Switch will also allow the switcher output to be used with minimum delay.

Configuring Clean Switches from the Front Panel

For the routers to switch cleanly between sources, both sources need to be in the same standard and the Clean Switch needs to be configured to that standard, too. For example, if you are using 1080i/50 signals, set the Clean Switch to 1080i/50. Note that if you feed a signal to the Clean Switch that is set to a different standard (for example, if a 525 SD signal is fed to a Clean Switch that is set to 1080i/50), the Clean Switch will output black and silence.

To Assign a Clean Switch to a Destination

1. Press the Configuration button. The top level menu display.
2. Use the up or down arrow buttons to select the top level menu for either Clean Switch 1 or Clean Switch 2.
3. Press the right arrow button (or OK) to highlight the Assignment submenu.
4. Press the right arrow button (or OK) to go to the Assignment selection submenu.
5. Press the up or down arrow buttons to select the destination Port to which you want to assign the selected Clean Switch.
6. Press OK to set your new Clean Switch assignment, or press the Configuration button to cancel your selection.
7. Press the Configuration button to back out of the menu one level at a time. Or wait approximately 30 seconds until the screen automatically returns to Operational mode.

To Set the Standard for Clean Switches

1. From the Clean Switch top level menu, use the up or down arrow buttons to navigate to the Standard menu.
2. Press the right arrow button (or OK) to go to the Clean Switch Standard submenu.
3. Use the up or down arrow buttons to select the standard you want the Clean Switch to use.
4. Press OK to set the standard to your new selection, or press the Configuration button to cancel your selection.
5. Press the Configuration button to back out of the menu one level at a time. Or wait approximately 30 seconds until the screen automatically returns to Operational mode.

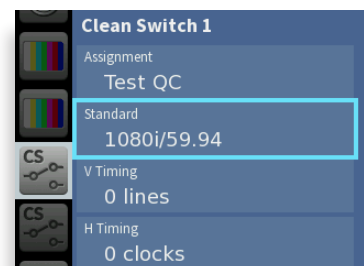
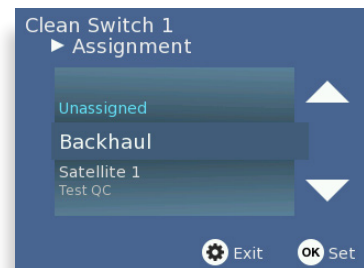
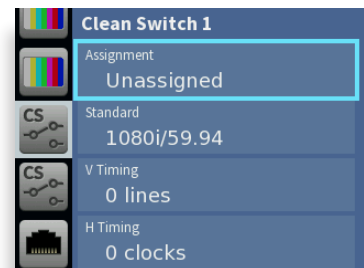

To Set the Output Timing for Clean Switches

Using the Output Timing control, you can adjust the timing of the Clean Switch relative to the genlock reference. Setting the H and V parameters to 0 will “zero” time the Clean Switch, matching it to the reference. Negative values will cause the Clean Switch to be early with respect to the reference; positive values will make the Clean Switch output later in time.

1. From the Clean Switch top level menu, use the up or down arrow buttons to navigate to the V Timing or H Timing menu.
2. Press the right arrow button (or OK) to go to the Clean Switch V Timing or H Timing submenu.
3. Use the up or down arrow buttons to indicate the timing setting you want the Clean Switch to use.
4. Press OK to set the timing to your new selection, or press the Configuration button to cancel your selection.
5. Press the Configuration button to back out of the menu one level at a time. Or wait approximately 30 seconds until the screen automatically returns to Operational mode.

To Set the Audio Enables for Clean Switches

The Clean Switch supports 16 channels (four groups) of embedded audio. In order for the Clean Switch output to have a consistent configuration of audio, regardless of what is present on the input, individual enables are provided for each group.

The Clean Switch output will always contain the enabled groups, but channels that are not present in the input will simply be silent. In this way, switching between sources with differing audio configurations will produce smooth, silent transitions.

If you are using embedded audio, enable the appropriate audio groups.

1. From the Clean Switch top level menu, use the up or down arrow buttons to navigate to the Audio Enables menu.
2. Press the right arrow button (or OK) to go to the Audio Enables submenu.
3. Use the right or left arrow buttons to navigate to the submenu you want to work with: Group 1, Group 2, Group 3 or Group 4.
4. Use the up or down arrow buttons to select On or Off.
5. Press OK to set your new selection, or press the Configuration button to cancel your selection.
6. Press the Configuration button to back out of the menu one level at a time. Or wait approximately 30 seconds until the screen automatically returns to Operational mode.

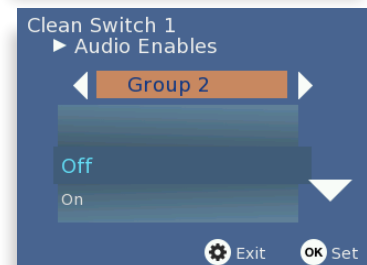
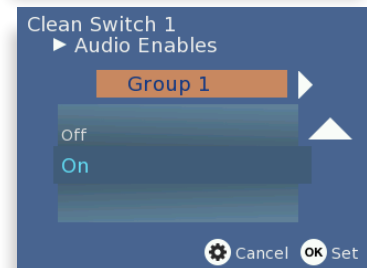
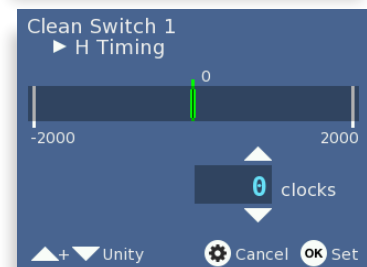
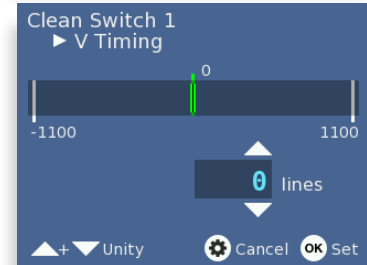

To Set Audio Breakaway

Audio Breakaway is accessed through the following Clean Switch menus:

1. From the Clean Switch top level menu, use the up or down arrow buttons to navigate to the Audio Source menu.
2. Press the right arrow button (or OK) to go to the Audio Source submenu.
3. Use the up or down arrow buttons to select the audio source you want to designate for the Clean Switch.
4. Press OK to set your new selection, or press the Configuration button to cancel your selection.
5. Press the Configuration button to back out of the menu one level at a time. Or wait approximately 30 seconds until the screen automatically returns to Operational mode.

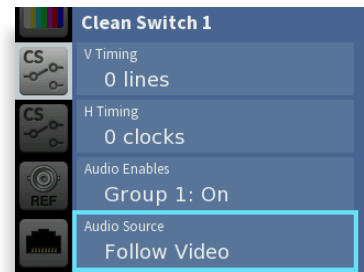

Configuring Clean Switches from the Web Interface

There are two sets of configuration controls, one for each of the two Clean Switches. Clean Switch 1 and Clean Switch 2 are configured independently.

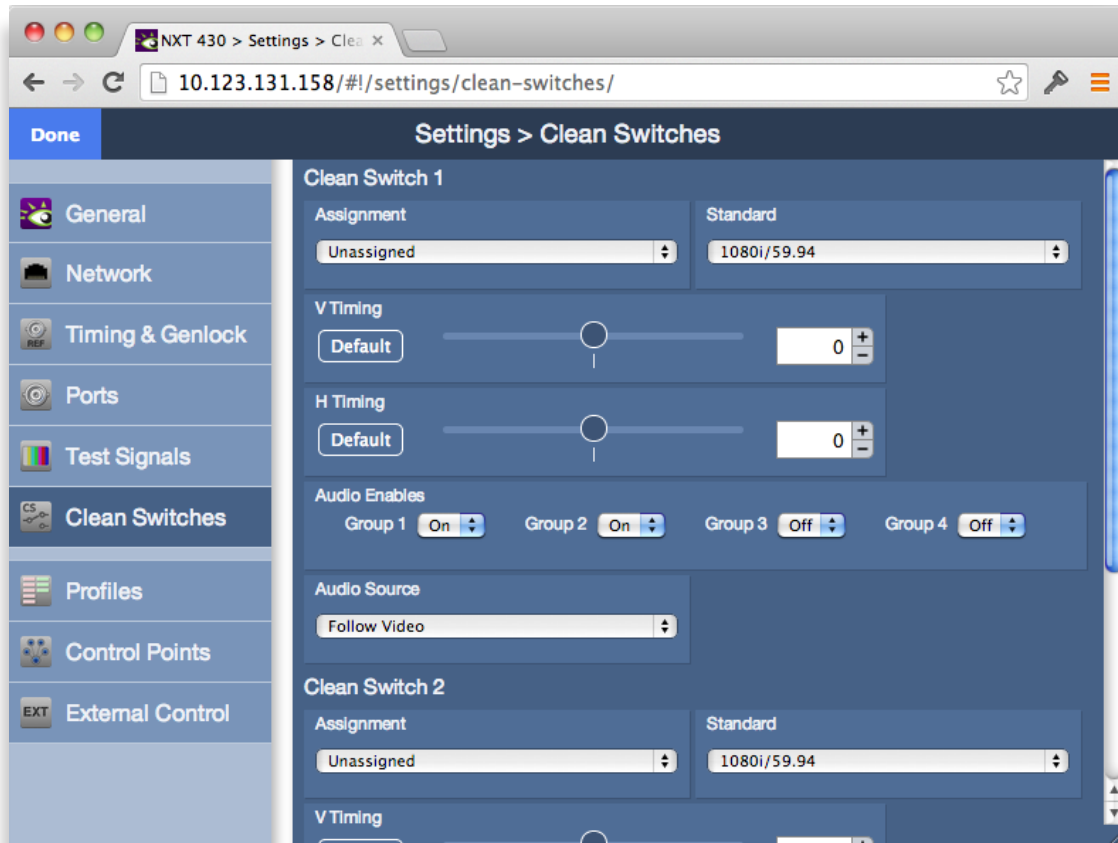

The Clean Switch configuration page from the web interface

The web interface configuration controls for the Clean Switches are as follows:

To Assign a Clean Switch to a Destination

Assign the Clean Switch to any of the Destinations (Output Ports) that have been configured in the Port Configuration menu. Only the currently available Destinations will be presented as choices in this menu. Because only one CS can be assigned to any given Destination, the list presented will not include any ports that are already assigned to other Clean Switches. In order to change assignments to move a port from one CS to another CS, you must first release the original assignment by selecting "Unassigned."

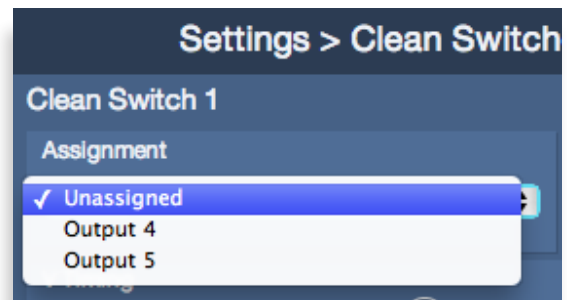

Output 4 and Output 5 are the default Ports available for Clean Switch assignment.

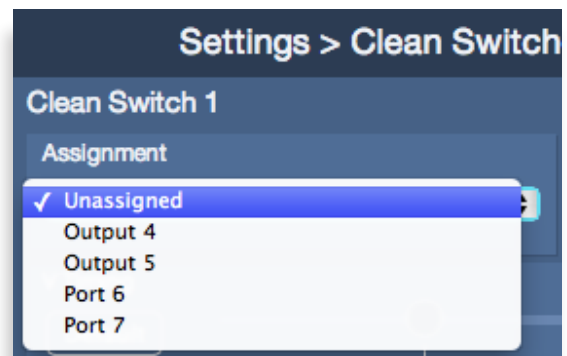

When you assign additional Ports as Destinations, they become available for Clean Switch assignment.

To Set the Standard for Clean Switches

Select the desired operating format and frame rate. Only input signals matching that Standard will be processed by the Clean Switch.

If a source in a different format is selected, the CS will be bypassed and the source will be switched to the output without any processing.

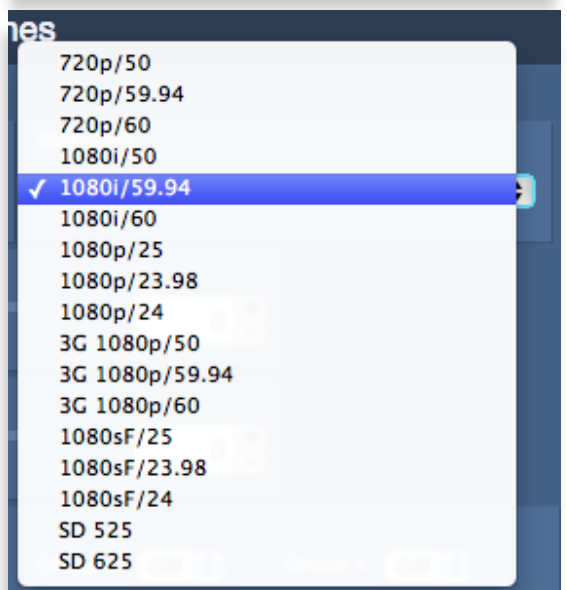

To Set the Output Timing for Clean Switches

Using the Output Timing control, you can adjust the timing of the Clean Switch relative to the genlock reference. Setting the H and V parameters to 0 will “zero” time the Clean Switch, matching it to the reference. Negative values will cause the Clean Switch to be early with respect to the reference; positive values will make the Clean Switch output later in time.

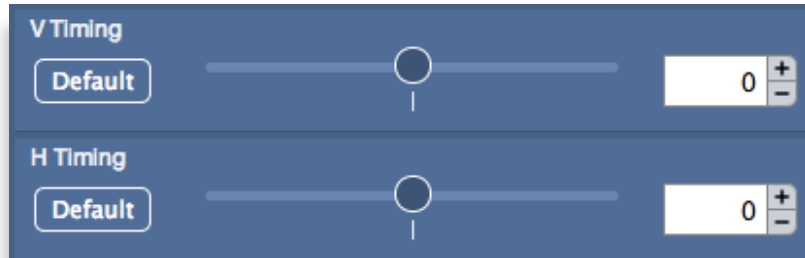

To Set the Audio Enables for Clean Switches

The Clean Switch supports 16 channels (four groups) of embedded audio. In order for the Clean Switch output to have a consistent configuration of audio, regardless of what is present on the input, individual enables are provided for each group.

The Clean Switch output will always contain the enabled groups, but channels that are not present in the input will simply be silent. In this way, switching between sources with differing audio configurations will produce smooth, silent transitions.

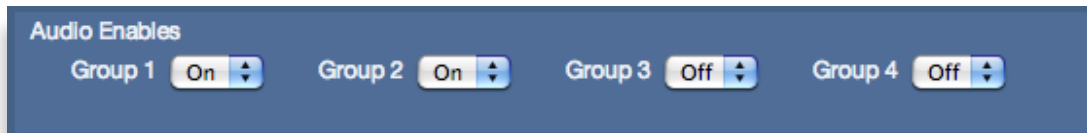

To Set the Audio Breakaway for Clean Switches

If you need to configure the audio source for the Clean Switch you are using:

- From the Clean Switches web interface page, make an audio source selection from the Audio Source drop-down menu.

Setting Up Timing and Genlock

The BrightEye NXT Compact Router can be locked to an external reference or operated from an internal precision reference. The Reference Source control selects between those two choices.

The Reference Status indicator displays the status of the currently selected reference.

To Select the Reference Source from the Front Panel

1. Press the Configuration button. The top level menus display.
2. Use the up or down arrow buttons to select the top level menu for Timing & Genlock.
3. Press the right arrow button (or OK) to highlight the Reference Source submenu.
4. Press the right arrow button (or OK) to go to the Reference Source selection submenu.
5. Press the up or down arrow buttons to select Internal or External.
6. Press OK to set your Reference Source selection, or press the Configuration button to cancel your selection.
7. Press the Configuration button to back out of the menu one level at a time. Or wait approximately 30 seconds until the screen automatically returns to Operational mode.

The BrightEye NXT uses the video format selection of the Primary Test Signal Generator to determine two system-wide parameters—System Frame Rate, and Vertical Interval Switch Point.

System Frame Rate

Distributed within the BrightEye NXT is a System Frame Rate Reference. It is used to vertically lock the outputs of the internal Test Signal Generators and the Clean Switch frame syncs. The System Frame Rate is selected by the Primary Test Signal Generator. If the selected genlock reference is in the same frame rate family (see the [Note on Frame Rates](#) on the next page), the System Frame Rate Reference will also be locked to the external reference. If the external reference is in a conflicting frame rate family (for example, SD 525 reference vs. 1080p/50 in the Primary Test Signal Generator), the System Frame Rate Reference will be internally generated.

Vertical Interval Switch Point

The precise point in the vertical interval where the crosspoint switch will occur is taken from the timing of the Primary Test Signal Generator. This provides flexibility in the system by allowing, for example, the use of an SD reference with a matrix that changes at HD switch points.

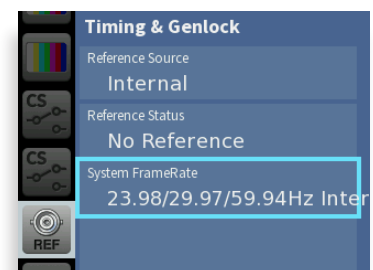
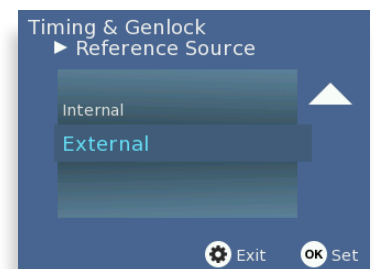
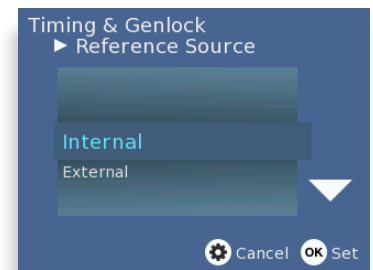
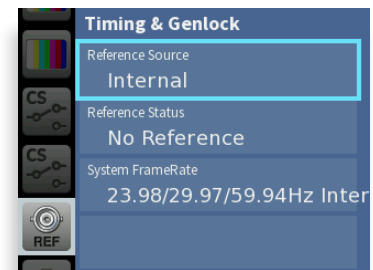
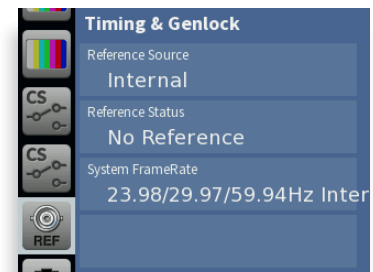

To Select the Reference Source from the Web Interface

1. From the left navigation panel of the web interface, select **Timing & Genlock**. The Timing & Genlock page displays.
2. From the Reference Source drop-down control, select Internal or External.
3. Click **Done** near the upper left area of the browser window to save your changes.

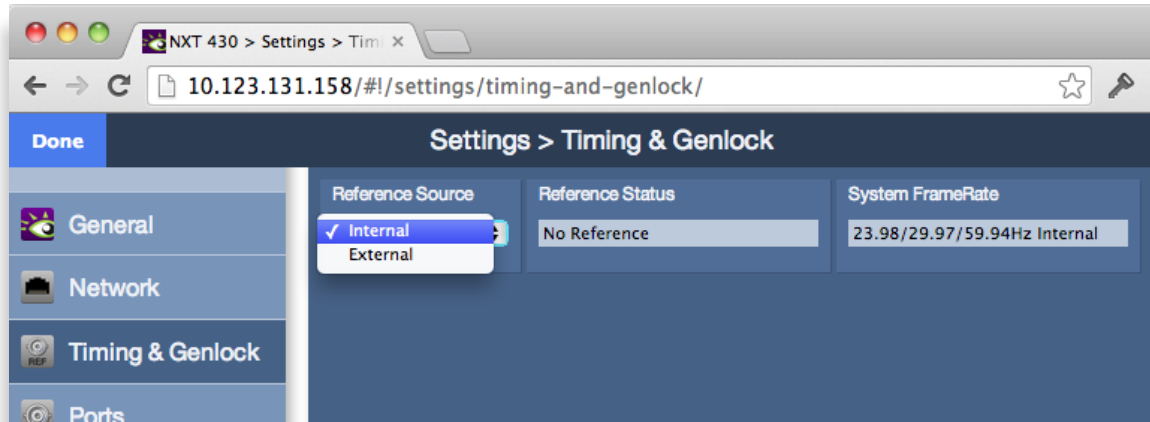

Note on Frame Rates

Despite the large number of video formats supported by the Router, there are only three possible frame rate families.

50 Hz	The 50 Hz frame rate family includes 25 Hz and 50 Hz frame and field rates. This family includes all of the "PAL" related standards in both standard and high definition.
59.94 Hz	All of the NTSC-derived standards, including 23.98, 29.97, and 59.94 Hz field and frame rates. There is a 4 Frame to 5 Frame relationship between 23.98 and 59.94 which allows these to peacefully co-exist.
60 Hz	The "not quite 60 Hz" challenges of the 59.94 world are addressed with this family which includes 24 Hz, 30 Hz, and 60 Hz field and frame rates. Though not used for broadcast, this family is useful for film rate and scientific/ industrial applications.

The vast majority of applications, even those including both SD and HD formats, will all fall within a single frame rate family. For example, as members of the 59.94 family, both SD 525 and 1080i/59.94 can be simultaneously vertically locked to a single reference.

Working with the Internal Test Signal Generators

The BrightEye NXT Compact Router is equipped with two independent internal Test Signal Generators (TSG). These generators are driven from the genlock source chosen by the Reference Source control on the Timing and Genlock menu.

Each TSG can be independently configured for format, Router Front Panel rate, and test pattern. The TSG outputs will always be clock-locked to the reference source. Further, they will be vertically locked and timed if the video standard the TSG is configured for is compatible with the provided reference.

Because the BrightEye NXT Router generates the test signals internally, the TSGs are available as sources in the Router (without consuming a physical input BNC) and can be selected to any output destination. Source names can be assigned to them in the Port Configuration menu, and their position on control panels is assigned in the Profiles menu.

Configuring the Internal Test Signal Generators from the Front Panel

There are two sets of configuration controls, one for each TSG, for both the BrightEye NXT front panel and the web interface. These configurations are independent, allowing the two generators to operate in different formats, and even at different frame rates. To configure them to the same standard, and to set them to matching timing (relative to the genlock reference), make the same settings for Standard, Vertical Timing, and Horizontal Timing.

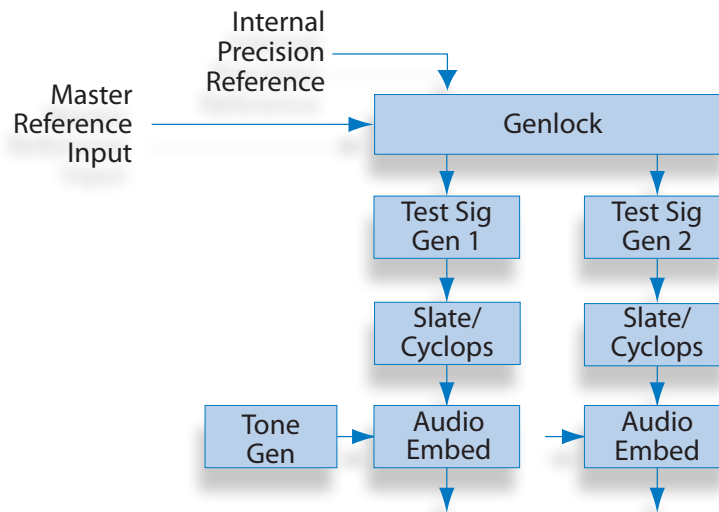

To Select the TSG Standard

1. Press the Configuration button. The top level menu display.
2. Use the up or down arrow buttons to select the top level menu for TSG1 or TSG2.
3. Press the right arrow button (or OK) to highlight the Standard submenu.
4. Press the right arrow button (or OK) to go to the Standard selection submenu.
5. Press the up or down arrow buttons to select the Standard you want to use.
6. Press OK to set your Standard selection, or press the Configuration button to cancel your selection.
7. Press the Configuration button to back out of the menu one level at a time. Or wait approximately 30 seconds until the screen automatically returns to Operational mode.

The BrightEye NXT uses the video format selection of the Primary Test Signal Generator to determine two system-wide parameters—System Frame Rate, and Vertical Interval Switch Point.

To Select the TSG Pattern

1. Press the Configuration button. The top level menu display.
2. Use the up or down arrow buttons to select the top level menu for TSG1 or TSG2.
3. Press the right arrow button (or OK) to access the top level of the submenus.
4. Use the up or down arrow buttons to highlight the Pattern submenu.
5. Press the right arrow button (or OK) to go to the Pattern selection submenu.
6. Press the up or down arrow buttons to select the Pattern you want to use.
7. Press OK to set your Pattern selection, or press the Configuration button to cancel your selection.
8. Press the Configuration button to back out of the menu one level at a time. Or wait approximately 30 seconds until the screen automatically returns to Operational mode.

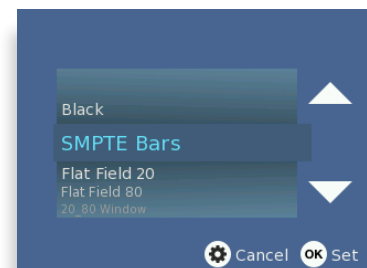
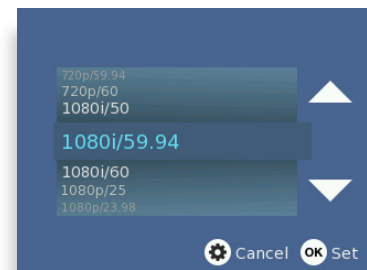

To Set the TSG Vertical Timing

1. Press the Configuration button. The top level menu display.
2. Use the up or down arrow buttons to select the top level menu for TSG1 or TSG2.
3. Press the right arrow button (or OK) to access the TSG submenus.
4. Use the up or down arrow buttons to highlight the V Timing submenu.
5. Press the right arrow button (or OK) to access the V Timing selection submenu.
6. Press the up or down arrow buttons to set the lines value you want to use. If you want to reset V Timing to zero, press both the up and down arrow buttons simultaneously.
7. Press OK to set your V Timing selection, or press the Configuration button to cancel your selection.
8. Press the Configuration button to back out of the menu one level at a time. Or wait approximately 30 seconds until the screen automatically returns to Operational mode.

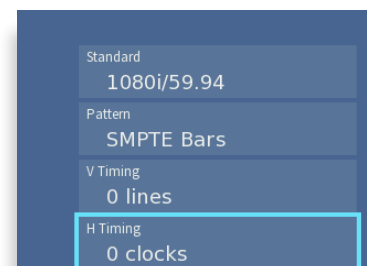
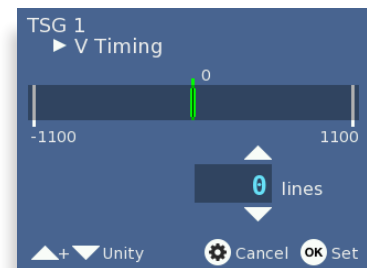
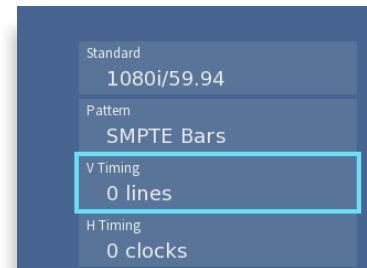

To Set the TSG Horizontal Timing

1. Press the Configuration button. The top level menu display.
2. Use the up or down arrow buttons to select the top level menu for TSG1 or TSG2.
3. Press the right arrow button (or OK) to access the TSG submenus.
4. Use the up or down arrow buttons to highlight the H Timing submenu.
5. Press the right arrow button (or OK) to access the H Timing selection submenu.
6. Press the up or down arrow buttons to set the clocks value you want to use. If you want to reset H Timing to zero, press both the up and down arrow buttons simultaneously.
7. Press OK to set your H Timing selection, or press the Configuration button to cancel your selection.
8. Press the Configuration button to back out of the menu one level at a time. Or wait approximately 30 seconds until the screen automatically returns to Operational mode.

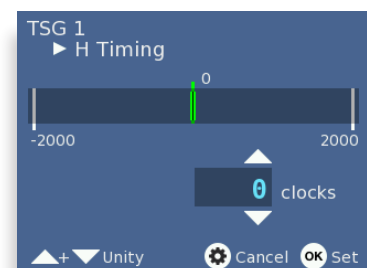

To Configure the TSG Slate

1. Press the Configuration button. The top level menu display.
2. Use the up or down arrow buttons to select the top level menu for TSG1 or TSG2.
3. Press the right arrow button (or OK) to access the TSG submenus.
4. Use the up or down arrow buttons to highlight the Slate submenu.
5. Press the right arrow button (or OK) to access the Slate On/Off selection submenu.
6. Press the up or down arrow buttons to select On or Off.
7. Press OK to set your Slate On/Off selection, or press the Configuration button to cancel your selection.
8. Press the Configuration button to back out of the menu one level at a time. Or wait approximately 30 seconds until the screen automatically returns to Operational mode.

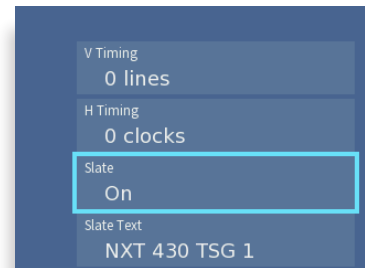

To Configure the TSG Slate Text

1. Press the Configuration button. The top level menu display.
2. Use the up or down arrow buttons to select the top level menu for TSG1 or TSG2.
3. Press the right arrow button (or OK) to access the TSG submenus.
4. Use the up or down arrow buttons to highlight the Slate Text submenu.
5. Press the right arrow button (or OK) to access the Slate Text configuration keyboard.
6. Use the up, down, left and right arrow buttons to select one letter at a time. Press OK to enter each letter, one at a time, into the text field.
7. When you have finished entering the Slate Text, highlight "Set" on the Slate Text configuration keyboard, then press OK to save your changes.
8. Press the Configuration button to back out of the menu one level at a time. Or wait approximately 30 seconds until the screen automatically returns to Operational mode.

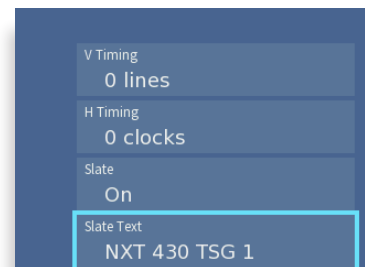

To Configure the TSG Cyclops

1. Press the Configuration button. The top level menu display.
2. Use the up or down arrow buttons to select the top level menu for TSG1 or TSG2.
3. Press the right arrow button (or OK) to access the TSG submenus.
4. Use the up or down arrow buttons to highlight the Cyclops submenu.
5. Press the right arrow button (or OK) to access the Cyclops selection submenu.
6. Press the up or down arrow buttons to select one of these options: Off, Cyclops Only, Cyclops Aud Pop, Cyclops Aud Beep.
7. Press OK to set your Cyclops selection, or press the Configuration button to cancel your selection.
8. Press the Configuration button to back out of the menu one level at a time. Or wait approximately 30 seconds until the screen automatically returns to Operational mode.

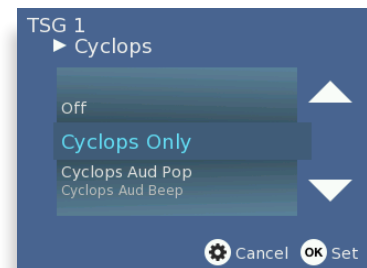
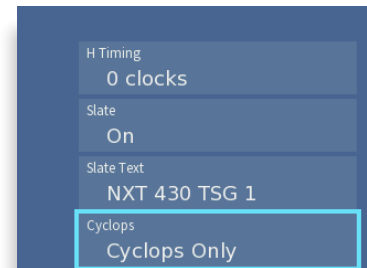

To Configure the TSG Audio Reference Level

1. Press the Configuration button. The top level menu display.
2. Use the up or down arrow buttons to select the top level menu for TSG1 or TSG2.
3. Press the right arrow button (or OK) to access the TSG submenus.
4. Use the up or down arrow buttons to highlight the Audio Ref Level submenu.
5. Press the right arrow button (or OK) to access the Audio Ref Level selection submenu.
6. Use the up or down arrow buttons to select either -20 dBFS or -18 dBFS.
7. Press OK to set your selection.
8. Press the Configuration button to back out of the menu one level at a time. Or wait approximately 30 seconds until the screen automatically returns to Operational mode.

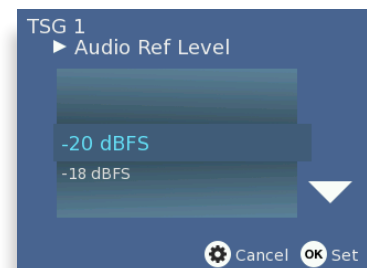
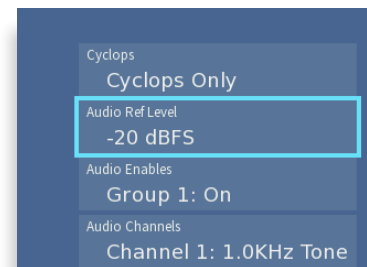

To Configure the TSG Audio Enables

1. Press the Configuration button. The top level menu display.
2. Use the up or down arrow buttons to select the top level menu for TSG1 or TSG2.
3. Press the right arrow button (or OK) to access the TSG submenus.
4. Use the up or down arrow buttons to highlight the Audio Enables submenu.
5. Press the right arrow button (or OK) to access the Audio Enables selection submenu.
6. Press the right or left arrow buttons to select Group 1, Group 2, Group 3 or Group 4.
7. Press the up or down arrow buttons to select On or Off.
8. Press OK to set your selection, or press the Configuration button to cancel your selection.
9. Press the Configuration button to back out of the menu one level at a time. Or wait approximately 30 seconds until the screen automatically returns to Operational mode.

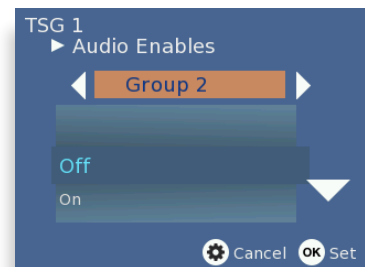
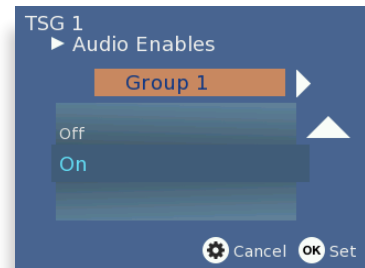
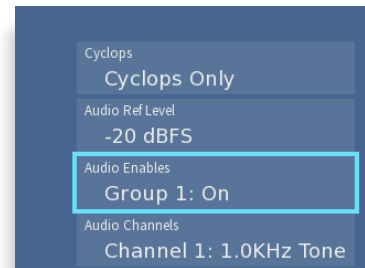

To Configure the TSG Audio Channels

1. Press the Configuration button. The top level menu display.
2. Use the up or down arrow buttons to select the top level menu for TSG1 or TSG2.
3. Press the right arrow button (or OK) to access the TSG submenus.
4. Use the up or down arrow buttons to highlight the Audio Channels submenu.
5. Press the right arrow button (or OK) to access the Audio Channels selection submenu.
6. Press the right or left arrow buttons to select a channel ranging from Channel 1 to Channel 16.
7. Press the up or down arrow buttons to select one of the available tones or Silence.
8. Press OK to set your selection, or press the Configuration button to cancel your selection.
9. Press the Configuration button to back out of the menu one level at a time. Or wait approximately 30 seconds until the screen automatically returns to Operational mode.

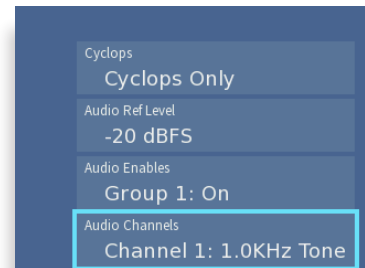

Configuring the Internal Test Signal Generators from the Web Interface

There are two sets of configuration controls, one for each TSG, for both the BrightEye NXT front panel and the web interface. These configurations are independent, allowing the two generators to operate in different formats, and even at different frame rates. To configure them to the same standard, and to set them to matching timing (relative to the genlock reference), make the same settings for Standard, Vertical Timing, and Horizontal Timing.

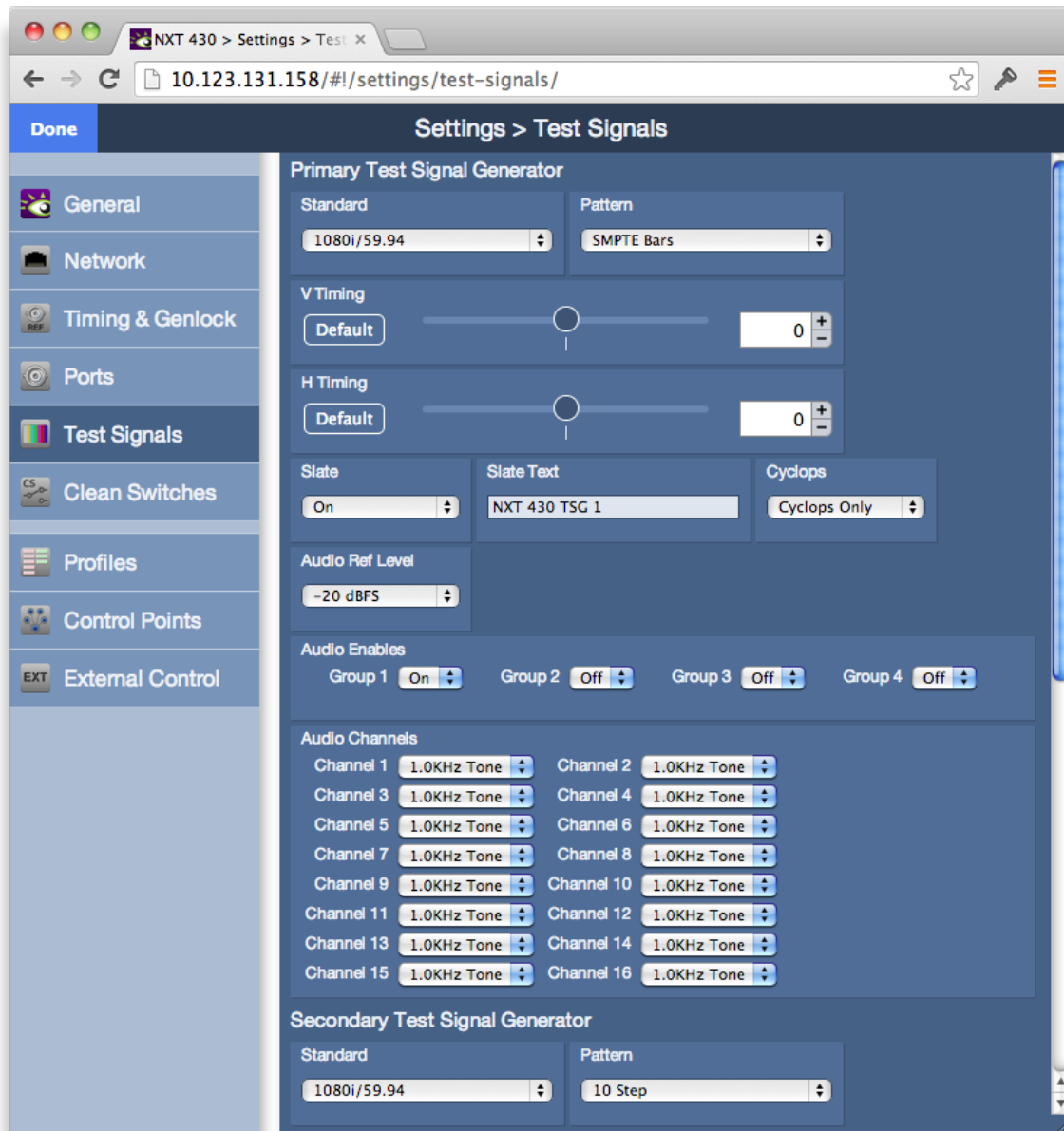

The Test Signals configuration page web interface

The configuration controls for the TSGs as are follows:

Standard

Select the desired operating format and frame rate.

Note: The choice of Standard for the Primary Test Signal Generator sets the System Frame Rate for the entire Router. This is detailed earlier in the section [Setting Up Timing and Genlock](#) on page 50.

If the Secondary TSG is set to a Standard which is incompatible with the System Frame Rate (determined by the Primary TSG), then it will have a free-running H and V. This makes it possible, for example, to produce both HD1080i/59.94 in the Primary TSG, and 1080i/50 in the Secondary TSG. Both will have the same frequency accuracy (from the genlock reference), but only one will be vertically and horizontally timeable.

Pattern

Choose the desired test pattern to be presented by the TSG.

In addition to Black and Bars, the Pathological test pattern is provided. Also known as Digital Checkfield, it is a “worst-case” signal that stresses SDI cable drivers and equalizers. It is extremely useful in proving the integrity of a system.

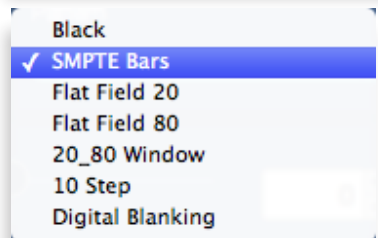
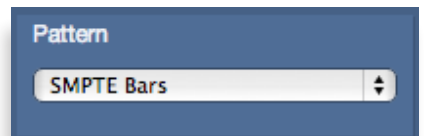
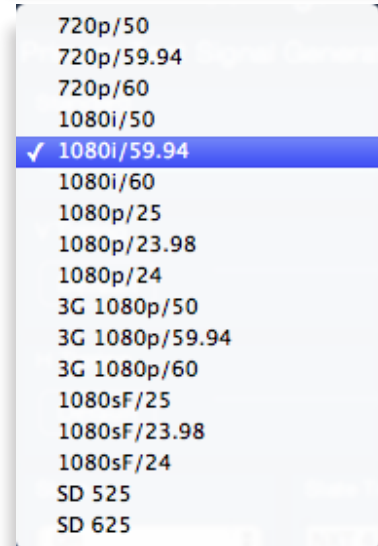
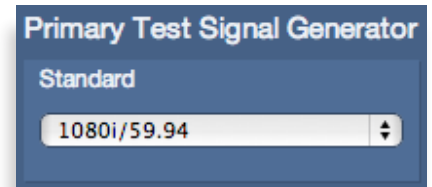

Vertical and Horizontal Timing

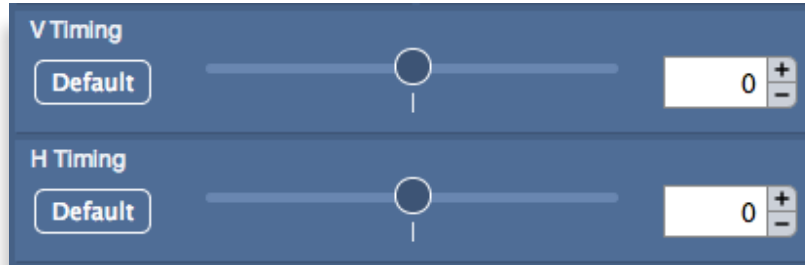

The Vertical and Horizontal Timing controls adjust the timing of the TSG relative to the genlock reference. Setting the H and V parameters to 0 will “zero” time the TSG to the reference. Negative values will cause the TSG to be early with respect to the reference; positive values will make the TSG later in time.

When the Router is being operated from an external 10 MHz reference, or when it is configured to use its internal precision frequency reference, there is no external video reference against which H and V timing can be adjusted. In that case, all of the resources in the router (the TSGs and the Clean Switch/Synchronizers) will be adjusted against a common, internally generated video timing reference. This means that they can be adjusted relative to each other. If all of their H and V Timing parameters are set to identical values (like 0), they will all be locked (synchronous) to each other and they will all be in vertical and horizontal alignment with each other.

Note: The timing adjustments for the Primary Test Signal Generator are also used to position the vertical interval switching point in the Router’s matrix. The timing of the Primary TSG can be compared to other sources on a Waveform Monitor to ensure that the switch point will be properly aligned to the sources feeding the Router.

Audio Embedding

Each TSG has an Audio Embedder (Multiplexer) that can embed 16 channels of audio into the TSG SDI output. Audio is embedded in groups, each of which contains 4 channels. There are 9 audio sources for each channel – 8 tone generators, plus silence.

Note: In the world of digital audio, there is a big difference between “Silence” and “no signal present.” In the same way that Black is a legitimate video signal, digital silence must be sent to destinations rather than just sending “nothing.” Thus, TSGs should generally be configured to embed ALL of the groups that may be in use in a facility, with Silence chosen as the audio signal for channels where no content is needed or desired. Otherwise, switching between a TSG with only one group enabled, and a source with two groups of embedded audio present, will produce undesirable effects in downstream equipment.

Audio Reference Level

This control selects the Digital Reference Level for the audio tone generators. This sets the nominal reference level (or 0 VU) relative to Digital Full Scale (DFS). This relationship is expressed on a logarithmic (decibel) scale. Since DFS is the 'loudest' signal that can be represented, a setting of -18 dBFS will be 18 dB below Full Scale which is 2dB greater than a setting of -20 dBFS. This control should be set in accordance with the audio practice in use in your facility. Frequently, -20 dBFS is the common practice in NTSC countries, while -18 dBFS is used in PAL countries.

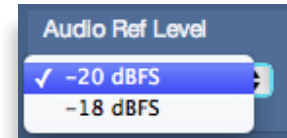

Audio Group Enable

Each of the four possible audio groups can be Enabled independently.

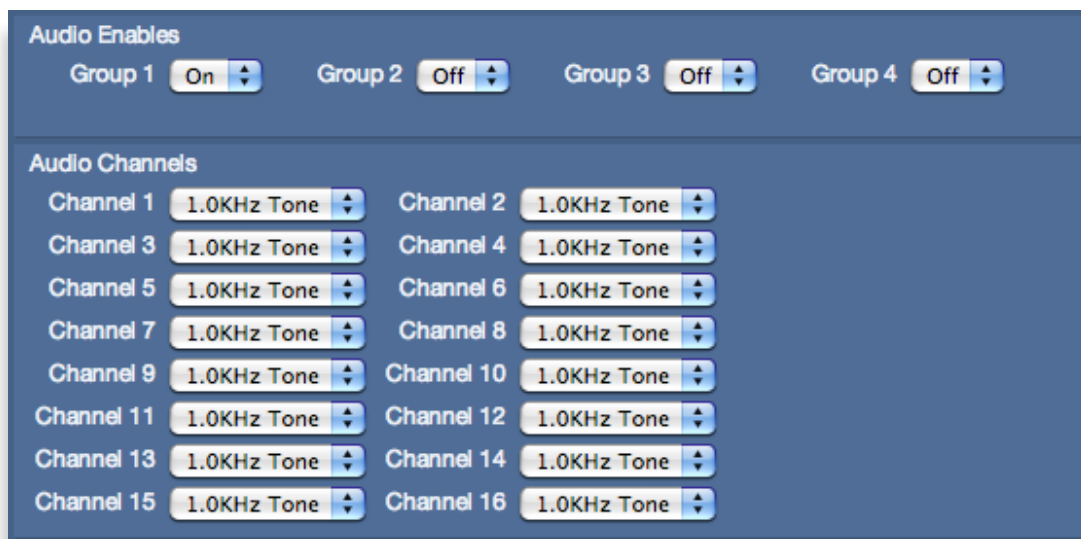

Audio Source Selection

Choose between Silence, or one of eight tone frequencies. The tone generators produce sine waves with precision at 24 bits of quantization. This can be verified with a digital audio distortion analyzer with a noise floor at -144 dBFS.

Any tones that are selected will be dynamically modified if the Cyclops control is configured for Audio Pop or Beep. (The Cyclops control adds motion, audio pop or beep, and closed caption elements to the video test signal which proves that the signal reaching a given destination is a true live signal and not a freeze frame from a frame synchronizer that has lost its input.)

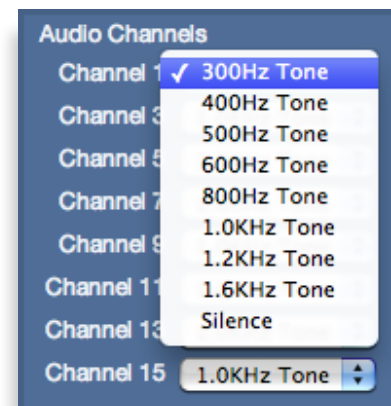

Slate On

When on, the text which has been entered in the Slate Text field will appear over top of the test pattern.

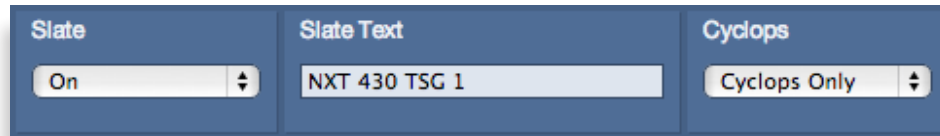

Slate Text

Enter the desired Slate text in this field, then hit the Tab key or click outside of the Slate Text field. As with all of the configuration settings in the Router, this will be saved in non-volatile memory so that it persists when the Router is powered down. The text entered in this field is not lost when the **Slate Enable** is turned off.

Cyclops

In order to produce a dynamic, constantly changing Test Pattern, enable one of the **Cyclops** modes to affect the picture, sound or both. The Cyclops feature adds a motion element which is overlaid over the test pattern video. It is located below the Slate field. The white cyclops pulse continuously sweeps horizontally back and forth in its black window. At the left and right extremes of its excursion the pulse makes a one frame bright flash.

Meanwhile, the Beep/Pop feature will add variety to the tones carried by the embedded audio. Selecting **Beep** will produce a short beep (and is otherwise silent), while **Pop** momentarily takes the selected tone to silence. Industry practice identifies odd numbered channels as carrying Left content, and even numbered channels as the Right half of a stereo program. The Pop and Beep timing in the audio follows this convention, with the odd channels being marked when the Cyclops makes its left flash, and the even channels marked when the right edge flash occurs.

Further, the 'left' channel is a single Beep/Pop, while the 'right' channel is a double Beep/Pop. This allows left/right identification even after the audio has been disembedded (demultiplexed) and has lost the implied channel association.

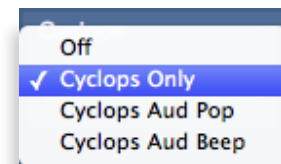

These aural and visual markers provide proof at downstream points in a transmission chain that it is producing live, uninterrupted delivery of content – even when not in active service. The precise synchronization between the visual Cyclops and the aural Beep/Pop are also useful to verify sound/picture lip-sync.

Setting Up a Web Control Point (Optional)

Because the BrightEye NXT includes the built-in front control panel, it is not required to set up a web control point. However, creating one or more web control points adds flexibility to both configuring and operating your BrightEye NXT router.

Connecting an Ethernet Cable

Your BrightEye NXT unit is equipped with an Ethernet interface. To establish network connectivity between a web control point and the BrightEye NXT, connect an Ethernet cable to the Ethernet port on the rear panel while the power is off. The Ethernet port should be connected with CAT5 or CAT6 cabling to a network Ethernet router or switch to make the BrightEye NXT accessible to computers on the network. The Ethernet port will auto-sense cable direction, so a cross-over cable is not needed.

Assigning the BrightEye NXT a New IP Address and Subnet Mask

When you initially power up the BrightEye NXT as received from the factory, it will take the self-assigned static IP address of 192.168.1.100. You must modify its IP address and subnet mask to be compatible with your network's environment. These are general instructions. We recommend that you consult your IT staff if you are uncertain about any of these network configuration settings.

To Set the IP Address

1. Press the Configuration button. The top level menu display.
2. Press the down arrow button until the Network top level menu is selected.
3. Press the right arrow button (or OK) to highlight the Address submenu.
4. Press the right arrow button (or OK) to go to the Address selection submenu.
5. Using the arrow buttons, modify the fields in the Address submenu with an IP address that is compatible with your network. For example, you may want to change the IP address to something like the following: 10.123.131.158.
6. Press OK to save the new IP address, or press the Configuration button to cancel.

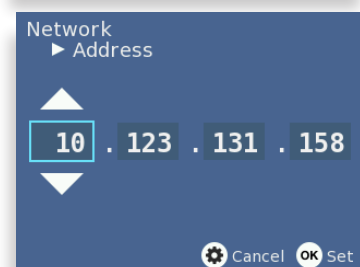
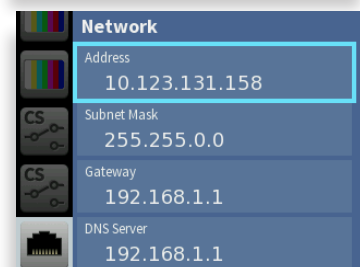

To Set the Subnet Mask

The subnet mask must be set in accordance with the size and topology of your network. The default setting as received from the factory is for a smaller network: 255.255.255.0. For a larger network, a typical setting is 255.255.0.0. If in doubt, use the setting for a larger network.

1. Press the Configuration button. The top level menus display.
2. Press the down arrow button until the Network top level menu is selected.
3. Press the right arrow button (or OK) to highlight the Address submenu.
4. Press the down arrow button to highlight the Subnet Mask submenu.
5. Press the right arrow button (or OK) to go to the Subnet Mask selection submenu.
6. Using the arrow buttons, modify the fields in the Subnet Mask submenu with an address that is compatible with your network.
7. Press OK to save the new Subnet Mask address, or press the Configuration button to cancel.

Gateway and DNS Server Settings

Set the Gateway and DNS Server parameters according to your network configuration. In general, these settings will be required only in installations with extended networking requirements, such as a remote site connected by VPN.

You can now browse to the BrightEye NXT from a computer on your network as described in the next step.



Requesting the Web Control Point

Now that you have set the BrightEye NXT's IP address in a manner that suits your network environment, you can connect to the BrightEye NXT to establish a web control point.

1. Navigate to the BrightEye NXT's new IP address with your web browser. The Control Point Needed window displays.

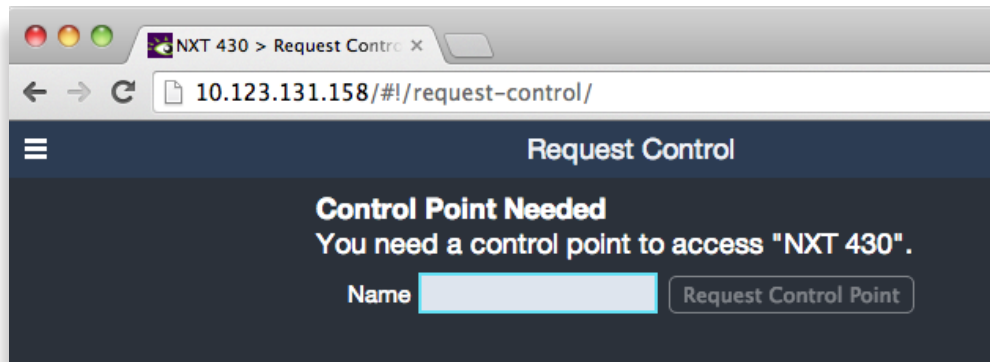

2. From the Control Point Needed window, enter the name you want to use to refer to this web control point; for example, "NXT 430 Admin."

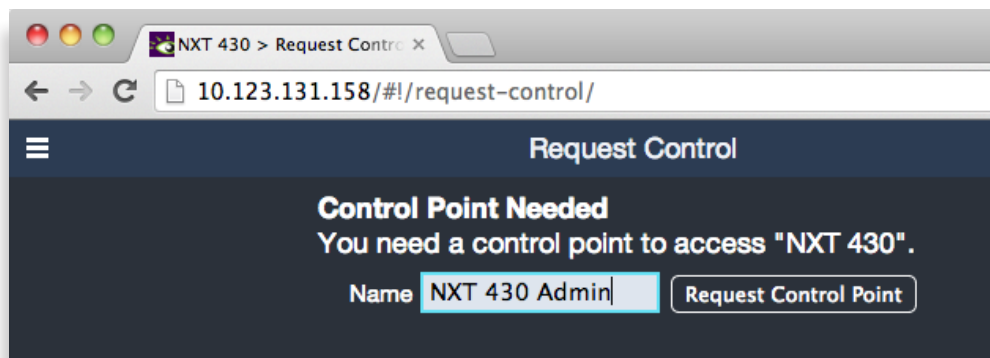

3. Click **Request Control Point**. The message "Not Authorized" displays.

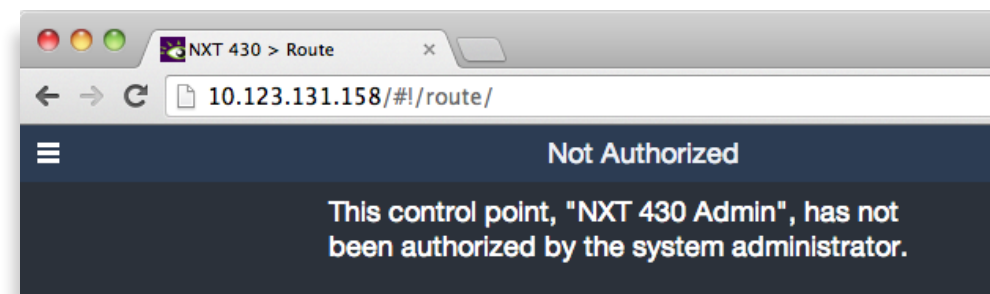

4. Click **System Settings** from the upper left part of the browser window. The Settings window displays.
5. Click **Control Points**. The Settings > Control Points window displays. The Control Point you just requested is shown.

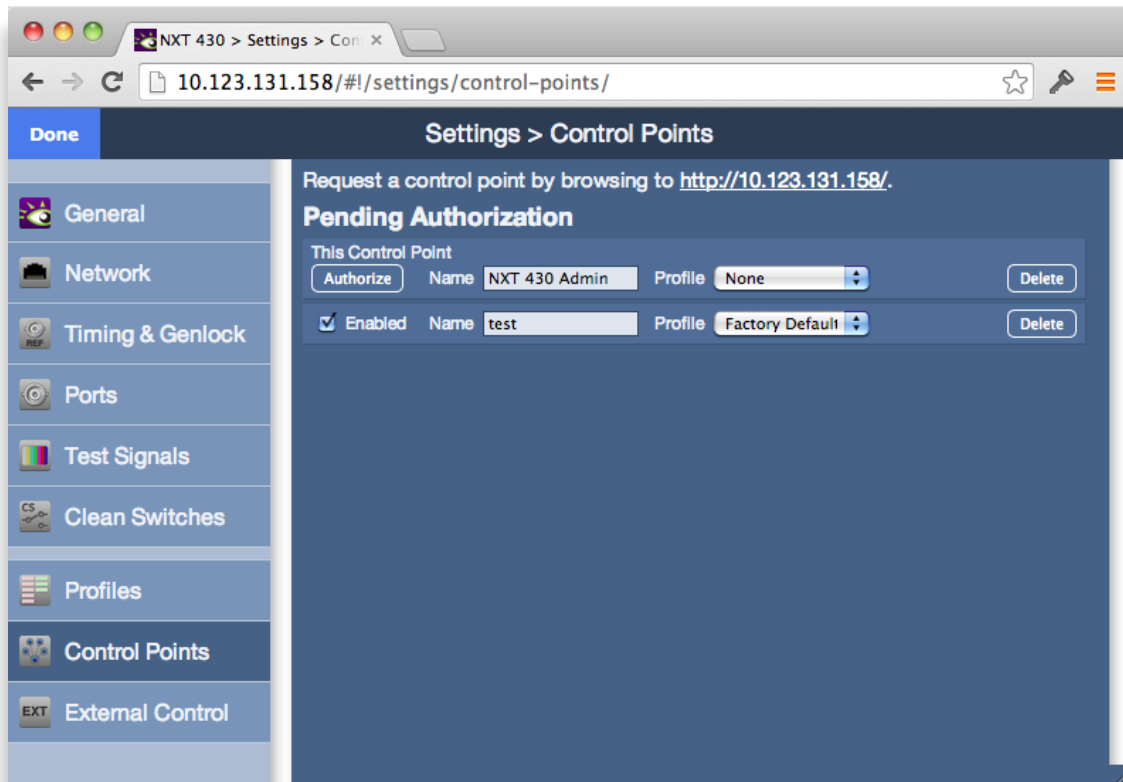
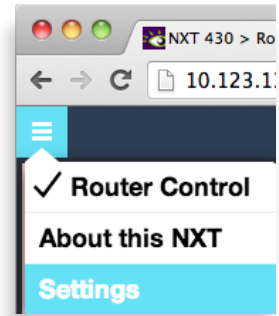

Assigning the Default Profile to the Web Control Point

Next, assign a Profile that defines which sources and destinations this Control Point can access. To begin with, choose the Factory Default Profile.

1. From the Profile drop-down control, select **FactoryDefault**.

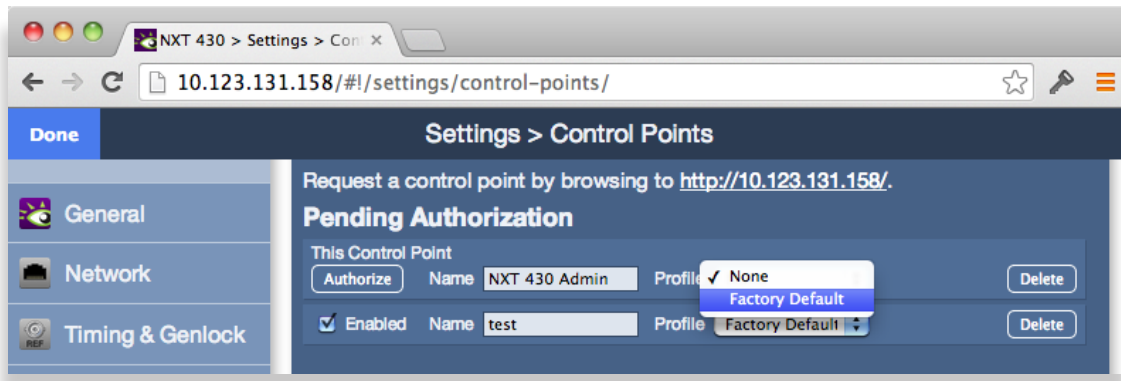

2. Click **Authorize**. The NXT Web Control Point now displays in the list of authorized Control Points.

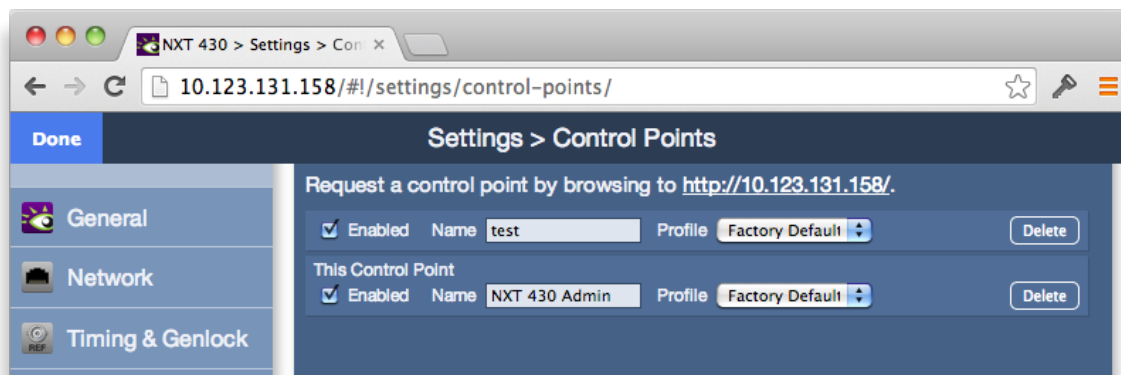

The Control Points window showing two Control Points. Note that these Control Points are enabled (the Enabled check box is selected) and have Profiles assigned to them.

3. Click **Done** in the upper left area of the window.

You are now presented with a BrightEye NXT Router control view with thumbnail icons, shown below. Without video signals present, the thumbnails will indicate "No Input."

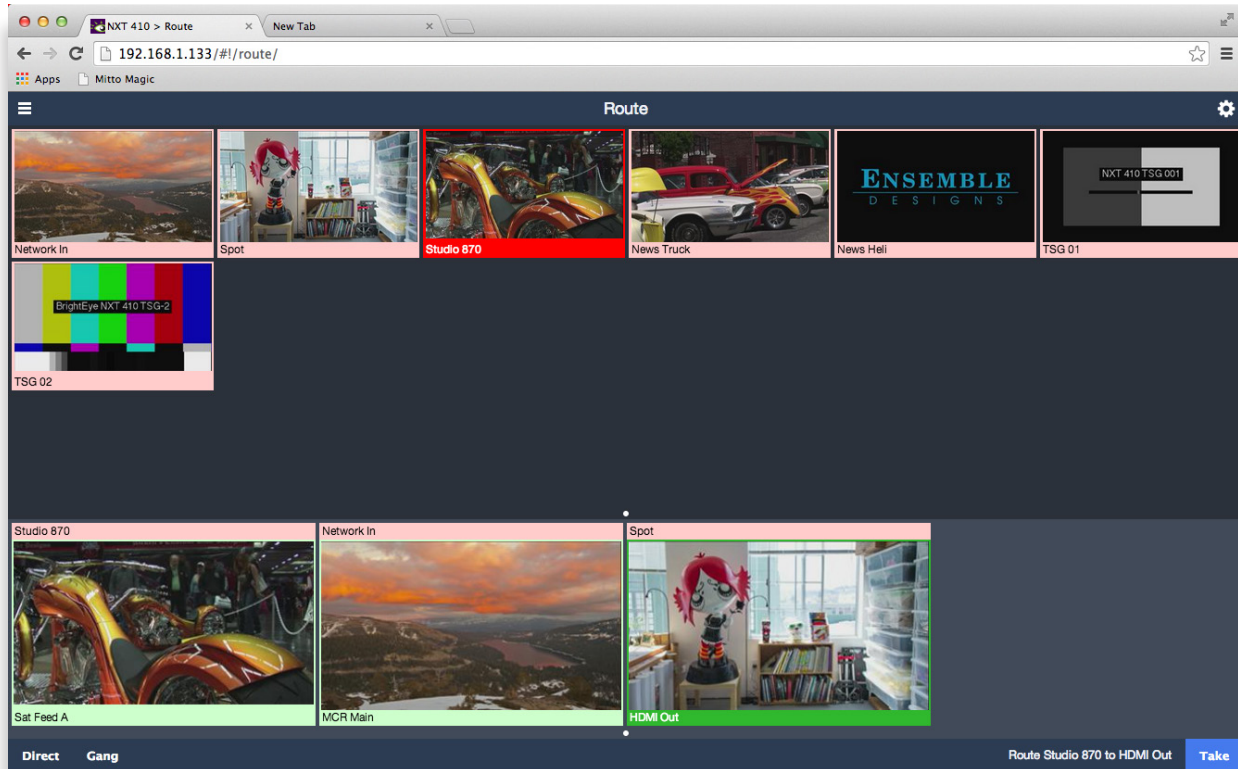

Thumbnail representations of the router's Sources are shown in the upper area, Destinations in the lower area.

Establishing Additional Web Control Points and Access Authentication

Now that you have established an initial web control point, you can create additional web control points if you need them. Access can be controlled through using a password as discussed shortly. Profile assignments also control which sources and destinations any given web control point may access.

In order to manage web access, each possible Control Point must be authenticated.

An administrator grants access to Control Points through configuring the Control Points page. Access the Control Points page by selecting **Settings > Control Points** from the left navigation panel of the web interface. The administrator assigns a previously created Profile to each of the various Control Points. Control Points can be either assigned or requested. These methods are discussed in more detail shortly.

Characteristics of Control Points

For each Control Point, only the Sources and Destinations that have been defined by its assigned Profile will be available.

For a Control Point to work, it must meet these conditions:

- It must be authenticated, meaning that the Enabled check box is selected in the Control Points window.
- It must have a Profile assigned to it.

If these conditions are not met, the browser window displays the message, "Control Point Disabled."

Examples of Control Points

- Laptops
- Desktop computers
- iPads or other tablets using a web browser
- Smartphones
- External control using serial protocols

Configuring Additional Control Points

For control points such as iPads and web browsers, there are two methods for adding them. One method is to request access from a Control Point. The other method is to assign an IP address to a Control Point.

First Method: Requesting Access from a Desired Control Point

1. From the desired control point, whether from an iPad or from a computer web browser, enter the Router's IP address (for example, <http://10.123.131.158/>) into the browser's address field. A browser window displays indicating that a Control Point is Needed.
2. Enter your desired Control Point name in the Control Point Name field, then click **Request**. The browser window indicates that your Control Point has been disabled. Your request has become a Pending Authorization item for the administrator.

Second Method: Assigning an IP Address From the Admin Control Point

To assign the IP address of a device to create a Control Point:

1. From the Admin Control Point, navigate to the IP address of the BrightEye NXT.
2. In the upper left area, click **Settings**. The Settings page displays.
3. From the left navigation panel, click **Control Points**. The Control Points page displays.
4. Under the heading Add Control Points, indicate a name in the Name field.
5. Select a profile from the Profile drop-down control.
6. Enter the IP address for the device into the Address field.
7. Click **Add**. The Control Points page refreshes to show that the newly assigned Control Point is enabled.

Approving Pending Authorizations

To approve an authorization request:

1. Click **Settings** in the upper left area of the browser.
2. Click **Control Points** in the left navigation panel. The Control Points page displays.
3. Under Pending Authorizations, you will see the request that was just submitted.
4. For this new request, select a Profile from the drop-down control.
5. Click **Authorize**. The Control Points page refreshes and now includes the newly requested Control Point.

Note: In order to access **Settings**, you must have administrator access. See [Security and Administrative Access to Settings](#) on page 78 for more details.

Number of Control Points That Can Operate Simultaneously

The BrightEye NXT performs best with a maximum of four control points operating simultaneously. The Router's data bandwidth is shared across all of the control points. Each additional control point adds an incremental load on the system. When more than four control points are being used, the BrightEye NXT's video thumbnail display performance in web browsers may begin to degrade.

Asymmetrical Bandwidth Requirements

The continuous delivery of video thumbnails to each Web Browser Control Point requires more bandwidth than is required for performing takes. The video thumbnails, comprising the vast bulk of the data, flow outward from the BrightEye NXT to each Web Control Point. The return data, in contrast, consists primarily of crosspoint commands, or takes. Because the BrightEye NXT has greater bandwidth for takes, the execution of takes will still be quite responsive even in a large system with markedly degraded video refresh performance.

Best Practice: Closing Web Browser Control Points When Not In Use

To minimize the load on the BrightEye NXT, it is recommended to close any Web Browser Control Points that are not being used.

Creating and Editing Profiles

A Profile provides each Control Point with a configured view of the Sources and Destinations on the Router. A Profile defines which Sources and Destinations can be accessed from any given Control Point.

A Profile also defines the order in which Sources and Destinations display for a Control Point. This ordering feature is of particular interest in the case of RS-232 and TCP/IP control for automation because it provides a simple means to map Sources and Destinations to suit the automation protocol.

Every Control Point, such as a web browser, an iPad, or a serial interface for external control, must have a Profile assigned to it in order for that Control Point to be able to use the Router. Multiple Control Points can share the same Profile.

Each Profile can be customized to have access to unique combinations of not only Destinations, but also Sources.

Characteristics of Profiles

- Required for every Control Point
- Show only Sources and Destinations
- Define which Sources and Destinations can be accessed
- Define the order in which Sources and Destinations are displayed
- Can be assigned to multiple Control Points

Creating an Initial Set of Profiles

Complete the process of creating as many profiles as your Router users will require. While you can always create additional Profiles or edit existing ones, you may want to systematically think through your users' needs to determine what the initial set of Profiles will be. This will simplify the overall configuration process as you begin assigning Profiles to Control Points.

To Create a Profile

1. From the left navigation panel, click **Profiles**. The Profiles page displays.
2. Enter a profile name in the New Profile field.
3. Click **Create**. The new Profile is listed on the Profiles page.
4. Next to the newly created Profile, click **Edit**. The Edit Profile page displays. At the outset of creating a new profile, all the available Sources and Destinations are presented.
5. Click and drag unassigned Sources and Destinations up to the assigned area as needed for this specific profile. Note that you can rearrange the order as desired. Additionally, you can include empty spaces to create groupings of Sources and Destinations by clicking and dragging a Space icon up to be a source or destination.
6. When finished, click **Save Changes** in the upper left part of the screen, then click **Done**.

This newly created Profile is now available to assign to one or more Control Points.

Repeat steps 1 through 6 until you have as many Profiles as you need.

Examples of Profiles

After the functions of the Ports have been defined, the available Sources and Destinations are selectively assigned to Profiles.

Ports that are configured as Follow or Unassigned are not available to a Profile since they cannot be “controlled.”

Master Control Room (MCR) 10 x 2

In the example below, there are ten Sources and two Destinations for a Master Control Room Profile named “MCR.”

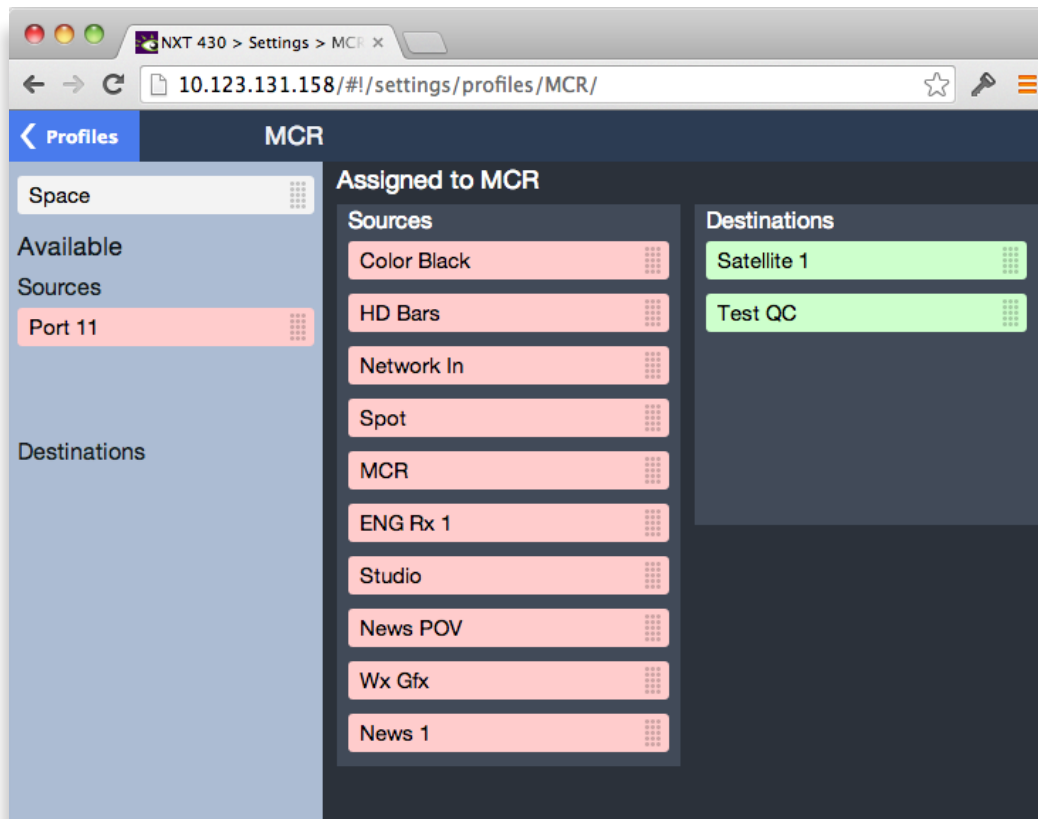

An example of a Master Control Room (MCR) Profile with 10 Sources and 2 Destinations

MCR Profile Edited and Reordered to 8 x 2

This Profile has been edited to remove access to two of the Sources (ENG Rx 1 and News 1). In addition, blank spaces have been inserted to organize the selections as they are presented on a control panel. Those “blanks” will produce unused buttons on the panel.

This profile also has the Sources and Destinations in a different order and will be reflected in the button assignment on a control panel. If this profile were assigned to the serial interface for automation control, the order and spacing of Sources and Destinations would “map” the external control to the Router.

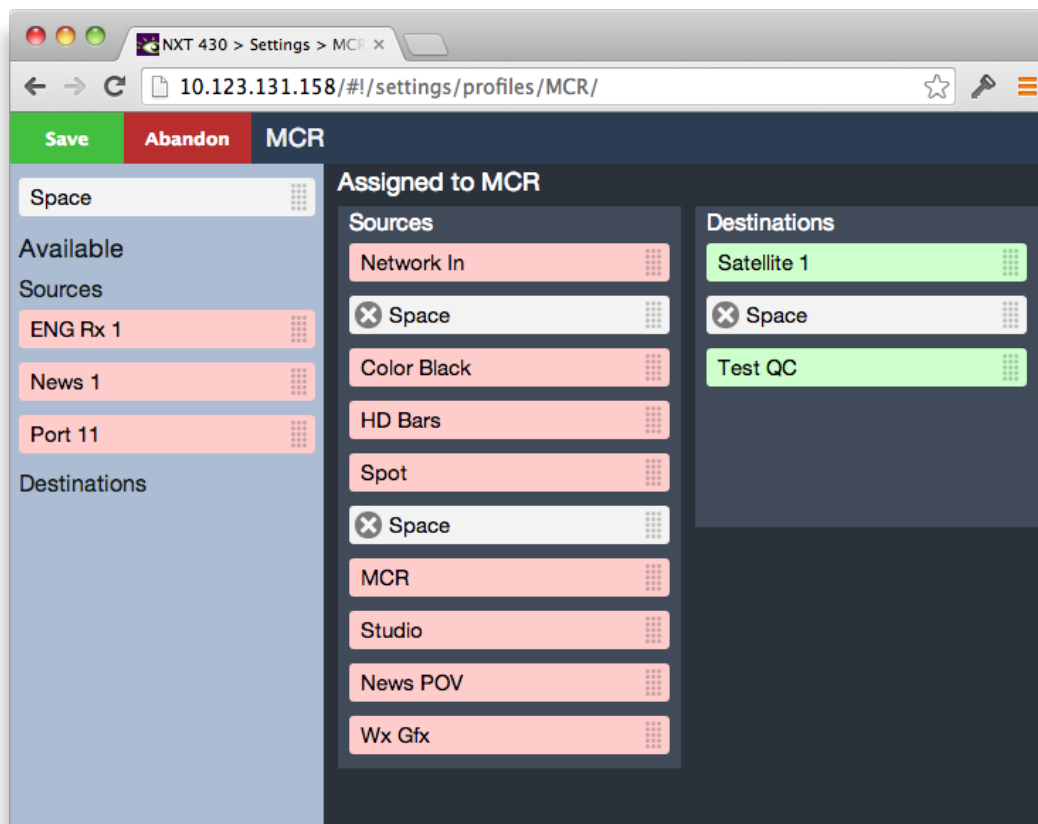

*An edited and reordered Master Control Room (MCR) Profile
with 8 Sources and 2 Destinations*

MCR Profile Edited to 8 x 1

This Profile has been further edited by removing a Destination. The result is a Profile that allows control over only a single output.

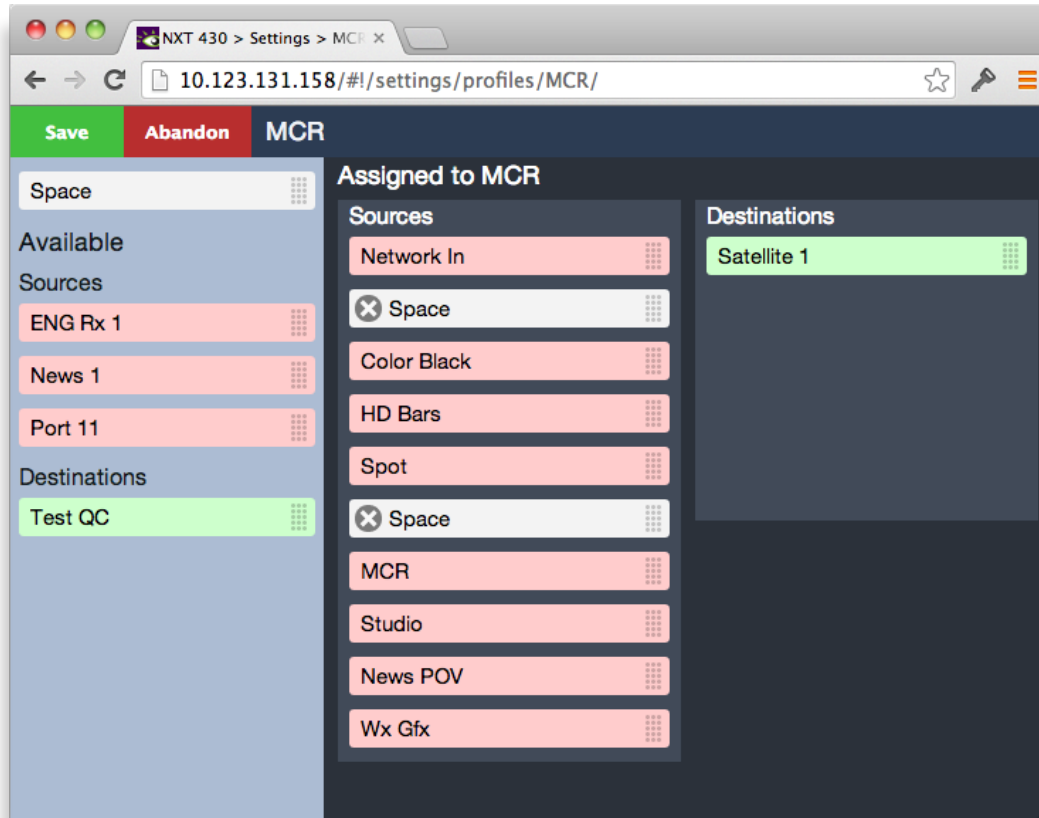

An edited Master Control Room (MCR) Profile with 8 Sources and 1 Destination

Setting Up Salvos

Salvos enable you to route a selected set of sources to a selected set of destinations simultaneously. Salvos provide an efficient method for switching among multiple sets of routing configurations with one click. You can configure and save up to eight Salvo configurations.

A single Salvo can include mixes with various duration times, direct takes, audio level adjustments and audio channel mapping settings among multiple sources and destinations.

For example, in a situation in which you need to have several different on-stage monitor configurations for a number of different uses, with Salvos set up and configured in advance, you can very efficiently switch from one multiple monitor arrangement to another.

The two methods of creating a Salvo described below are similar. The key difference is that with the first method, you start by routing all the sources you need to all the destinations in advance. Once all that is in place, you capture the whole routing configuration by clicking **Capture Current Routes** from the Salvos Editing page. If you use the second method, you determine which sources are going to which destinations from the Salvos Editing page.

To Create a Salvo

First Method

1. From the left navigation panel, click **Salvos**. The Salvos page displays.

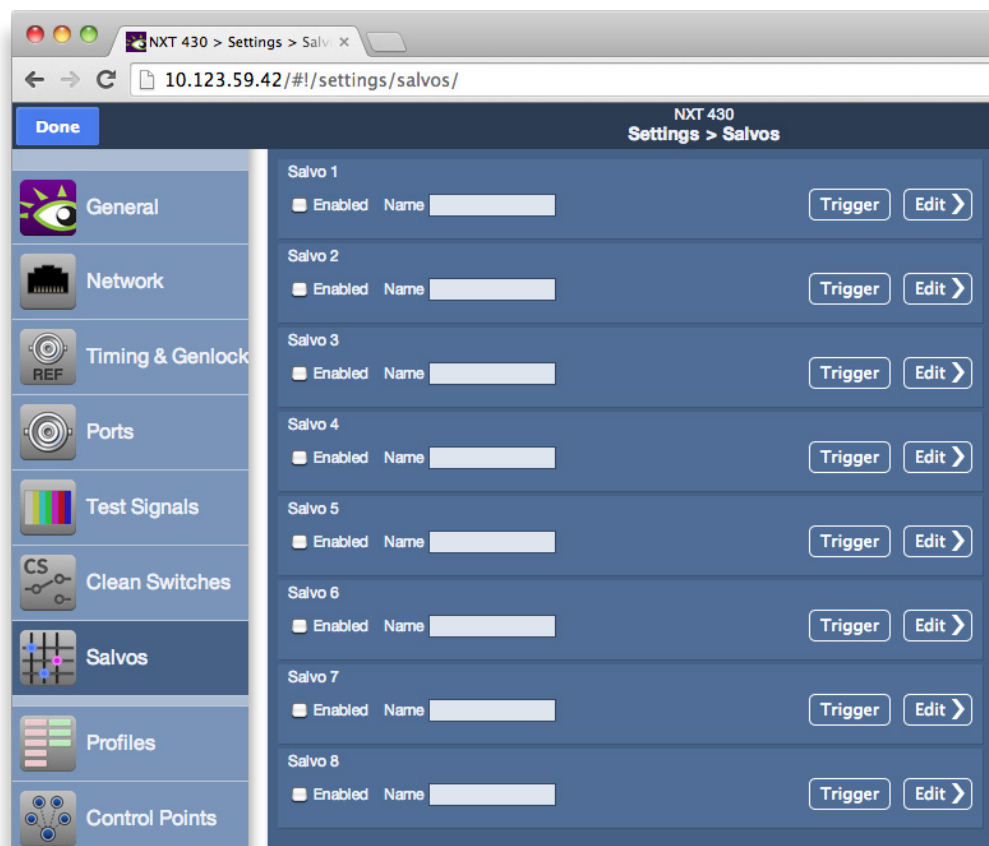

2. For the Salvo you are creating (Salvo 1 - Salvo 8), enter a name in the Name field.
3. Click **Edit**. The Salvos Editing page displays.

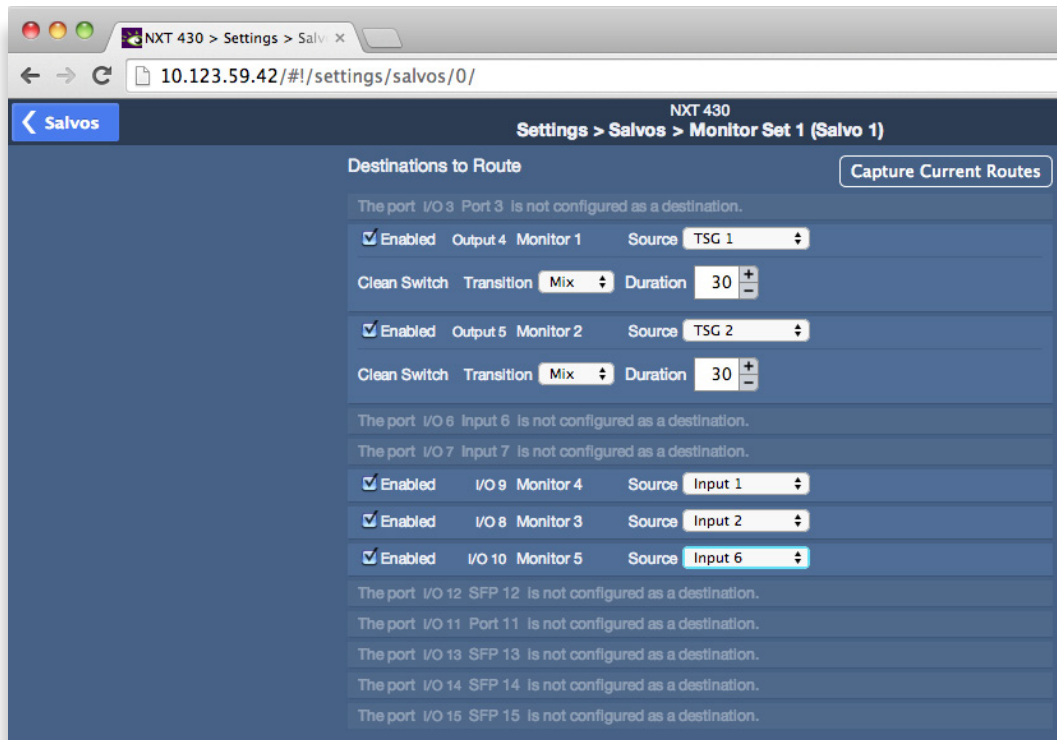

4. Using either the front panel or the web interface, route all sources and destinations as you want them to be for the specific Salvo you are creating, including any transition options for mixing, mix duration times, or taking.
5. Click the **Capture Current Routes** button. The current routing configuration is automatically saved into the Salvo settings.
6. Click Salvos in the upper left part of the screen. The Salvos page displays.
7. Repeat steps 2 through 6 until you have created as many Salvos as you need, up to a maximum of 8.
8. Click Done.

These newly created Salvos are now available to trigger from the Salvo Control page of the web interface.

Second Method

1. From the left navigation panel, click **Salvos**. The Salvos page displays.
2. Enter a name in the Name field.
3. Click **Edit**. The Salvos Editing page displays.

- At the outset of creating a new Salvo, all the available Destinations are shown. For each Destination, select the Source you want routed to it from the Source drop-down control. If a Clean Switch has been assigned to a Destination, you can specify the transition type (Mix or Take), as well as the mix duration.

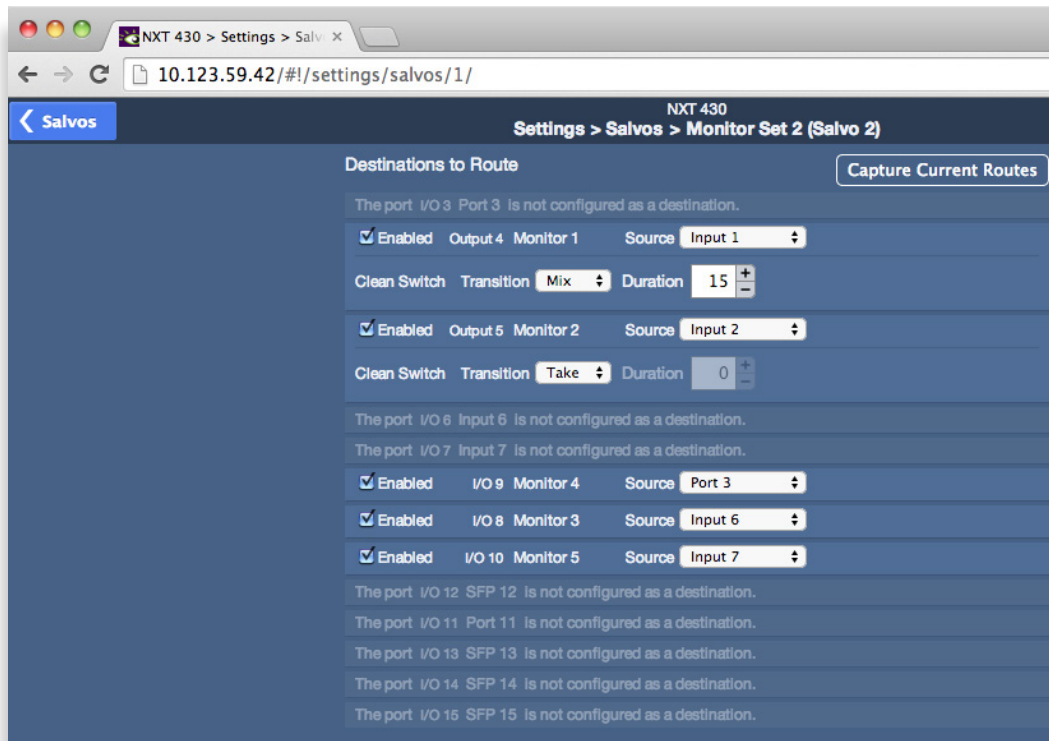

- When finished, click **Salvos** in the upper left part of the screen. The Salvos page displays.
- Repeat steps 2 through 5 until you have created as many Salvos as you need, up to a maximum of eight.
- Click Done.

These newly created Salvos are now available to trigger from the Salvo Control page of the web interface.

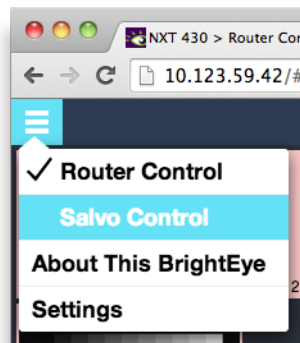

Accessing the Salvo Control page

Security and Administrative Access to Settings

All of the Router's configuration parameters can be accessed through the **Settings** button in the upper left corner of the web interface. Without enabling a password, anyone with access to the Router (meaning anyone who has an authorized Control Point with an assigned Profile) can make changes to its Settings.

Depending on the security needs of your facility, you may wish to limit access to the Router's Settings to only certain people. From the General > Settings page, you can limit administrative access to the Router by creating a password.

To Limit Access to the Router's Settings

1. From the Router's web interface, click **Settings**. The Settings > General page displays.
2. In the Security section, click the Required checkbox to enable the password functionality.

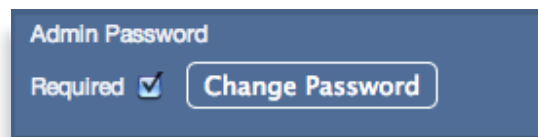

3. Select a password and enter it into the Password field. Enter it a second time in the Repeat Password field.
4. Click **Set Password**, then click **Done**. The main Router web interface displays.

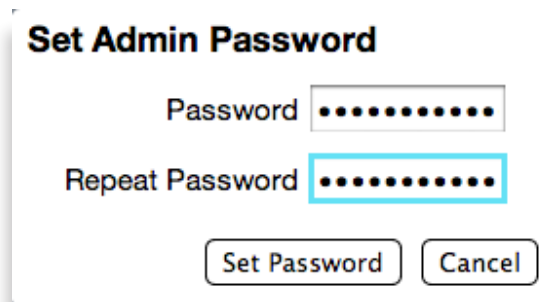

When a password is required for administrative access, users who try to access Settings will get a message that says "Password Required."

Saving and Restoring Configuration Settings

You can save and restore the configuration settings of your BrightEye NXT router. The configuration settings are downloaded as a file with a ".settings" file extension. From this file, you can upload configuration settings to one or multiple BrightEye NXT routers. The only information not stored is network settings such as the IP address and Subnet Mask.

To Save Configuration Settings

1. From the Router's web interface, click **Settings**. The Settings > General page displays.
2. In the Manage Settings section, click Download Settings. A file downloads immediately in a manner consistent with your browser's typical downloading behavior.

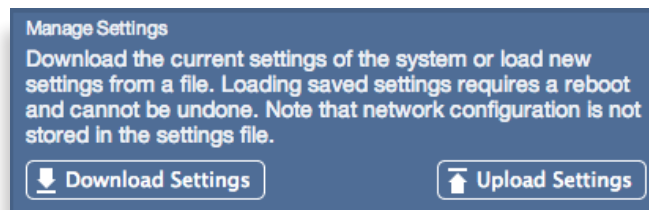

3. The configuration file is downloaded to the location where files are typically downloaded using your browser, such as your desktop or a downloads directory. The BrightEye NXT router configuration settings are stored in a file with the extension ".settings". For example:

NXT 430(NXT430-IYNT1226).settings

To Upload Configuration Settings

1. From the Router's web interface, click **Settings**. The Settings > General page displays.
2. In the Manage Settings section, click Upload Settings. A navigation window opens.
3. Navigate to the location of your configuration file, select the file, then click Open. The following message displays:

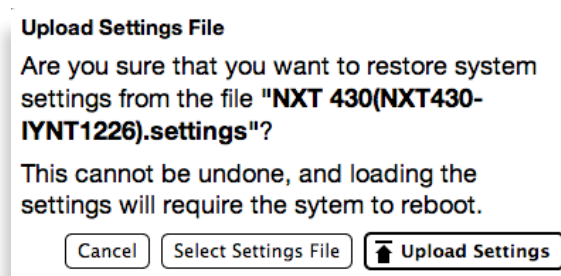

4. Click **Upload Settings**. Your browser window will lose its connection to the BrightEye NXT during the configuration file upload. The uploading process takes a few moments.
5. After your BrightEye NXT router has rebooted, you will need to restore its network settings. See ["Assigning the BrightEye NXT a New IP Address and Subnet Mask" on page 62](#) for instructions about that process.

Chapter 5: Operations and Step-by-Step Procedures

In this Chapter

This chapter covers the following topics:

- [Operations Using the Front Control Panel](#)
- [Operations Using a Web Control Point](#)

This chapter provides complete step-by-step procedures for each task that you can perform with the BrightEye NXT using the following control choices:

- BrightEye NXT Router Operation Using its Front Panel
- BrightEye NXT Router Operation with the Web Browser Interface

You can use the web browser interface on a desktop computer, tablet or smartphone.

For serial protocols through TCP/IP and RS-232, please see [Chapter 6: External Control](#) on page 92.

Operations Using the Front Control Panel

After setting up and configuring the BrightEye NXT, you can start routing sources to destinations. First we will address how to do this using the front panel. Next, we will address how to do this using the web interface.

Making a Cross Point Switch in Preset/Take Panel Mode

When using the front panel, always select the destination first, then the source, then press **Take**.

Selecting a Destination

There are two methods for selecting a destination from the front panel:

1. If you have assigned the destination you want to select to a shortcut key, pressing that shortcut key selects it. The signal will display on the screen.
2. Otherwise, press **Dest** to step through all available destinations until you see the one you want displaying on the screen.

Selecting a Source

Similarly, there are two methods for selecting a source from the front panel:

1. If you have assigned the source you want to select to a shortcut key, pressing that shortcut key selects it. The signal will display on the screen.
2. Otherwise, press **Src** to step through all available sources until you see the one you want displaying on the screen.

Pressing Take

After first selecting the destination, then the source, both the **Take** button and the selected source shortcut button blink to show that a Take is available. At that point, pressing **Take** sends the selected source to the selected destination. The screen displays the video signal, showing the source and its port name along the top red header and the destination and its port name along the bottom green footer.

Performing Direct Takes

Using Direct Take mode, you can change which source is going to a destination by pushing an assigned source shortcut button. A cross point switch is made directly without pressing **Take**.

To Enter Direct Take Panel Mode

- When the BrightEye NXT is not in Direct Take mode, the **Take** button illuminates blue.
- Double-tap the blue illuminated **Take** button. The message "Panel Mode Direct Take" displays very briefly on the front panel screen.
- The **Take** button stops illuminating.

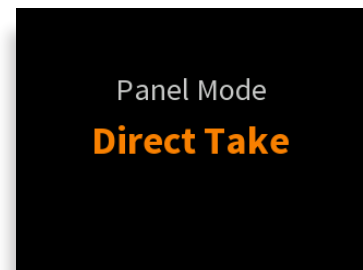

To Make a Direct Take

The currently selected destination shortcut button illuminates bright green. The source shortcut button that is currently going to the selected destination illuminates bright red.

To make a direct take, press a different source shortcut button. The source assigned to that shortcut button is immediately routed to the already-selected destination.

To Exit Direct Take Panel Mode

- Double-tap the **Take** button. The message "Panel Mode Preset / Take" displays very briefly on the front panel screen.
- The **Take** button illuminates blue.

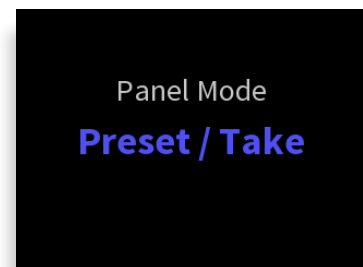

Performing Mix Takes with the Front Panel

Clean Switch Required

In order to perform a Mix take, the destination must have a Clean Switch assigned to it. (BrightEye NXT 410, BrightEye NXT 410-H and BrightEye NXT 430 only.)

To Enter Mix Mode

For this example, Clean Switch 1 is assigned to Output 4, and the Clean Switch is configured for Audio Follow Video.

- When the BrightEye NXT is not in Mix mode, the footer will be blue and will indicate "Cut CS1 / AFV".
- Double-tap the assigned destination shortcut button. The message "Changing Output 4 Transition to: Mix" displays very briefly on the front panel screen.
- The footer, now purple, indicates "Mix CS1 / AFV".

To Make a Mix Take

The currently selected destination shortcut button illuminates bright green. The source shortcut button that is currently going to the selected destination illuminates bright red.

To make a mix take, press a different source shortcut button. The source assigned to that shortcut button is immediately routed to the already-selected destination. The mix will occur with the mix duration specified from the **Panel Config > Tran Duration** menu.

To Exit Mix Mode

- Double-tap the assigned destination shortcut button. The message "Changing Output 4 Transition to: Cut" displays very briefly on the front panel screen.
- The footer is now blue, and indicates "Cut CS1 / AFV".

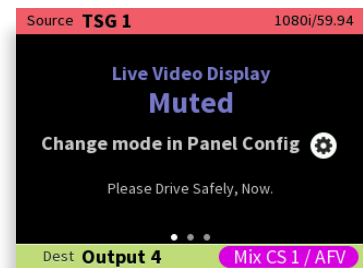

Viewing Information about a Routed Signal

To view information about a signal that is already being routed to a destination, press the green **Shortcut** button that corresponds to the signal you want information about. The associated red button illuminates to show which source is currently routed to that destination.

Additionally, pressing the Right or Left arrow buttons brings up signal metadata to the screen. The metadata includes horizontal and vertical timing, signal frame rate and other signal metadata.

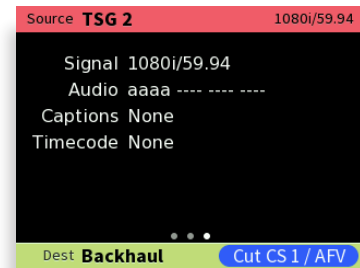
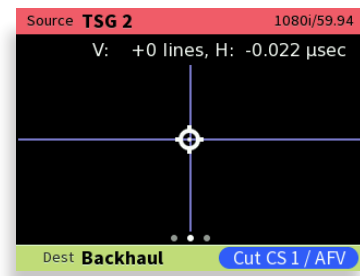

Disabling the Front Panel for Safe Driving Mode

If you will be using the BrightEye NXT router while driving a vehicle, you can put the front panel screen into “safe driving mode,” meaning that it will not display live video. Instead, it will display the message “Live Video Display Muted.”

To Enter Safe Driving Mode

1. Press the Configuration button. The top level menu displays.
2. Use the up or down arrow buttons to select the top level menu for Panel Config.
3. Press the right arrow button (or OK) to access the Panel Config submenu.
4. Press the down arrow button repeatedly until the Live Video Display submenu is highlighted.
5. Press the right arrow button (or OK) to access the next Live Video Display submenu.
6. Press the up or down arrow to select either Live Video Muted or Live Video On.
7. Press OK to set your selection, or press the Configuration button to cancel your selection.
8. Press the Configuration button to back out of the menu one level at a time. Or wait approximately 30 seconds until the screen automatically returns to Operational mode.

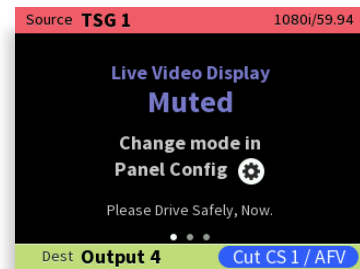

Operations Using a Web Control Point

You can control the BrightEye NXT through its web browser user interface to perform takes, direct takes, gang, and gang combined with direct takes.

Prerequisites

Before you can access the Router through a web browser, you need to have access to an authenticated Control Point and the Router's IP address. For further details about these requirements, please see the following sections:

- [Setting Up a Web Control Point \(Optional\) on page 62](#)
- [Establishing Additional Web Control Points and Access Authentication on page 68](#)

Accessing the Web Browser Control Interface

To access the NXT web browser control interface, enter the NXT's IP address into the browser's address bar. The NXT's router interface displays, showing Sources in the upper area and Destinations in the lower area.

Performing Takes

While performing a take is a straight forward task, it can be done using more than one method.

To Perform a Take by Selecting a Source and a Destination

1. Select a Source by clicking one of the Source thumbnail images. The thumbnail frame turns red to indicate that it is selected.
2. Select a Destination by clicking one of the Destination thumbnail images. The thumbnail frame turns green to indicate that it is selected. As soon as you have selected both a Source and a Destination, the **Take** button turns blue, indicating that the Router is ready for a Take.
3. Click **Take** in the lower right area of the web browser. Your chosen Source is routed to the Destination you selected. The Destination thumbnail image updates to reflect your currently selected Source. The **Take** button is now greyed out.

To Perform a Take by Selecting Only a New Source

As long as the Destination that you want is already selected, you can do a Take by selecting a new Source, then clicking **Take**.

1. Leaving the Destination selection unchanged, select a new Source.
2. Click **Take**. Your chosen Source is routed to the Destination. The Destination thumbnail image updates to reflect your new Source selection.

Performing Direct Takes

In Direct Take mode, you leave the same Destination selected while selecting different Sources with only one click. There is no need to click the **Take** button when in Direct Take mode.

To Perform a Direct Take

1. Click **Direct** in the lower left area of the browser window. The **Direct** button turns orange.
2. Select a Destination.
3. Select a Source. The Source is immediately routed to the Destination. The Destination thumbnail image reflects your newly selected Source.

As long as you remain in Direct Take mode, you can continue to change Sources for the same Destination with only one click.

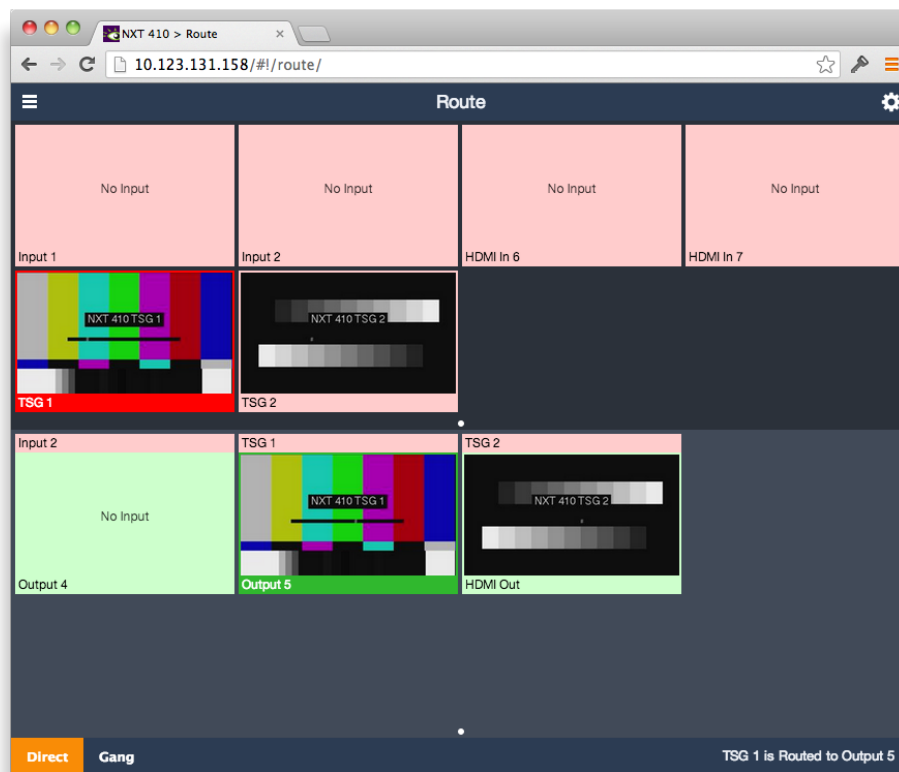

To Exit Direct Take Mode

Click **Direct** in the lower left area of the browser window. The **Direct** button is now greyed out, indicating that you are no longer in Direct Take mode.

Performing Gang Takes

Gang Takes involve routing one Source at a time to a set of Destinations.

To Perform a Gang Take

1. Click **Gang** in the lower left area of the browser window. The **Gang** button turns orange.
2. Select a Source by clicking one of the Source thumbnail images. The thumbnail frame turns red to indicate that it is selected.
3. Select a set of Destinations by clicking multiple Destination thumbnail images sequentially. The first thumbnail frame you select turns green; the remaining thumbnails you select turn yellow.
4. Click **Take** in the lower right area of the web browser. The Source is routed to the set of Destinations. The set of selected Destination thumbnail images updates to reflect your selected Source. The **Take** button is now greyed out.

You can continue to perform gang takes in this manner as long as you are in Gang mode.

To Exit Gang Mode

Click **Gang** in the lower left area of the browser window. The **Gang** button is now greyed out, indicating that you are no longer in Gang Mode.

Performing Direct Gang Takes

Direct Gang Takes involve routing one Source at a time to a set of Destinations instantaneously, without having to use the **Take** button.

To Perform a Direct Gang Take

1. Click **Direct** in the lower left area of the browser window. The **Direct** button turns orange.
2. Click **Gang** in the lower left area of the browser window. The **Gang** button turns orange.
3. Select a set of Destinations by clicking multiple Destination thumbnail images sequentially. The first thumbnail frame you select turns green; the remaining thumbnails you select turn yellow.
4. Select a Source by clicking one of the Source thumbnail images. The Source is routed to the set of Destinations. The set of selected Destination thumbnail images updates to reflect your selected Source.

To Exit Direct Gang Mode

Click **Direct** and **Gang** in the lower left area of the browser window. The **Direct** and **Gang** buttons are now greyed out, indicating that you are no longer in Direct Gang Mode.

Performing Mix Takes

Clean Switch Required

In order to perform a Mix take, the destination must have a Clean Switch assigned to it. (BrightEye NXT 410, BrightEye NXT 410-H and BrightEye NXT 430 only.) When a Clean Switch is assigned to a destination, the thumbnail of the destination in the web browser has CS1 or CS2 in its footer:

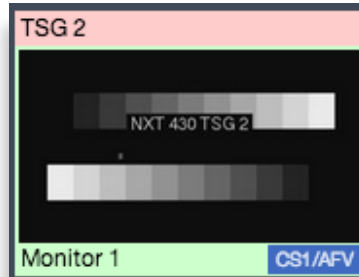

To Perform a Mix Take

1. Select the thumbnail for the destination.
2. Select the thumbnail for the source. The lower right corner of the web browser interface shows the Mix Duration indicator and the Mix button.



Note that you can modify the mix duration by entering a new number (5 to 999) in the mix duration box.

3. Select Mix. The source is mixed to the destination with the specified mix duration. When applicable, the audio output will properly mix between the adjusted audio settings of one input to the adjusted audio settings of the new source.

Keyboard Shortcuts for the Web Interface

When using the BrightEye NXT Router Control page of the web interface, you can control routing through the following keyboard shortcuts.

Selecting Sources

Use the number keys to select Sources. For example, select Input 2 with the "2" key.

Selecting Destinations

Use the "shift" key in combination with the number keys to select Destinations. For example, to select Output 4, while holding the "shift" key, press the "4" key.

Performing a Take

After you have selected both a Source and a Destination, perform a take by pressing the "return" key.

Performing a Mix

If the selected Destination has a Clean Switch assigned to it, you can perform a mix by pressing the "m" key.

Performing a Direct Take

You can toggle into Direct mode by pressing the "d" key.

Gang Selections

Toggle into Gang selection mode by pressing the "g" key.

Using Salvos

Salvos enable you to route a selected set of sources to a selected set of destinations simultaneously. Salvos provide an efficient method for switching among multiple sets of routing configurations with one click. You can configure and save up to eight Salvos.

A single Salvo can include mixes with various duration times, direct takes, audio level adjustments and audio channel mapping settings among multiple sources and destinations.

For example, in a situation in which you need to have several different on-stage monitor configurations for a number of different uses, with Salvos set up and configured in advance, you can very efficiently switch from one multiple monitor configuration to another.

To Perform a Salvo

1. Select **Salvo Control** from the pull-down menu in upper left area of the browser window. The Salvo Control page displays.
2. Click on the Salvo icon that you want to perform. That Salvo is triggered, causing the selected set of sources to be routed to the selected set of destinations simultaneously according to how the Salvo was configured.

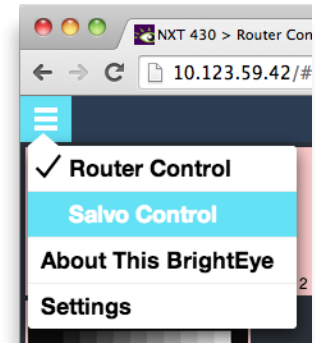

Salvo Keyboard Shortcuts

You can use the keyboard to control the Salvo Control page. Salvos are triggered by the number keys. For example, press the "2" key to trigger Salvo 2.

See also: ["Setting Up Salvos" on page 75.](#)

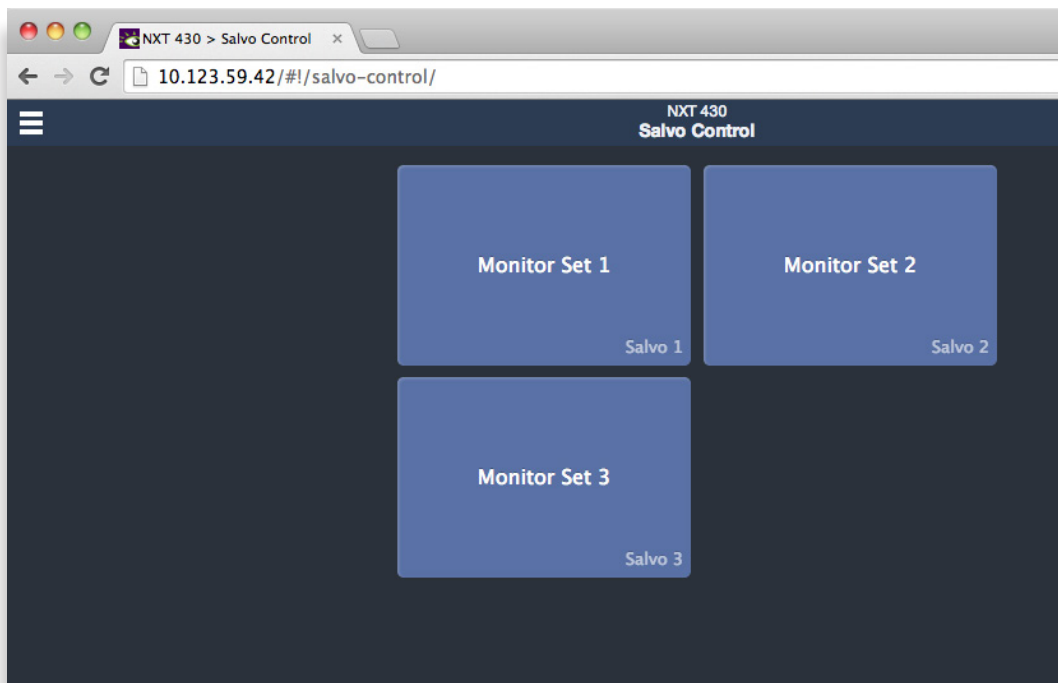

The Salvo Control page

Display Preferences

Use the **Display Preferences** button, located in the upper right area of the browser window, to customize how the thumbnail images display. Sources and Destinations can be sized independently.

Choose among three layout options for sources and destinations by clicking on the one you prefer.

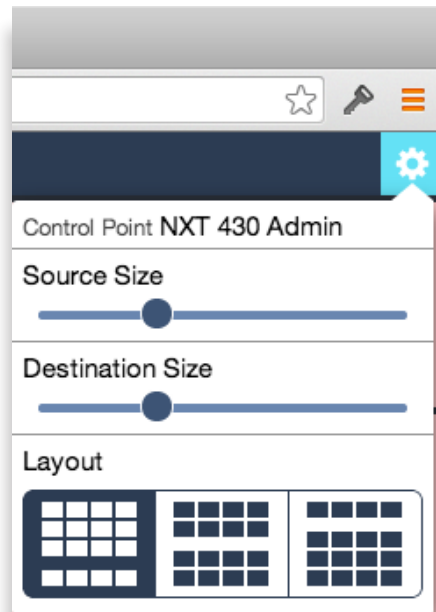

Chapter 6: External Control

The BrightEye NXT's Approach to Control Integration

The BrightEye NXT provides control from external systems like automation and event controllers. As there is a significant legacy of protocols and usage models in current practice, the BrightEye NXT supports a variety of external control protocols, offering a range of commands and control capabilities in order to make control integration as easy as possible. These protocols can be used with the Ethernet interface. This approach generally allows the Router to be used without adaption in current systems.

RS-232 Interface Option

If requested at the time of ordering, the BrightEye NXT router can include an adaptor cable that provides a 9-pin female D connector for the RS-232 interface.

9-Pin D Connector Pin Out

The pin-out for the 9-pin female D connector is as follows:

9 pin female D connector

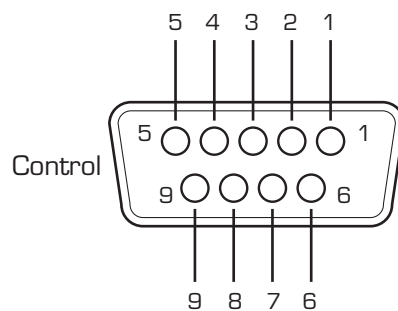

PIN	FUNCTION
1	
2	TX - Data output
3	RX - Data input
4	
5	Gnd
6	
7	
8	
9	

Supported Control Protocols Overview

The BrightEye NXT supports the following control protocols:

- GV TEN-XL (ASCII)
- GV Performer (ASCII)
- GV Native (ASCII)
- Generic ASCII
- GV TEN-XL (Binary)
- GV 100 (Binary)

GV TEN-XL

The Router supports both the ASCII (human readable) and SMPTE ESbus (binary) variants of this protocol. Supports only source to destination control.

Generic ASCII

The Router supports this simple human readable protocol with both space and comma variable separators. Supports source to destination routing and salvos.

GV 100

The Router supports SMPTE ESbus with and without the “break” character requirement. Though widely implemented, this protocol is limited in usefulness with a router because it supports only 4 output busses. It supports only source to destination control.

Software Development Kit (SDK)

When control requirements go beyond straight forward functions, such as source to destination routing and salvo execution, you may need to develop an interface more specific to your needs. To that end, Ensemble Designs will be releasing an interface design guide, or software development kit (SDK), to support such efforts.

Accessing Features Unique to the BrightEye NXT Compact Routers

That more extensive interface will be necessary when you need to access features unique to the BrightEye NXT Compact Routers, such as:

- reading the input signal metadata;
- controlling the internal TSGs; and
- capturing video thumbnails remotely

Configuring External Control

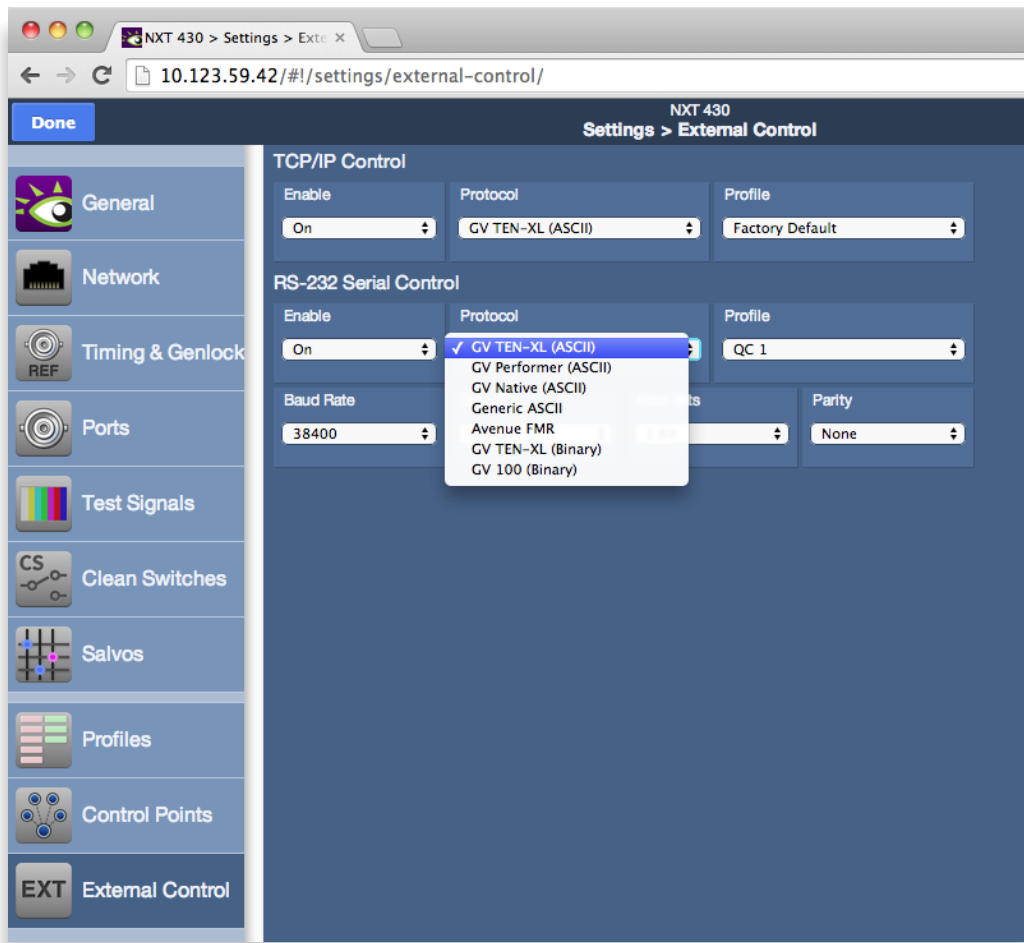

From the Protocol menu, select the desired protocol. The mapping of that protocol to Sources and Destinations will be controlled by the Profile that is assigned to the interface. Any Profile can be edited to modify the Sources and Destinations that are available to it and the order in which they are listed. For more information, see [Creating and Editing Profiles](#) on page 71.

Automation Protocols

Revision 1.1

Introduction

This section describes the various communication protocols available in the BrightEye NXT Compact Router to support external control by an automation system. It also discusses the various means for connecting an external controller to the router.

The intended audience is the developer tasked with connecting an external control device to the router.

Some discussion of configuration of the BrightEye NXT Router is covered in this section, but only as it pertains to attaching an external control device. It is recommended that the reader be familiar with general router configuration procedures as described earlier in this manual.

Conventions

This following table describes the conventions used in this section.

- A number followed by the letter “H” is a hexadecimal number. E.g., 12H is the hexadecimal equivalent of decimal 18.
- Command syntax in this section is described using a notation similar to BNF (Backus-Naur Form).

<symbol>	A symbol is represented by the symbol name inside of arrow brackets '<' and '>'.
[optional]	Optional parts are shown inside of square brackets.
...	Items that can be repeated are indicated by an ellipsis.
literals	Characters, numbers, and strings of text that are not part of a symbol are to be interpreted literally. They would be typed exactly as they are shown.
'>'	Single quotes may be used in certain cases to avoid ambiguity when a character needs to be typed literally. For example, since the arrow bracket is normally used to indicate a symbol, enclosing it in single quotes means it should be interpreted literally as the arrow bracket character. In this case it should be typed as a single character (without the quotes).

Syntax Example:

```
@<Space>X:<Lvls>/<Dest>,<Src>[/<Dest>,<Src>...]<CR>
```

The symbols in the above example are <Space>, <Lvls>, <Dest>, <Src>, and <CR>. The meaning of symbols like these will be defined as they occur throughout this document.

The optional portion in the example (enclosed in square brackets), shows that an additional “/<Dest>,<Src>” element may be present. It also indicates (with the ellipse character) that this optional element may occur repeatedly.

The following characters in the example are literals and should be typed as they appear (no quotes):

```
'@','X','/',';', and ''
```

Overview

The BrightEye NXT 415 and BrightEye NXT 430 have 2 fixed input BNCs, 2 fixed output BNCs and 7 independently assignable BNCs that can be configured as inputs or outputs. The two SFP (small format pluggable) cages can be populated with dual SFPs that have fiber optic or other connectors.

The BrightEye NXT 410 has 2 fixed input BNCs, 2 fixed output BNCs, and 1 assignable BNC that can be configured as an input or an output. There are also 4 fixed input HDMI ports, 1 fixed output HDMI port, and 1 SFP cage that can be populated with dual SFPs.

In addition to the configurability of the ports, the presentation of these inputs and outputs to a control point (e.g., control panel, web browser, automation system, etc.) is also configurable. This presentation is managed through a Profile—a map of the sources (inputs) and destinations (outputs) that are available to a control point. The Profile also determines the order in which the sources and destinations appear. These Profiles thereby provide the flexibility for every control point to have its own view (or a shared view) of the organization of inputs and outputs. The use of Profiles to order the inputs and destinations is of particular interest for installations using automation systems. (For details, refer to “[Understanding Profiles](#)” on page 97.)

Before You Begin

Some configuration of the BrightEye NXT Router will be required in order to control it from an external device such as an automation system.

In order to configure the router, you will need to establish an IP Address for the BrightEye NXT Router and browse to the BrightEye NXT’s web page from a computer. The details for doing this are covered in “[Chapter 4: Configuration](#)” on page 26 earlier in this manual.

Understanding Profiles

Any device used to control the BrightEye NXT Router must be assigned a Profile.

A Profile provides a configured view of the sources and destinations in the router. It determines which sources and destinations are accessible by the device. It also defines the order of the sources and destinations as seen by the controlling device. This ordering feature is of particular interest for automation control because it provides a simple means to map sources and destinations to suit the automation system's requirements.

An example will help illustrate how a Profile is used to connect an automation system to the router.

Note: It is important to be familiar with the methods for configuring input and output ports in the BrightEye NXT Router. For help with these topics, please refer to ["Configuring the Router's Ports"](#) on page 34.

Assume that we have cabled up the router so that it has 4 inputs and 2 outputs. Table 1 lists the inputs and outputs connected to the router in this example.

Table 1

Router port number	Src/Dest Name
Input Port 1	Network Feed
Input Port 2	Studio 3
Input Port 3	Server 6
Input Port 4	Server 4
Output Port 1	Microwave
Output Port 2	Transmitter

Suppose we want to access these inputs and outputs from an automation system and that we want to renumber the sources and destinations to fit the automation system's numbering scheme. In Table 2 we have added a column to list the desired automation number associated with each input/output.

Table 2

Router port number	Src/Dest Name	Desired automation number
Input Port 1	Network Feed	source # 7
Input Port 2	Studio 3	source # 5
Input Port 3	Server 6	source # 2
Input Port 4	Server 4	source # 3
Output Port 1	Microwave	destination # 8
Output Port 2	Transmitter	destination # 3

By rearranging the information in Table 2, we have produced a sorted list of sources and a sorted list of destinations for the automation system. The results are in Table 3 and Table 4 on the next page.

Table 3

Desired automation Src number	Src Name	Router port number
1	-	-
2	Server 6	Input Port 3
3	Server 4	Input Port 4
4	-	-
5	Studio 3	Input Port 2
6	-	-
7	Network Feed	Input Port 1

Table 4

Desired automation Dest number	Dest name	Router port number
1	-	-
2	-	-
3	Transmitter	Output Port 2
4	-	-
5	-	-
6	-	-
7	-	-
8	Microwave	Output Port 1

Note: In this example, we are assuming a protocol that numbers sources and destinations beginning with the number 1. Some protocols begin numbering at zero (e.g., the Grass Valley TEN-XL ASCII Protocol and the Generic ASCII protocol).

We can now use these lists to create a Profile in the BrightEye NXT Router that numbers the sources and destinations to match the desired automation numbering scheme.

Using the BrightEye NXT's Profile Editor to arrange the order of the sources and destinations in their respective columns, and inserting spaces at the appropriate places, we can create a Profile with the numbering order that the automation system requires. The Profile to accomplish this is illustrated in Figure 1.

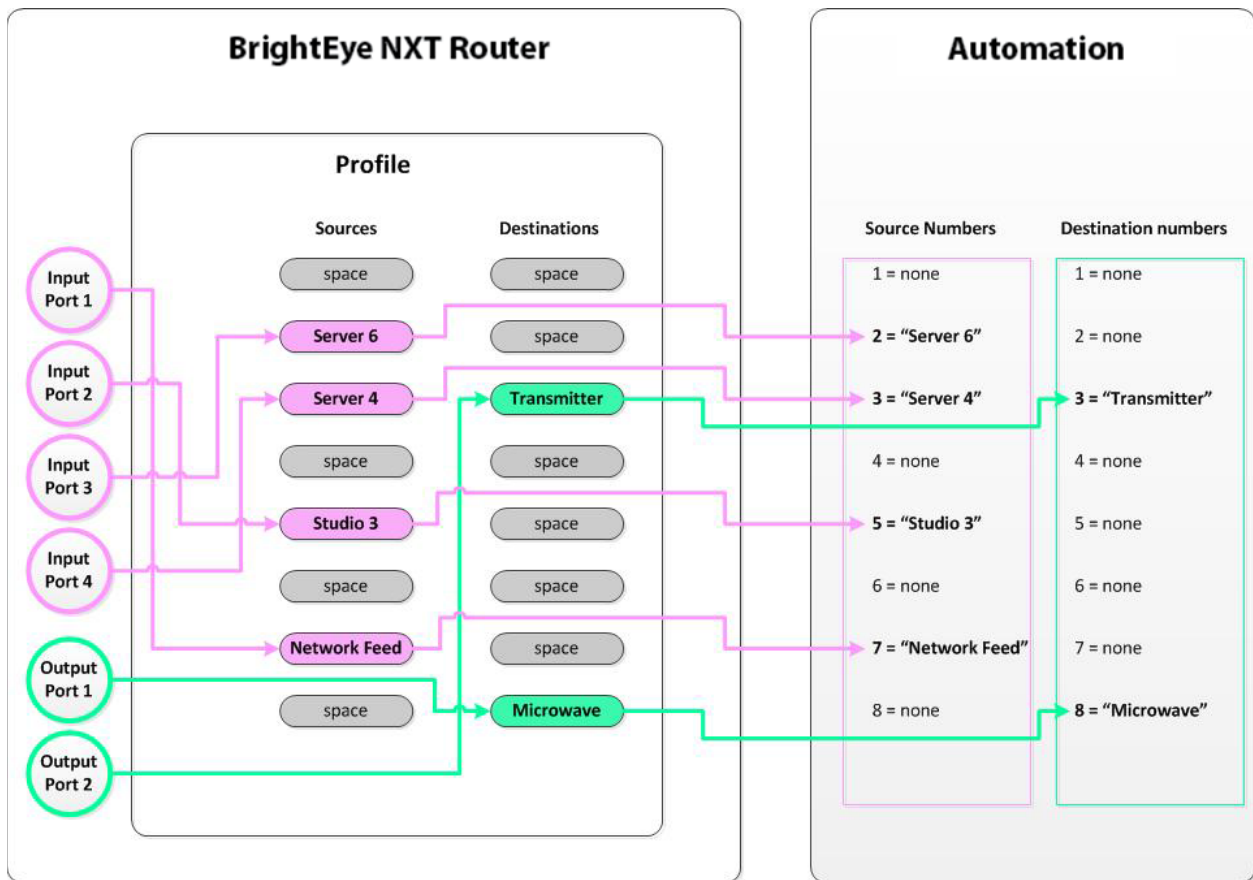

Figure 1

To change the number for a particular source or destination, simply edit the Profile and move the source or destination to its new position until the order produces the numbering scheme required by the automation system. For example, if Transmitter needs to be changed to destination 1, simply drag it to the top of the destination list in the Profile Editor and save the Profile.

For detailed instructions on how to create and edit Profiles, refer to ["Creating and Editing Profiles"](#) on page 71.

Configuration

To control the router from an external device such as an automation system, the router requires some configuration. To do this you will need to browse to the BrightEye NXT's web page from a computer. (Details for doing this are covered in ["Setting Up a Web Control Point \(Optional\)"](#) on page 62.)

After browsing to the BrightEye NXT's web page, click the gray button in the upper left part of the browser window to select **System Settings**. The **General** page will appear on the right side of the screen.

On the left side of the screen is the Navigation Panel. It is currently set to the **General** page. Use the Navigation Panel to select different areas of configuration.

Profile Configuration

To access the Profile Editor, select **Profiles** in the Navigation Panel.

Create or edit a Profile so the sources and destinations are in the order the automation system requires. Refer to the example discussed in [“Understanding Profiles”](#) on page 97.

Note: The only sources and destinations that show up in the Profile Editor are those that have been previously defined in the **Ports** page. To view this page, select **Ports** in the Navigation Panel. Refer to [“Port Configuration”](#) on page 31 for information on defining ports.

External Control Configuration

In order to control the BrightEye NXT Router from an automation system or other external controller, specific configuration choices need to be made in the External Control Editor.

To access the External Control Editor, select **External Control** in the Navigation Panel. The **External Control** page displays.

Enable TCP/IP Control

To use TCP/IP with your automation system, select **On** from the **Enable** drop-down control.

When using TCP/IP, the automation system will need to connect to Port 5200 at the BrightEye NXT Router’s IP address.

Protocol Selection

From the **Protocol** drop-down control, select which protocol the router and automation system will use to communicate. The details of the various protocols are discussed in [“Protocols”](#) on page 101.

Profile Selection

From the **Profile** drop-down control, select the Profile that will determine the automation numbering scheme. (If you have not set up a Profile, refer to [“Understanding Profiles”](#) on page 97.)

Protocols

The BrightEye NXT Router supports multiple protocols to allow crosspoint switching from external controllers.

The supported protocols are these:

- GV TEN-XL ASCII Protocol
- GV Performer ASCII Protocol
- Generic ASCII Protocol

For installations that already support one of these protocols, choosing the same protocol can minimize programming changes to the automation system when installing the BrightEye NXT Router.

These protocols are presented in the subsections below.

GV TEN-XL ASCII Protocol

The Grass Valley TEN-XL ASCII Protocol is a serial protocol used by TEN-XL Routing Switchers. For installations that already support this protocol, this is a good choice to minimize programming changes to the automation system.

The implementation of this protocol has been adapted as appropriate to reflect the features in the BrightEye NXT Router.

Protocol Requirements

- Sources and destinations are numbered starting at 0.
- All commands begin with the ASCII STX character (02H).
- Receipt of STX in the middle of a command discards all collected bytes and begins a new command.
- Errors of any kind (e.g., missing parameters, unexpected characters, out of range values, etc.) result in discarding the current command.
- Parsing will not tolerate any additional characters within a command. For example, spaces embedded within a command will cause the command to be discarded.
- Audio crosspoints are ignored on switching requests. In the Command Response message, the audio source is always reported as '0' (30H).
- The Power Supply status returned in the Command Response message is always reported as '3' (33H), which means okay.
- The protocol requires 2 digits to specify a destination. This 2-digit number represents a decimal number. For example, a destination that is specified with a high digit of '1' and a low digit of '2' represents the decimal number 12.

Commands

This section lists the commands supported in the TEN-XL ASCII protocol.

Status Request Command

Description: This command requests the current source selected on the specified destination.

Syntax: <STX><Dest High><Dest Low><ENQ>

<STX>	Start character (02H)
<Dest High>	High byte of destination number. Valid range is '0' to '9' (30H to 39H)
<Dest Low>	Low byte of destination number. Valid range is '0' to '9' (30H to 39H)
<ENQ>	Enquiry character (05H)

Example: Request the status for destination number 13. Assume that the video source assigned to this destination is 7.

Request: In Hex 02 31 33 05
 In ASCII <STX>13<ENQ>

Response: In Hex 37 30 33
 In ASCII 703

Crosspoint Select Command

Description: This command requests switching the specified video source to the specified destination. Note that the audio crosspoint specified will have no effect; however, it must be a legal ASCII decimal digit from 0 to 9.

Syntax: <STX><Dest High><Dest Low><Video Src><Audio Src>

<STX>	Start character (02H)
<Dest High>	High byte of destination number. Valid range is '0' to '9' (30H to 39H)
<Dest Low>	Low byte of destination number. Valid range is '0' to '9' (30H to 39H)
<Video Src>	Video source number. Valid range is '0' to '9' (30H to 39H)
<Audio Src>	Audio source number. Valid range is '0' to '9' (30H to 39H)

Example: Request switching video source 4 to destination 0. In this example, we specify an arbitrary audio source number of 9 which will be ignored.

Request:

In Hex	02 30 30 34 39
In ASCII	<STX>0049

Response:

In Hex	34 30 33
In ASCII	403

Notes: If the video source requested is not valid for the specified destination, the response will return the current video source that is assigned to that destination.

If the destination number specified is invalid, the command is invalid and there is no response.

Command Response Message

Description: This is the response to all valid GV TEN-XL commands sent to the router.

Syntax: <Video Src><Audio Src><PS OK>

<Video Src>	Video source number assigned to requested destination. Valid range is '0' to '9' (30H to 39H).
<Audio Src>	Audio source number. Not used. Always reported as '0' (30H).
<PS OK>	Power supply okay. Not used. Always reported as okay: '3' (33H).

Example: Router receives a Status Request command for destination number 1. Assume that video source 6 is assigned to this destination.

Request: In Hex 02 30 31 05
In ASCII <STX>01<ENQ>

Response: In Hex 36 30 33
In ASCII 603

Notes: The Audio Source number and the Power Supply portions of the response are required by the protocol, but the values returned are to be ignored.

GV Performer ASCII Protocol

The Grass Valley Performer ASCII protocol is a serial protocol used by the Performer™ 10 x 1 Routing Switcher. For installations that already support this protocol, this is a good choice to minimize programming changes to the automation system.

The implementation of this protocol has been adapted as appropriate to reflect the features in the BrightEye NXT Router.

Protocol Requirements

- Sources and destinations are numbered starting at 1.
- The BrightEye NXT Router supports source and destination numbers beyond the limit specified in the original protocol. However, any valid source or destination in the BrightEye NXT Router can be specified in this implementation of the protocol.
- The maximum byte count for Cmd Data is 251 bytes (FBH).
- Multiple commands may be sent within a single message.
- All digits in messages are ASCII hex digits. For example, a message length specified with a high digit of '1' and a low digit of '2' represents the hexadecimal number 12H, or decimal 18.
- ASCII hex digits are not case specific. The BrightEye NXT Router will accept upper or lower case ASCII hex digits.
- All messages begin with a carriage return character (0DH).
- All line feeds (0AH), spaces (20H), and nulls (00H) are ignored within messages, and are not included in the message length calculation.
- The Performer Switch 1 Address bytes in messages are ignored; however, they must be legal ASCII hex digits from '0' to 'F'.
- Errors of any kind (e.g., missing parameters, unexpected characters, out of range values, etc.) result in discarding the remaining portion of the message at the point of the error.
- The P, C, R, and Q commands are not supported and will be ignored.
- No response is sent from the BrightEye NXT Router because none of the supported commands require a response.

Message Structure

This section describes the message structure supported in the GV Performer ASCII Protocol.

A message consists of a Message Header followed by Command Data (Cmd Data). The Message Header consists of 5 bytes of information (described below). The Command Data portion can vary in size depending on which commands and how many commands are included within it.

The general message structure is as follows:

Syntax: <CR><Adr High><Adr Low><Len High><Len Low><Cmd Data>

<CR>	Carriage return (0DH). Part of the Message Header.
<Adr High>	High byte of Performer Switch 1 Address. Part of the Message Header. This is ignored, but must be valid ASCII hex digit. (E.g. '0' to '9' or 'A' to 'F').
<Adr Low>	Low byte of Performer Switch 1 Address. Part of the Message Header. This is ignored, but must be valid ASCII hex digit. (E.g. '0' to '9' or 'A' to 'F').
<Len High>	High byte of byte count for Cmd Data. Part of the Message Header. Must be valid ASCII hex digit. (E.g. '0' to '9' or 'A' to 'F').
<Len Low>	Low byte of byte count for Cmd Data. Part of the Message Header. Must be valid ASCII hex digit. (E.g. '0' to '9' or 'A' to 'F').
<Cmd Data>	Zero or more commands consisting of valid ASCII characters.

Commands

This section describes the commands in the GV Performer ASCII Protocol that are supported by the BrightEye NXT Router. Commands in the original protocol that are not supported by the BrightEye NXT Router will simply be ignored.

The commands described here fit into the <Cmd Data> field of the message described in "Message Structure" above on this page.

Note that multiple commands may be sent in a single message up to a maximum of 251 bytes.

Data Preset Command

Description: This command presets a crosspoint for later execution. The source is not actually switched to the destination until a subsequent **Take** command or **All Take** command is received by the router.

Syntax:

Message Header:

<CR><Adr High><Adr Low><Len High><Len Low>

Cmd Data:

D<Lvl High><Lvl Low><Src High><Src Low><Dest High><Dest Low>

D	ASCII character 'D' identifies this as Data Preset command.
<Lvl High>	High byte of Level. See note below.
<Lvl Low>	Low byte of Level. See note below.
<Src High>	High byte of Source number. Any valid ASCII hex digit. (E.g. '0' to '9' or 'A' to 'F').
<Src Low>	Low byte of Source number. Any valid ASCII hex digit. (E.g. '0' to '9' or 'A' to 'F').
<Dest High>	High byte of Destination number. Any valid ASCII hex digit. (E.g. '0' to '9' or 'A' to 'F').
<Dest Low>	Low byte of Destination number. Any valid ASCII hex digit. (E.g. '0' to '9' or 'A' to 'F').

Note: The only Levels supported by the BrightEye NXT Router are "All Levels" ("00" or 3030H) and "Video Level" ("01" or 3031H). These 2 Level values are treated by the router as equivalent to one another. Any other Level value will cause the command to be ignored.

Example: Request a preset of Source 14 (0EH) on Destination 2.
The Address bytes are ignored, so the example specifies an arbitrary value of "00" (3030H). For the Level bytes, the example specifies "01" (3031H). There are 7 bytes of Cmd Data in this example (specified as "07" or 3037H).

Request:

In Hex	0D 30 30 30 37 44 30 31 30 45 30 32
In ASCII	<CR> 00 07 D 01 0E 02 (spaces for readability only)

Response: No serial response. The router remembers the preset source for the specified destination.

Take Command

Description: This command requests a Take of a previously set preset source to the specified destination.

Syntax:

Message Header:

<CR><Adr High><Adr Low><Len High><Len Low>

Cmd Data:

T<Dest High><Dest Low>

T	ASCII character 'T' identifies this as Take cmd.
<Dest High>	High byte of Destination number. Any valid ASCII hex digit. (E.g. '0' to '9' or 'A' to 'F').
<Dest Low>	Low byte of Destination number. Any valid ASCII hex digit. (E.g. '0' to '9' or 'A' to 'F').

Example: Request a Take of the previous set preset source to Destination 4.

Request:

In Hex	0D 30 30 30 33 54 30 34
In ASCII	<CR> 00 03 T 04 (spaces for readability only)

Response: No serial response. If a preset source had previously been set for Destination 4, the router now switches that source to Destination 4.

All Take Command

Description: This command requests a Take of all previously set preset sources to their respective destinations.

Syntax:

Message Header:

<CR><Adr High><Adr Low><Len High><Len Low>

Cmd Data:

A

A	ASCII character 'A' identifies this as All Take command.
---	--

Example: Request a Take of all the previously set preset sources to their respective destinations.

Request: In Hex 0D 30 30 30 31 41
In ASCII <CR> 00 01 A (spaces for readability only)

Response: No serial response. All preset sources are switched to their respective destinations.

Generic ASCII Protocol

The Generic ASCII protocol is based on the Leitch Pass-Through Protocol described in Chapter 4 of the Leitch serial protocol reference manual "SPR-MAN", edition 4.

The Generic ASCII protocol supports a subset of the commands described in the Leitch protocol. Commands described in the Leitch protocol that are unsupported by the BrightEye NXT Router are simply ignored.

The implementation of this protocol has been adapted as appropriate to reflect the features in the BrightEye NXT Router.

Protocol Requirements

- Sources and destinations are numbered starting at 0.
- Commands must be sent one at a time. Before sending the next command, wait for the router to send the prompt ('>').
- Errors of any kind (e.g., missing parameter, unexpected characters, out of range values, etc.) result in discarding the current command. There is no error reporting.
- Parsing will not tolerate any additional characters within a command. For example, spaces embedded within a command will cause the command to be discarded.
- All digits in messages are ASCII hex digits. For example, a source specified with a high digit of '1' and a low digit of '2' represents the hexadecimal number 12H, or decimal 18.
- ASCII hex digits are not case specific. The BrightEye NXT Router will accept upper or lower case ASCII hex digits. Responses from the BrightEye NXT Router will always use lower case for ASCII hex digits.
- Sources and destinations can be specified using up to 4 ASCII digit characters. E.g., Source 2 can be specified as "2", "02", "002", or "0002".
- The BrightEye NXT Router does not support multiple levels as described in the Pass-Through Protocol. In commands that specify a level number, the BrightEye NXT Router will only respond to level 0. All other level designations are ignored. Levels are specified in a single hex digit from '0' to 'F'.

Router Responses

All commands sent to the BrightEye NXT Router must be terminated with a carriage return character (ODH). Upon receiving a carriage return, the BrightEye NXT Router will send a response to the automation system.

The possible responses are a simple **Prompt Response** or a **Status Response** followed by a **Prompt Response**. These are discussed below.

Prompt Response

This response consists of the single ASCII character '>' (3EH).

The BrightEye NXT Router will send this response anytime it receives a carriage return. This is an indication to the automation system that the router is ready for the next command.

If a command is sent to the BrightEye NXT Router that requires a more extensive response, the **Prompt Response** will be sent immediately following the more extensive response.

Status Response

Certain commands sent to the BrightEye NXT Router require that a **Status Response** be returned by the router. This response identifies the source that is currently switched to the destination specified. The response takes this form:

Syntax: S:<Lvl><Dest>,<Src><CR><LF>

S:	ASCII character 'S' (53H) followed by ASCII character ':' (3AH). Identifies this as a Status Response.
<Lvl>	This is the level. The BrightEye NXT Router will always report this to 0.
<Dest>	Destination number. No leading zeros will be used. Any valid ASCII hex digits. (E.g. '0' to '9' or 'A' to 'F').
,	Comma character (2CH). Separates destination numbers from source numbers.
<Src>	Source number. No leading zeros will be used. Any valid ASCII hex digits. (E.g. '0' to '9' or 'A' to 'F').
<CR>	ASCII carriage return character (0DH).
<LF>	ASCII line feed character (0AH).

Example: In response to a **Direct Crosspoint Take** command, suppose that the BrightEye NXT Router reports that Source 11 (0BH) is selected on Destination 4. The response would look as follows. (Note that the router will always report the Level as 0):

Response: In Hex 53 3A 30 34 2C 62 0D 0A
 In ASCII S:04,b<CR><LF>

Note: After the **Status Response** is sent, a **Prompt Response** is sent.

Commands

This section lists the commands supported in the Generic ASCII protocol.

Commands from the original Leitch Pass-Through Protocol that are not listed in this section are not supported by the BrightEye NXT router and will be ignored.

Direct Crosspoint Take Command

Description: This command requests a Take operation on the specified destination-source pair(s).

Syntax: @<Space>X:<Lvls>/<Dest>,<Src>[/<Dest>,<Src>...]<CR>

@<Space>	ASCII '@' (40H) followed by ASCII space character ' ' (20H). Identifies the start of a command.
X:	ASCII 'X' followed by ASCII ':'. Identifies this as a Direct Crosspoint Take command.
<Lvls>	The level(s) to be affected. Multiple levels may be specified by listing several digits in a row. The BrightEye NXT Router only supports level 0 and ignores other levels. A level is specified by a single valid ASCII hex digit. (E.g. '0' to '9' or 'A' to 'F').
/	ASCII forward slash character '/' (2FH). Separates Levels from destination-source pairs. Forward slash is also used to separate multiple destination-source pairs when more than one pair is specified.
<Dest>	Destination number. Up to 4 characters (including leading zeros) may be used to specify the destination. Any valid ASCII hex digits. (E.g. '0' to '9' or 'A' to 'F').
,	Comma character (2CH). Separates destination numbers from source numbers in each destination-source pair.
<Src>	Source number. Up to 4 characters (including leading zeros) may be used to specify the source. Any valid ASCII hex digits. (E.g. '0' to '9' or 'A' to 'F').
<CR>	ASCII carriage return character (0DH).

Example 1: Perform a Take of Source 10 (0AH) on Destination 4. Level 0 must be specified.

Request: In Hex 40 20 58 3A 30 2F 34 2C 41 0D
In ASCII @ X:0/4,A<CR>

Response: In Hex 53 3A 30 34 2C 61 0D 0A
In ASCII S:04,a<CR><LF>

Example 2: Perform a Take of sources on multiple destinations: Source 9 on Destination 3, Source 7 on Destination 1, and Source 5 on Destination 2.

Request: In Hex 40 20 58 3A 30 2F 33 2C 39 2F 31 2C 37 2F 32 2C 35 0D
In ASCII @ X:0/3,9/1,7/2,5<CR>

Response: In Hex 53 3A 30 33 2C 39 0D 0A
 53 3A 30 31 2C 37 0D 0A
 53 3A 30 32 2C 35 0D 0A

 In ASCII S:03,9<CR><LF>
 S:01,7<CR><LF>
 S:02,5<CR><LF>

Crosspoint Status Command

Description: This command requests the crosspoint status of the specified destination.

Syntax: @<Space>X?<Lvl><Dest><CR>

@<Space>	ASCII '@' (40H) followed by ASCII space character ' ' (20H). Identifies the start of a command.
X?	ASCII 'X' followed by ASCII '?'. Identifies this as a Crosspoint Status command.
<Lvl>	The BrightEye NXT Router only supports level 0. Must be ASCII digit '0'.
<Dest>	Destination number. Up to 4 characters (including leading zeros) may be used to specify the destination. Any valid ASCII hex digits. (E.g. '0' to '9' or 'A' to 'F').
<CR>	ASCII carriage return character (0DH).

Example: Get the status of Destination 7. Level 0 must be specified. Assume that the router reports Source 6 is selected on Destination 7.

Request: In Hex 40 20 58 3F 30 37 0D
 In ASCII @ X?07<CR>

Response: In Hex 53 3A 30 37 2C 36 0D 0A
 In ASCII S:07,6<CR><LF>

Preset Crosspoint Command

Description: This command stores crosspoints in the preset buffer for later execution. The preset destination-source pairs are not actually switched until a subsequent Execute Preset Buffer command is issued.

Syntax: @<Space>P:<Lvls>/<Dest>,<Src>[/<Dest>,<Src>...]<CR>

@<Space>	ASCII '@' (40H) followed by ASCII space character ' ' (20H). Identifies the start of a command.
P:	ASCII 'P' followed by ASCII ':' (3AH). Identifies this as a Preset Crosspoint command.
<Lvls>	The level(s) to be affected. Multiple levels may be specified by listing several digits in a row. The BrightEye NXT Router only supports level 0 and ignores other levels. A level is specified by a single valid ASCII hex digit. (E.g. '0' to '9' or 'A' to 'F').
/	ASCII forward slash character '/' (2FH). Separates Levels from destination-source pairs. Forward slash is also used to separate multiple destination-source pairs when more than one pair is specified.
<Dest>	Destination number. Up to 4 characters (including leading zeros) may be used to specify the destination. Any valid ASCII hex digits. (E.g. '0' to '9' or 'A' to 'F').
,	Comma character (2CH). Separates destination numbers from source numbers in each destination-source pair.
<Src>	Source number. Up to 4 characters (including leading zeros) may be used to specify the source. Any valid ASCII hex digits. (E.g. '0' to '9' or 'A' to 'F').
<CR>	ASCII carriage return character (0DH).

Example 1: Perform a preset of Source 10 (0AH) on Destination 4. Level 0 must be specified.

Request:

In Hex	40 20 50 3A 30 2F 34 2C 41 0D
In ASCII	@ P:0/4,A<CR>

Response:

In Hex	3E
In ASCII	'>'

Example 2: Perform presets of the following source-destination pairs: Source 9 on Destination 3, Source 7 on Destination 1, and Source 5 on Destination 2.

Request:

In Hex	40 20 50 3A 30 2F 33 2C 39 2F 31 2C 37 2F 32 2C 35 0D
In ASCII	@ P:0/3,9/1,7/2,5<CR>

Response:

In Hex	3E
In ASCII	'>'

Execute Preset Buffer Command

Description: This command executes a Take operation on all crosspoints previously stored in the preset buffer.

Syntax: @<Space>B:E<CR>

@<Space>	ASCII '@' (40H) followed by ASCII space character ' ' (20H). Identifies the start of a command.
B:	ASCII 'B' followed by ASCII ':' (3AH). Identifies this as one of the "buffer" commands.
E	ASCII 'E'. Identifies this as the Execute Preset Buffer command.
<CR>	ASCII carriage return character (0DH).

Example: Execute the crosspoints previously stored in the preset buffer. Assume the presets are as follows: Source 9 on Destination 3, Source 7 on Destination 1, and Source 5 on Destination 2.

Request:

In Hex	40 20 42 3A 45 0D
In ASCII	@ B:E<CR>

Response:

In Hex	53 3A 30 33 2C 39 0D 0A 53 3A 30 31 2C 37 0D 0A 53 3A 30 32 2C 35 0D 0A
In ASCII	S:03,9<CR><LF> S:01,7<CR><LF> S:02,5<CR><LF>

Clear Preset Buffer Command

Description: This command clears all crosspoints in the preset buffer.

Syntax: @<Space>B:C<CR>

@<Space>	ASCII '@' (40H) followed by ASCII space character ' ' (20H). Identifies the start of a command.
B:	ASCII 'B' followed by ASCII ':' (3AH). Identifies this as one of the "buffer" commands.
C	ASCII 'C' Identifies this as the Clear Preset Buffer command.
<CR>	ASCII carriage return character (0DH).

Example: Clear the crosspoints previously stored in the preset buffer.

Request: In Hex 40 20 42 3A 43 0D
In ASCII @ B:C<CR>

Response: In Hex 3E
In ASCII '>'

Chapter 7: Maintenance and Troubleshooting

This chapter addresses issues that new users may encounter while becoming familiar with the BrightEye NXT Compact Router.

Switching Signals Does Not Occur Smoothly

If you are using a model 410 or 430, make sure you have properly assigned one of the two Clean Switches to the Output Port. When correctly assigned, the Clean Switched output will always switch cleanly.

Please see [About Clean Switches and Clean Switch Configuration](#) on page 40.

Cannot Connect to the BrightEye NXT from a Web Browser

If you are having difficulty connecting to the BrightEye NXT Router from a web browser, check that the IP addresses of the Router and the computer or device are not in conflict. Check also that the cabling is correct.

- Please see [Setting Up a Web Control Point \(Optional\)](#) on page 62.
- See also [Establishing Additional Control Points and Access Authentication](#) on page 68.

In some instances, if you are using the subnet mask of 255.255.255.0, try using 255.255.0.0 instead.

If you are still having issues, power off your BrightEye NXT unit. Make sure that you have connected the Ethernet cable to the Ethernet port on the back of the BrightEye NXT unit. Power the BrightEye NXT unit back on. It is best to have the Ethernet cable connected before powering on the BrightEye NXT unit.

Supported Browsers

The Router supports current versions of the following browsers for Mac and PC:

- Safari (version 5 or later)
- Firefox (version 12 or later)
- Chrome (version 17 or later)
- Internet Explorer (version 9 or later)

Enabling cookies is required for all browsers.

The Take Button is Grayed Out

If the **Take** button is blue, it means that a Take is possible. If the **Take** button is grayed out, then no Take can be done without first selecting both a Source and a Destination. If a Source and a Destination you want are already selected, you do not need to select one again.

Resetting to Factory Default Settings

If you need to reset your BrightEye NXT unit back to the factory default settings:

1. Power off your BrightEye NXT unit.
2. Immediately after powering it on again, during the boot up process, press and hold both the OK button and the Configuration button (gear icon) until the up, down, left and right arrow buttons blink red several times.
3. After the boot up process is complete, the unit will be reset to factory default settings.

Software Updating

1. Download the latest software version to your computer. Software upgrades for the BrightEye NXT routers are available free at the following link:

www.ensembledesigns.com/support/brighteye-support/

2. A web browser connection is required in order to update the software. Please refer to [Setting Up a Web Control Point \(Optional\)](#) on page 62.

Once you are able to connect to the BrightEye NXT through a web browser, you can proceed with the next steps.

3. From the web browser, navigate to the BrightEye NXT's IP address. The router control page displays.
4. From the upper left area of the browser window, select Settings from the drop-down menu. The BrightEye NXT Settings > General page displays.
5. From the Settings > General page, under the heading "Software Update," select the "Choose File" button. Navigate to the software you downloaded in step 1 from the Ensemble Designs web site.
6. Select Update Software. The update process may take several minutes.

Warranty and Factory Service

Warranty

This unit is covered by a five year limited warranty. If you require service (under warranty or not), please contact Ensemble Designs and ask for customer service before you return the unit. This will allow the service technician to provide any other suggestions for identifying the problem and recommending possible solutions.

Factory Service

If you return equipment for repair, please get a Return Material Authorization Number (RMA) from the factory first.

tel +1 530.478.1830

fax +1 530.478.1832

service@ensembledesigns.com

www.ensembledesigns.com

Ship the product and a written description of the problem to:

Ensemble Designs, Inc.
Attention: Customer Service RMA #####
870 Gold Flat Rd.
Nevada City, CA 95959 USA

Be sure to put your RMA number on the outside of the box.

Specifications

For BrightEye NXT 410 Clean HDMI Router

Serial Digital Input

Number	Two to Five, configurable, BNC and SFP
Signal Type	270 Mb/s SD SDI, SMPTE 259M 1.485 Gb/s HD SDI, SMPTE 274M, 292M, 296M 2.97 Gb/s HD SDI, SMPTE 424M, 425M
Impedance	75 Ω
Return Loss	>15 dB
Max Cable Length	300 meters for 270 Mb/s 100 meters for 1.485 Gb/s

Automatic Input Cable Equalization

Reference Input

Number	One
Signal Type	1 V P-P Composite Video, PAL or NTSC or Tri-Level Sync
Impedance	75 Ω
Return Loss	>40 dB

Serial Digital Output

Number	Two to Five, configurable, BNC and SFP
Signal Type	270 Mb/s SD SDI, SMPTE 259M 1.485 Gb/s HD SDI, SMPTE 274M, 292M, 296M 2.97 Gb/s HD SDI, SMPTE 424M, 425M
Processing	12 and 16 bit
Impedance	75 Ω
Return Loss	>15 dB
Max Cable Length	100 meters for HD 300 meters for SD (Belden 1694A)

HDMI Input

Number	Four
Signal Type	HDMI 1.3
Format	Supports HDMI signals which map to the video standards listed below

HDMI Output

Number	One
Signal Type	HDMI 1.3
Format	Follows input

Standards Supported

1080i 50, 59.94 or 60 Hz, SMPTE 274M -4,5,6
720p 50, 59.94 or 60 Hz, SMPTE 296M -1,2,3
1080p 23.98, 24 or 25 Hz, SMPTE 274M -9,10,11
1080p 50, 59.94, 60 Hz, SMPTE 424M, 425M, Level A
1080sF 23.98, 24 or 25 Hz, RP211 -14,15,16
625i 50
525i 59.94

General Specifications

Size	5.63" W x 1.65" H x 6.75" D (143 mm x 42 mm x 172 mm) including connectors and flange
Weight	1 lb 12 oz
Power	12 volts, 20 watts (100-230 VAC modular power supply)
Temperature Range	0 to 40° C ambient (all specs met)
Relative Humidity	0 to 95%, non-condensing
Altitude	0 to 10,000 ft.

For BrightEye NXT 415 and 430 Compact Routers

Serial Digital Input

Number	Two to Thirteen, configurable, BNC and SFP
Signal Type	270 Mb/s SD SDI, SMPTE 259M 1.485 Gb/s HD SDI, SMPTE 274M, 292M, 296M 2.97 Gb/s HD SDI, SMPTE 424M, 425M
Impedance	75 Ω
Return Loss	>15 dB
Max Cable Length	300 meters for 270 Mb/s 100 meters for 1.485 Gb/s

Automatic Input Cable Equalization

Reference Input

Number	One
Signal Type	1 V P-P Composite Video, PAL or NTSC or Tri-Level Sync
Impedance	75 Ω
Return Loss	>40 dB

Serial Digital Output

Number	Two to Thirteen, configurable, BNC and SFP
Signal Type	270 Mb/s SD SDI, SMPTE 259M 1.485 Gb/s HD SDI, SMPTE 274M, 292M, 296M 2.97 Gb/s HD SDI, SMPTE 424M, 425M
Processing	12 and 16 bit
Impedance	75 Ω
Return Loss	>15 dB
Max Cable Length	100 meters for HD (Belden 1694A) 300 meters for SD (Belden 1694A)

Standards Supported

1080i 50, 59.94 or 60 Hz, SMPTE 274M -4,5,6
720p 50, 59.94 or 60 Hz, SMPTE 296M -1,2,3
1080p 23.98, 24 or 25 Hz, SMPTE 274M -9,10,11
1080p 50, 59.94, 60 Hz, SMPTE 424M, 425M, Level A
1080sF 23.98, 24 or 25 Hz, RP211 -14,15,16
625i 50
525i 59.94

General Specifications

Size	5.63" W x 1.65" H x 6.75" D (143 mm x 42 mm x 172 mm) including connectors and flange
Weight	NXT 415 1 lb 10 oz NXT 430 1 lb 12 oz
Power	12 volts, 20 watts (100-230 VAC modular power supply)
Temperature Range	0 to 40° C ambient (all specs met)
Relative Humidity	0 to 95%, non-condensing
Altitude	0 to 10,000 ft.

Glossary

AES/EBU

The digital audio standard defined as a joint effort of the Audio Engineering Society and the European Broadcast Union. AES/EBU or AES3 describes a serial bitstream that carries two audio channels, thus an AES stream is a stereo pair. The AES/EBU standard covers a wide range of sample rates and quantizations (bit depths). In television systems, these will generally be 48 KHz and either 20 or 24 bits.

AFD

Active Format Description is a method to carry information regarding the aspect ratio of the video content. The specification of AFD was standardized by SMPTE in 2007 and is now beginning to appear in the marketplace. AFD can be included in both SD and HD SDI transport systems. There is no legacy analog implementation. (See WSS).

ASI

A commonly used transport method for MPEG video streams, ASI or Asynchronous Serial Interface, operates at the same 270 Mb/s data rate as SD SDI. This makes it easy to carry an ASI stream through existing digital television infrastructure. Known more formally as DVB-ASI, this transport mechanism can be used to carry multiple program channels.

Aspect Ratio

The ratio of the vertical and horizontal measurements of an image. 4:3 is the aspect ratio for standard definition video formats and television and 16:9 for high definition. Converting formats of unequal ratios is done by letterboxing (horizontal bars) or pillar boxing (vertical pillars) in order to keep the original format's aspect ratio.

Bandwidth

Strictly speaking, this refers to the range of frequencies (i.e. the width of the band of frequency) used by a signal, or carried by a transmission channel. Generally, wider bandwidth will carry and reproduce a signal with greater fidelity and accuracy.

Beta

Sony Beta SP video tape machines use an analog component format that is similar to SMPTE, but differs in the amplitude of the color difference signals. It may also carry setup on the luminance channel.

Bit

A binary digit, or bit, is the smallest amount of information that can be stored or transmitted digitally by electrical, optical, magnetic, or other means. A single bit can take on one of two states: On/Off, Low/High, Asserted/ Deasserted, etc. It is represented numerically by the numerals 1 (one) and 0 (zero). A byte, containing 8 bits, can represent 256 different states. The binary number 11010111, for example, has the value of 215 in our base 10 numbering system. When a value is carried digitally, each

additional bit of resolution will double the number of different states that can be represented. Systems that operate with a greater number of bits of resolution, or quantization, will be able to capture a signal with more detail or fidelity. Thus, a video digitizer with 12 bits of resolution will capture 4 times as much detail as one with 10 bits.

Blanking

The Horizontal and Vertical blanking intervals of a television signal refer to the time periods between lines and between fields. No picture information is transmitted during these times, which are required in CRT displays to allow the electron beam to be repositioned for the start of the next line or field. They are also used to carry synchronizing pulses which are used in transmission and recovery of the image. Although some of these needs are disappearing, the intervals themselves are retained for compatibility purposes. They have turned out to be very useful for the transmission of additional content, such as teletext and embedded audio.

CAV

Component Analog Video. This is a convenient shorthand form, but it is subject to confusion. It is sometimes used to mean ONLY color difference component formats (SMPTE or Beta), and other times to include RGB format. In any case, a CAV signal will always require 3 connectors – either Y/R-Y/B-Y, or R/G/B.

Checkfield

A Checkfield signal is a special test signal that stresses particular aspects of serial digital transmission. The performance of the Phase Locked-Loops (PLLs) in an SDI receiver must be able to tolerate long runs of 0's and 1's. Under normal conditions, only very short runs of these are produced due to a scrambling algorithm that is used. The Checkfield, also referred to as the Pathological test signal, will "undo" the scrambling and cause extremely long runs to occur. This test signal is very useful for testing transmission paths.

Chroma

The color or chroma content of a signal, consisting of the hue and saturation of the image. See also Color Difference.

Component

In a component video system, the totality of the image is carried by three separate but related components. This method provides the best image fidelity with the fewest artifacts, but it requires three independent transmission paths (cables). The commonly used component formats are Luminance and Color Difference (Y/Pr/Pb), and RGB. It was far too unwieldy in the early days of color television to even consider component transmission.

Composite

Composite television dates back to the early days of color transmission. This scheme encodes the color difference information onto a color subcarrier. The instantaneous phase of the subcarrier is the color's hue, and the amplitude is the color's saturation or intensity. This subcarrier is then added onto the existing luminance video signal. This trick works because the subcarrier is set at a high enough frequency to leave spectrum for the luminance information. But it is not a seamless matter to pull

the signal apart again at the destination in order to display it or process it. The resultant artifacts of dot crawl (also referred to as chroma crawl) are only the most obvious result. Composite television is the most commonly used format throughout the world, either as PAL or NTSC. It is also referred to as Encoded video.

Color Difference

Color Difference systems take advantage of the details of human vision. We have more acuity in our black and white vision than we do in color. This means that we need only the luminance information to be carried at full bandwidth, we can scrimp on the color channels. In order to do this, RGB information is converted to carry all of the luminance (Y is the black and white of the scene) in a single channel. The other two channels are used to carry the "color difference". Noted as B-Y and R-Y, these two signals describe how a particular pixel "differs" from being purely black and white. These channels typically have only half the bandwidth of the luminance.

Decibel (dB)

The decibel is a unit of measure used to express the ratio in the amplitude or power of two signals. A difference of 20 dB corresponds to a 10:1 ratio between two signals, 6 dB is approximately a 2:1 ratio. Decibels add while the ratios multiply, so 26 dB is a 20:1 ratio, and 14 dB is a 5:1 ratio. There are several special cases of the dB scale, where the reference is implied. Thus, dBm refers to power relative to 1 milliwatt, and dBu refers to voltage relative to .775V RMS. The original unit of measure was the Bel (10 times bigger), named after Alexander Graham Bell.

dBFS

In Digital Audio systems, the largest numerical value that can be represented is referred to as Full Scale. No values or audio levels greater than FS can be reproduced because they would be clipped. The nominal operating point (roughly corresponding to 0 VU) must be set below FS in order to have headroom for audio peaks. This operating point is described relative to FS, so a digital reference level of -20 dBFS has 20 dB of headroom before hitting the FS clipping point.

DVI

Digital Visual Interface. DVI-I (integrated) provides both digital and analog connectivity. The larger group of pins on the connector are digital while the four pins on the right are analog.

EDH

Error Detection and Handling is a method to verify proper reception of an SDI or HD-SDI signal at the destination. The originating device inserts a data packet in the vertical interval of the SDI signal and every line of the HD signal which contains a checksum of the entire video frame. This checksum is formed by adding up the numerical values of all of the samples in the frame, using a complex formula. At the destination this same formula is applied to the incoming video and the resulting value is compared to the one included in the transmission. If they match, then the content has all arrived with no errors. If they don't, then an error has occurred.

Embedded Audio

Digital Audio can be carried along in the same bitstream as an SDI or HD-SDI signal by taking advantage of the gaps in the transmission which correspond to the horizontal and vertical intervals

of the television waveform. This technique can be very cost effective in transmission and routing, but can also add complexity to signal handling issues because the audio content can no longer be treated independently of the video.

Eye Pattern

To analyze a digital bitstream, the signal can be displayed visually on an oscilloscope by triggering the horizontal timebase with a clock extracted from the stream. Since the bit positions in the stream form a very regular cadence, the resulting display will look like an eye – an oval with slightly pointed left and right ends. It is easy to see from this display if the eye is “open”, with a large central area that is free of negative or positive transitions, or “closed” where those transitions are encroaching toward the center. In the first case, the open eye indicates that recovery of data from the stream can be made reliably and with few errors. But in the closed case data will be difficult to extract and bit errors will occur. Generally it is jitter in the signal that is the enemy of the eye.

Frame Sync

A Frame Synchronizer is used to synchronize the timing of a video signal to coincide with a timing reference (usually a color black signal that is distributed throughout a facility). The synchronizer accomplishes this by writing the incoming video into a frame buffer memory under the timing direction of the sync information contained in that video. Simultaneously the memory is being read back by a timing system that is genlocked to a house reference. As a result, the timing or alignment of the video frame can be adjusted so that the scan of the upper left corner of the image is happening simultaneously on all sources. This is a requirement for both analog and digital systems in order to perform video effects or switch glitch-free in a router. Frame synchronization can only be performed within a single television line standard. A synchronizer will not convert an NTSC signal to a PAL signal, it takes a standards converter to do that.

Frequency Response

A measurement of the accuracy of a system to carry or reproduce a range of signal frequencies. Similar to Bandwidth.

H.264

The latest salvo in the compression wars is H.264 which is also known as MPEG-4 Part 10. MPEG-4 promises good results at just half the bit rate required by MPEG-2.

HD

High Definition. This two letter acronym has certainly become very popular. Here we thought it was all about the pictures – and the radio industry stole it.

HDMI

The High Definition Multimedia Interface comes to us from the consumer marketplace where it is becoming the de facto standard for the digital interconnect of display devices to audio and video sources. It is an uncompressed, all-digital interface that transmits digital video and eight channels of digital audio. HDMI is a bit serial interface that carries the video content in digital component form over multiple twisted-pairs. HDMI is closely related to the DVI interface for desktop computers and their displays.

IEC

The International Electrotechnical Commission provides a wide range of worldwide standards. They have provided standardization of the AC power connection to products by means of an IEC line cord. The connection point uses three flat contact blades in a triangular arrangement, set in a rectangular connector. The IEC specification does not dictate line voltage or frequency. Therefore, the user must take care to verify that a device either has a universal input (capable of 90 to 230 volts, either 50 or 60 Hz), or that a line voltage switch, if present, is set correctly.

Interlace

Human vision can be fooled to see motion by presenting a series of images, each with a small change relative to the previous image. In order to eliminate the flicker, our eyes need to see more than 30 images per second. This is accomplished in television systems by dividing the lines that make up each video frame (which run at 25 or 30 frames per second) into two fields. All of the odd-numbered lines are transmitted in the first field, the even-numbered lines are in the second field. In this way, the repetition rate is 50 or 60 Hz, without using more bandwidth. This trick has worked well for years, but it introduces other temporal artifacts. Motion pictures use a slightly different technique to raise the repetition rate from the original 24 frames that make up each second of film—they just project each one twice.

IRE

Video level is measured on the IRE scale, where 0 IRE is black, and 100 IRE is full white. The actual voltages that these levels correspond to can vary between formats.

ITU-R 601

This is the principal standard for standard definition component digital video. It defines the luminance and color difference coding system that is also referred to as 4:2:2. The standard applies to both PAL and NTSC derived signals. They both will result in an image that contains 720 pixels horizontally, with 486 vertical pixels in NTSC, and 576 vertically in PAL. Both systems use a sample clock rate of 27 MHz, and are serialized at 270 Mb/s.

Jitter

Serial digital signals (either video or audio) are subject to the effects of jitter. This refers to the instantaneous error that can occur from one bit to the next in the exact position of each digital transition. Although the signal may be at the correct frequency on average, in the interim it varies. Some bits come slightly early, others come slightly late. The measurement of this jitter is given either as the amount of time uncertainty or as the fraction of a bit width. For 270 Mb/s SD video, the allowable jitter is 740 picoseconds, or 0.2 UI (Unit Interval – one bit width). For 1.485 Gb/s HD, the same 0.2UI spec corresponds to just 135 pico seconds.

Luminance

The “black & white” content of the image. Human vision had more acuity in luminance, so television systems generally devote more bandwidth to the luminance content. In component systems, the luminance is referred to as Y.

MPEG

The Moving Picture Experts Group is an industry group that develops standards for the compression of moving pictures for television. Their work is an on-going effort. The understanding of image processing and information theory is constantly expanding. And the raw bandwidth of both the hardware and software used for this work is ever increasing. Accordingly, the compression methods available today are far superior to the algorithms that originally made the real-time compression and decompression of television possible. Today, there are many variations of these techniques, and the term MPEG has to some extent become a broad generic label.

Metadata

This word comes from the Greek, meta means 'beyond' or 'after'. When used as a prefix to 'data', it can be thought of as 'data about the data'. In other words, the metadata in a data stream tells you about that data – but it is not the data itself. In the television industry, this word is sometimes used correctly when, for example, we label as metadata the timecode which accompanies a video signal. That timecode tells you something about the video, i.e. when it was shot, but the timecode in and of itself is of no interest. But in our industry's usual slovenly way in matters linguistic, the term metadata has also come to be used to describe data that is associated with the primary video in a datastream. So embedded audio will (incorrectly) be called metadata when it tells us nothing at all about the pictures. Oh well.

Multi-mode

Multi-mode fibers have a larger diameter core than single mode fibers (either 50 or 62.5 microns compared to 9 microns), and a correspondingly larger aperture. It is much easier to couple light energy into a multi-mode fiber, but internal reflections will cause multiple "modes" of the signal to propagate down the fiber. This will degrade the ability of the fiber to be used over long distances. See also Single Mode.

NTSC

The color television encoding system used in North America was originally defined by the National Television Standards Committee. This American standard has also been adopted by Canada, Mexico, Japan, Korea, and Taiwan. (This standard is referred to disparagingly as Never Twice Same Color.)

Optical

An optical interface between two devices carries data by modulating a light source. This light source is typically a laser or laser diode (similar to an LED) which is turned on and off at the bitrate of the datastream. The light is carried from one device to another through a glass fiber. The fiber's core acts as a waveguide or lightpipe to carry the light energy from one end to another. Optical transmission has two very significant advantages over metallic copper cables. Firstly, it does not require that the two endpoint devices have any electrical connection to each other. This can be very advantageous in large facilities where problems with ground loops appear. And secondly, and most importantly, an optical interface can carry a signal for many kilometers or miles without any degradation or loss in the recovered signal. Copper is barely useful at distances of just 1000 feet.

Oversampling

A technique to perform digital sampling at a multiple of the required sample rate. This has the advantage of raising the Nyquist Rate (the maximum frequency which can be reproduced by a given sample rate) much higher than the desired passband. This allows more easily realized anti-aliasing filters.

PAL

During the early days of color television in North America, European broadcasters developed a competing system called Phase Alternation by Line. This slightly more complex system is better able to withstand the differential gain and phase errors that appear in amplifiers and transmission systems. Engineers at the BBC claim that it stands for Perfection At Last.

Pathological Test Pattern – see Checkfield

Progressive

An image scanning technique which progresses through all of the lines in a frame in a single pass. Computer monitors all use progressive displays. This contrasts to the interlace technique common to television systems.

Return Loss

An idealized input or output circuit will exactly match its desired impedance (generally 75 ohms) as a purely resistive element, with no reactive (capacitive or inductive) elements. In the real world, we can only approach the ideal. So, our real inputs and outputs will have some capacitance and inductance. This will create impedance matching errors, especially at higher frequencies. The Return Loss of an input or output measures how much energy is returned (reflected back due to the impedance mismatch). For digital circuits, a return loss of 15 dB is typical. This means that the energy returned is 15 dB less than the original signal. In analog circuits, a 40 dB figure is expected.

RGB

RGB systems carry the totality of the picture information as independent Red, Green, and Blue signals. Television is an additive color system, where all three components add to produce white. Because the luminance (or detail) information is carried partially in each of the RGB channels, all three must be carried at full bandwidth in order to faithfully reproduce an image.

ScH Phase

Used in composite systems, ScH Phase measures the relative phase between the leading edge of sync on line 1 of field 1 and a continuous subcarrier sinewave. Due to the arithmetic details of both PAL and NTSC, this relationship is not the same at the beginning of each frame. In PAL, the pattern repeats every 4 frames (8 fields) which is also known as the Bruch Blanking sequence. In NTSC, the repeat is every 2 frames (4 fields). This creates enormous headaches in editing systems and the system timing of analog composite facilities.

Setup

In the NTSC Analog Composite standard, the term Setup refers to the addition of an artificial offset or pedestal to the luminance content. This places the Black Level of the analog signal 54 mV (7.5 IRE) positive with respect to ground. The use of Setup is a legacy from the early development of television receivers in the vacuum tube era. This positive offset helped to prevent the horizontal retrace of the electron beam from being visible on the CRT, even if Brightness and Contrast were mis-adjusted. While the use of Setup did help to prevent retrace artifacts, it did so at the expense of dynamic range (contrast) in the signal because the White Level of the signal was not changed.

Setup is optional in NTSC systems, but is never used in PAL systems (see 'Perfection' characteristic of PAL). This legacy of Setup continues to persist in North American NTSC systems, while it has been abandoned in Japan.

In the digital component world (SD and HD SDI) there is obviously no need for, and certainly every reason to avoid, Setup. In order for the interfaces between analog and digital systems to operate as transparently as possible, Setup must be carefully accounted for in conversion products. When performing analog to digital conversion, Setup (if present) must be removed and the signal range gained up to account for the 7.5% reduction in dynamic range. And when a digital signal is converted back to analog form, Setup (if desired on the output) must be created by reducing the dynamic range by 7.5% and adding the 54 mV positive offset. Unfortunately, there is no truly foolproof algorithm to detect the presence of Setup automatically, so it's definitely a case of installer beware.

SDI

Serial Digital Interface. This term refers to inputs and outputs of devices that support serial digital component video. This could refer to standard definition at 270 Mb/s, HD SDI or High Definition Serial Digital video at 1.485 Gb/s, or to the newer 3G standard of High Definition video at 2.97 Gb/s.

SMPTE

The Society of Motion Picture and Television Engineers is a professional organization which has done tremendous work in setting standards for both the film and television industries. The term "SMPTE" is also shorthand for one particular component video format - luminance and color difference.

Single Mode

A Single mode (or mono mode) optical fiber carries an optical signal on a very small diameter (9 micron) core surrounded with cladding. The small diameter means that no internally reflected lightwaves will be propagated. Thus only the original "mode" of the signal passes down the fiber. A single mode fiber used in an optical SDI system can carry a signal for up to 20 kilometers. Single mode fibers require particular care in their installation due to the extremely small optical aperture that they present at splice and connection points. See also Multi-mode.

TBC

A Time Base Corrector is a system to reduce the Time Base Error in a signal to acceptable levels. It accomplishes this by using a FIFO (First In, First Out) memory. The incoming video is written into the memory using its own jittery timing. This operation is closely associated with the actual digitization of the analog signal because the varying position of the sync timing must be mimicked by the sampling function of the analog to digital converter. A second timing system, genlocked to a stable reference,

is used to read the video back out of the memory. The memory acts as a dynamically adjusting delay to smooth out the imperfections in the original signal's timing. Very often a TBC will also function as a Frame Synchronizer. See also Frame Sync.

Time Base Error

Time base error is present when there is excessive jitter or uncertainty in the line to line output timing of a video signal. This is commonly associated with playback from video tape recorders, and is particularly severe with consumer type heterodyne systems like VHS. Time base error will render a signal unusable for broadcast or editing purposes.

Timecode

Timecode, a method to uniquely identify and label every frame in a video stream, has become one of the most recognized standards ever developed by SMPTE. It uses a 24 hour clock, consisting of hours, minutes, seconds, and television frames. Originally recorded on a spare audio track, this 2400 baud signal was a significant contributor to the development of video tape editing. We now refer to this as LTC or Longitudinal Time Code because it was carried along the edge of the tape. This allowed it to be recovered in rewind and fast forward when the picture itself could not. Timecode continues to be useful today and is carried in the vertical interval as VITC, and as a digital packet as DVITC. Timecode is the true metadata.

Tri-Level Sync

For many, many years, television systems used composite black as a genlock reference source. This was a natural evolution from analog systems to digital implementations. With the advent of High Definition television, with even higher data rates and tighter jitter requirements, problems with this legacy genlock signal surfaced. Further, a reference signal with a 50 or 60 Hz frame rate was useless with 24 Hz HD systems running at film rates. Today we can think of composite black as a bi-level sync signal – it has two levels, one at sync tip and one at blanking. For HD systems, Tri-Level Sync, which has the same blanking level (at ground) of bi-level sync, but the sync pulse now has both a negative and a positive element. This keeps the signal symmetrically balanced so that its DC content is zero. And it also means that the timing pickoff point is now at the point where the signal crosses blanking and is no longer subject to variation with amplitude. This makes Tri-Level Sync a much more robust signal and one which can be delivered with less jitter.

USB

The Universal Serial Bus, developed in the computer industry to replace the previously ubiquitous RS-232 serial interface, now appears in many different forms and with many different uses. It actually forms a small local area network, allowing multiple devices to coexist on a single bus where they can be individually addressed and accessed.

VGA

Video Graphics Array. Traditional 15-pin, analog interface between a PC and monitor.

Word Clock

Use of Word Clock to genlock digital audio devices developed in the audio recording industry. Early digital audio products were interconnected with a massive parallel connector carrying a twisted pair for every bit in the digital audio word. A clock signal, which is a square wave at the audio sampling frequency, is carried on a 75 ohm coaxial cable. Early systems would daisychain this 44.1 or 48 kilohertz clock from one device to another with coax cable and Tee connectors. On the rising edge of this Word Clock these twisted pairs would carry the left channel, while on the falling edge, they would carry the right channel. In most television systems using digital audio, the audio sample clock frequency (and hence the 'genlock' between the audio and video worlds) is derived from the video genlock signal. But products that are purely audio, with no video reference capability, may still require Word Clock.

WSS

Wide Screen Signaling is used in the PAL/625 video standards, both in analog and digital form, to convey information about the aspect ratio and format of the transmitted signal. Carried in the vertical interval, much like closed captioning, it can be used to signal a television receiver to adjust its vertical or horizontal sizing to reflect incoming material. Although an NTSC specification for WSS exists, it never achieved any traction in the marketplace.

YUV

Strictly speaking, YUV does not apply to component video. The letters refer to the Luminance (Y), and the U and V encoding axes using in the PAL composite system. Since the U axis is very close to the B-Y axis, and the V axis is very close to the R-Y axis, YUV is often used as a sort of shorthand for the more long-winded "Y/R-Y/B-Y".

Y/Cr/Cb

In digital component video, the luminance component is Y, and the two color difference signals are Cr (R-Y) and Cb (B-Y).

Y/Pr/Pb

In analog component video, the image is carried in three components. The luminance is Y, the R-Y color difference signal is Pr, and the B-Y color difference signal is Pb.